

## COMPANY PROFILE

PRL Corporation enthusiastically announces our Aluminum division,

PRL Aluminum Architectural Products

The creation of PRL Aluminum will complement our Architectural Tempered Glass Division. This new venture will allow us to service our customers with the demand of both Aluminum Products and Tempered Glass.

Our PRL team recognizes the demand and high expectations of becoming a major broad-minded player on the "convergent" architectural glass and aluminum industry.

The Aluminum division has emerged with the expertise, technology and extensive customer base inherited from PRL Glass. This advantage will make us a very strong competitive company and will allow us to unfold our true potential.

PRL Aluminum will be able to offer you,

- Aluminum Entrance Doors
- Nu Vision Entrance Doors (Herculite)
- Storefronts
- Curtainwall
- Aluminum Entrance Doors
- Sliding Doors
- IG Units
- Architectural Tempered Glass
- Brake Metal
- Custom Extruding
- Hardware

PRL Aluminum will continue to focus on our customer service satisfaction, we will stride to provide our customers with the fastest leadtimes, highest quality, most competitive pricing.



**USEFUL INFORMATION**

**FOR ORDERS OR QUOTES ON ALL DIVISION LINES**

**PLEASE CALL, (877) 775 2586**

**FAX OR E-MAIL BY DEPARTMENT,**

<b>DEPARTMENT</b>	<b>FAX</b>	<b>E-MAIL ADDRESS</b>
● <b>STOREFRONT</b>	(877) 274 8800	faststorefronts@prlaluminum.com
● <b>EXTRUSION DIVISION</b>	(877) 274 8800	fastextrusions@prlaluminum.com
● <b>ENTRANCE DOORS/ ARCHITECTURAL METALS</b>	(877) 274 8800	fastdoors@prlaluminum.com
● <b>NEW ACCOUNTS</b>	(626) 330 5918	newaccounts@prlaluminum.com
● <b>ACCOUNTING A/R</b>	(626) 330 5918	fastpay@prlaluminum.com
● <b>SALES</b>	(626) 968 8629	salesmaster@prlaluminum.com
● <b>SHIPPING</b>	(626) 968 8629	fastshipping@prlaluminum.com

**FOR IMMEDIATE ACCESS TO INFORMATION ON ALL OF OUR PRODUCT LINES**

**PLEASE VISIT OUR WEBSITE,**

**[WWW.PRLALUMINUM.COM](http://WWW.PRLALUMINUM.COM)**

**PRL SPECIALIZES IN CUSTOM ARCHITECTURAL GLASS & METAL FABRICATION.**

## **TERMS OF SALE AND CONDITIONS**

**VOLUME PRICING:** We will always welcome quotation requests for large quantities of aluminum framing, extrusions and doors. All price quotes are subject to large quantity discounts.

**QUOTES:** Quotes are good for 30 days, unless special arrangements have been made.

**MINIMUM ORDERS:**

\$75.00 minimum order

\$500.00 minimum order for free local delivery.

\$1,000.00 minimum to ship to an address other than the billing/business address.

\$1,500.00 minimum order for jobsite deliveries.

There is no delivery charge on an order, which meets the minimum charge and is within our standard delivery area and schedule.

**BACK CHARGES, CLAIMS AND DEFECTIVE MATERIAL:**

Back charges from the Buyer are not acceptable and will not be honored by the PRL Aluminum. All claims must be submitted to the PRL Aluminum within 5 days after receipt of shipment. PRL Aluminum shall have the exclusive right to select the final remedy for defective material, which will be expressly limited to the repair, replacement or the repayment of the original purchase price paid by the Buyer upon return of the material to the PRL Aluminum. Under no circumstances will any job site repairs, replacements made or labor charges for the same be accepted. There are no other warranties expressed or implied. PRL Aluminum shall not be liable for any penal, incidental or consequential damages.

**CANCELLATIONS AND RETURNS:**

Cancellation and return of custom orders will result in substantial cost to the Buyer. Return or cancellation of stock items may be made after PRL Aluminum has issued prior written authorization. Any standard stock material received in a resalable condition will be credited based on a 20% restocking charge of PRL Aluminum's sale price. All freight charges on returned goods must be paid by the customer.

**PACKING/SHIPPING:** All items are shipped F.O.B. PRL Aluminum's plant and the Buyer shall bear the risk of loss and shall in such circumstances be limited solely to an action against carriers or third parties other than PRL Aluminum. We will ship all orders via best available transportation facilities unless specified otherwise by the Buyer. Items omitted from the original shipment due to shortage of material, or other causes beyond the control of the company, will be shipped A.S.A.P.

Note: Wooden crates or cardboard wrap are available.

**EXPEDITING CHARGES:** all special leadtime requests are subject to a minimum 15% charge

**ALL PRICES ARE SUBJECT TO CHANGE WITHOUT NOTICE**

**TERMS OF SALE AND CONDITIONS**

**TERMS OF CREDIT:**

Credit must be established prior to delivery of merchandise. Orders must be delivered C.O.D. until credit can be approved and an open account has been established. All orders are subject to credit approval and to the acceptance by PRL Aluminum.

**TAXES:**

All orders will be charged sales tax unless a resale certificate is on file in our office. Please send exemption card with initial order.

**LIABILITY:**

Custom or special orders require a 50% deposit at time of order and always considered non-cancellable nor will any portion of the deposit be returned or credited.

**CREDIT EXTENSION:**

No credit will be extended by the Seller unless the Buyer's credit has been approved and is satisfactory at the time of shipment. The Seller reserves the right, at any time, to revoke credit extended to buyers because of Buyer's failure to pay for goods when due or for any other reason deemed sufficient by the Seller.

**LATE PAYMENT:**

Unless otherwise expressly provided, all payments are Net 30 Days after date of invoice. Seller may at any time require payment in advance or satisfactory security that invoices will be paid when due. 1 1/2% per month interest will be charged thereon from the due date until paid (18% annually).

## LIMITED WARRANTY AND REMEDY

PRL Aluminum Inc. warrants its product for a period of one (1) year from date of shipment against defective workmanship in manufacturing provided the product is installed in accordance with PRL Aluminum Inc. instructions and has not been damaged and/or altered prior to or during installation. PRL Aluminum Inc. will replace all products found to be so defective. The product supplied shall meet the standard door specifications as outlined in the PRL Aluminum Inc. catalog, which have been designed in accordance with prevailing engineering practices and procedures. Buyer remedies with respect to PRL Aluminum Inc failure to meet the foregoing warranties shall be limited to the sole remedy provided herein.

All items, including without limitation hardware and glass, manufactured by others and purchased by PRL Aluminum Inc for use in its products, carry such other manufacturers' warranties only. In replacing such defective items, PRL Aluminum Inc will not assume charges for freight and/or labor. All items furnished by or on behalf of buyer for incorporation of this order must be shipped to PRL Aluminum Inc plant before PRL Aluminum Inc is obligated to commence fabrication. PRL Aluminum Inc will not accept back charges for material and/or labor due to inaccuracies caused by the use of templates for cutouts and fabrication.

PRL Aluminum Inc makes no other representations, covenants, warranties or guarantees with respect to the product and performance ordered herein except as expressly set forth in this section. All implied warranties, including without limitations, merchantability, fitness for particular purpose, or arising from a course of dealing or usage of trade, are specifically excluded. Notwithstanding any provision in this agreement to the contrary, PRL Aluminum Inc in no event shall be liable to buyer for any direct, indirect, special or consequential damages, however arising, including, by way of example, but not by way limitation, loss of profit, loss of use, business interruption, or caused by the sole negligence of PRL Aluminum Inc.

## ANODIZING INFORMATION

Anodizing services for finishing aluminum alloys employ electrolytic oxidation of the aluminum surface to produce a protective oxide coating. The anodic coating consists of hydrated aluminum oxide. It is considered resistant to corrosion and abrasion. Conventional coatings are 0.1 to 1.0 mil thick and are mostly transparent, but may be colored. Anodizing services preserves the natural luster, and texture of the metal itself. An anodized coating is hard, durable, will never peel, and, under normal conditions, will never wear through. This category includes hard coat anodizing services.

Anodizing will protect the aluminum parts by making the surface much harder than natural aluminum. Aluminum oxide is grown out of the surface during anodizing and then becomes aluminum hydrate that is extremely hard. The porous nature of the anodized layer allows the product to be dyed any color that is required. Anodized will become slightly larger by about .0004 to .0009 Depend on Class.

Class I coating is a high performance anodic finish used primarily for exterior building products and other products that must withstand continuous outdoor exposure.

Class II coating is a commercial anodic finish recommended for interior applications or light exterior applications receiving regularly scheduled cleaning and maintenance such as storefronts.

Coating thickness can be measured by an "eddy current", a nondestructive test instrument, or by cutting a cross-section of the anodized aluminum, mounting it in a slide, polishing the edge, and reading the coating thickness directly with a microscope.

Class Class II coatings and I should not be confused with Type I, Type II, and Type III anodic coatings as described in the authoritative anodizing standard, MIL-A-8625. Type I anodize refers to chromic acid anodizing. Type II is normal "clear" sulfuric acid anodizing. Type III is "hard coat" using sulfuric acid or mixed chemistry electrolytes.

Coating Weight Specification:

Class I >+ 15.5 mg/in<sup>2</sup>  
Class II >= 27.0 mg/in<sup>2</sup>

Coating Density:

Class I k II >= 38.0 mg/in<sup>3</sup>

Standard Anodizing

CL Clear (In Stock)  
BR Bronze (In Stock)  
BL Black (On Request)  
GL Gold (On Request)

Note: All others different anodizing color will be consider as a Special and have a special price

We have three different type of anodizing

Class II (Standard)  
Class I (Minimum charges may apply, and has different price)  
Commercial





**201 SERIES**  
2" x 4 1/2"  
SECTION

**201 SERIES**  
2" x 4 1/2"  
SECTION

**ALUMINUM STOREFRONTS  
PL-201 SERIES**

**PART 1 GENERAL**

1.1 SECTION INCLUDES

- A. Aluminum storefronts.

1.2 REFERENCES

- A. ASTM International (ASTM):
  1. ASTM B 221 - Standard Specification for Aluminum and Aluminum-Alloy Extruded Bars, Rods, Wire, Profiles, and Tubes.
  2. ASTM E 283 - Test Method for Determining the Rate of Air Leakage Through Exterior Windows, Curtain Walls, and Doors under Specified Pressure Differences across the Specimen.
  3. ASTM E 330 - Standard Test Method for Structural Performance of Exterior Windows, Doors, Skylights and Curtain Walls by Uniform Static Air Pressure Difference.
  4. ASTM E 331 - Test Method for Water Penetration of Exterior Windows, Curtain Walls, and Doors by Uniform Static Air Pressure Difference.

1.3 SUBMITTALS

- A. Submit under provisions of applicable Requirements.
- B. Product Data: Manufacturer's data sheets on each product to be used, including:
  1. Preparation instructions and recommendations.
  2. Storage and handling requirements and recommendations.
  3. Installation methods.
- C. Shop Drawings: Configuration and details for installation, maintenance and operation.
- D. Selection Samples: For each finish product specified, two complete sets of color chips representing manufacturer's full range of available colors and patterns.
- E. Verification Samples: For each finish product specified, two samples, minimum size 6 inches (150 mm) square representing actual product, color, and patterns.

1.4 QUALITY ASSURANCE

- A. Manufacturer Qualifications: Minimum 5 year experience manufacturing similar products.
- B. Installer Qualifications: Minimum 2 year experience installing similar products.
- C. Mock-Up: Provide a mock-up for evaluation of surface preparation techniques and application workmanship.
  1. Finish areas designated by Architect.
  2. Do not proceed with remaining work until workmanship is approved by Architect.
  3. Refinish mock-up area as required to produce acceptable work.

1.5 PRE-INSTALLATION MEETINGS

**PL-201 - 1**

- A. Convene minimum two weeks prior to starting work of this section.

#### 1.6 DELIVERY, STORAGE, AND HANDLING

- A. Deliver and store products in manufacturer's unopened packaging bearing the brand name and manufacturer's identification until ready for installation.
- B. Handling: Handle materials to avoid damage.

#### 1.7 PROJECT CONDITIONS

- A. Maintain environmental conditions (temperature, humidity, and ventilation) within limits recommended by manufacturer for optimum results. Do not install products under environmental conditions outside manufacturer's recommended limits.

#### 1.8 SEQUENCING

- A. Ensure that products of this section are supplied to affected trades in time to prevent interruption of construction progress.

### **PART 2 PRODUCTS**

#### 2.1 MANUFACTURERS

- A. Acceptable Manufacturer: PRL Glass Systems, Inc., which is located at: 13644 Nelson Ave.; City of Industry, CA 91746; Toll Free Tel: 800-433-7044; Fax: 626-968-9256; Email: request; Web:[prlglass.com](http://prlglass.com)
- B. Substitutions: Not permitted.
- C. Requests for substitutions will be considered in accordance with provisions of Section 01 60 00 - Product Requirements.

#### 2.2 ALUMINUM STOREFRONT

- A. Product: Aluminum Storefront Series as manufactured by PRL Glass Systems, Inc.
- B. Design:
  - 1. Framing sections shall be extruded from 6063-T5 aluminum alloy.
  - 2. Glazing beads shall be NS (non-stretch, high-shore) vinyl used on both sides of the glass. Vinyl shall incorporate a fiberglass cord bonded with the vinyl.
  - 3. Sections shall conform to details and shall present clean, straight, sharply defined lines, and shall be free from defects impairing strength or durability.
  - 4. Screws, nuts, bolts and fastening devices and internal components shall be of aluminum, stainless steel or other non-corrosive material.
  - 5. Factory preparation from detail drawings shall be so fabricated that field assembly will be able to produce accurate, tightly fitted joints.
- C. **201-Series (2 X 4-1/2 Offset Glaze For 1/4 Glazing):**
  - 1. Performance: (Test sample of 10 feet (3048 mm) wide by 10 feet (3048 mm) high - 3 lites wide by 2 lites high).
    - a. Air infiltration: Limit air leakage through fixed glazing and frames to 0.045 cfm/ft<sup>2</sup>/min when tested in accordance with ASTM E-283 at a cross pressure of 6.24 psf (0.30 kPa).
    - b. Water Penetration under Static Pressure: System shall not evidence uncontrolled water penetration at a cross pressure of 6 psf (0.29 kPa) when tested in accordance with ASTM-E331-00.
    - c. Uniform Load Structural per ASTM E 330: Limit deflection to L/175.

### **PL-201 - 2**

- 1) Passed at Design Pressure of 20 psf (0.96 kPa).

## **PART 3 EXECUTION**

### 3.1 EXAMINATION

- A. Do not begin installation until substrates have been properly prepared.
- B. If substrate preparation is the responsibility of another installer, notify Architect of unsatisfactory preparation before proceeding.

### 3.2 PREPARATION

- A. Clean surfaces thoroughly prior to installation.
- B. Prepare surfaces using the methods recommended by the manufacturer for achieving the best result for the substrate under the project conditions.

### 3.3 INSTALLATION

- A. Install in accordance with manufacturer's instructions.

### 3.4 FIELD QUALITY CONTROL

- A. All joints between metal and masonry shall be fully caulked and field tested to resist water leakage with provisions taken to drain infiltrated water.

### 3.5 PROTECTION

- A. Protect installed products until completion of project.
- B. Touch-up, repair or replace damaged products before Substantial Completion.

END OF SECTION



**PL-201 SERIES**  
**2" X 4-1/2"**  
**1/4" OFFSET GLAZED**

**PL-201 SERIES**  
 STOREFRONT MATERIAL



**SCREW RACE**

**QUICK SET**

**SCREW RACE**

**QUICK SET**

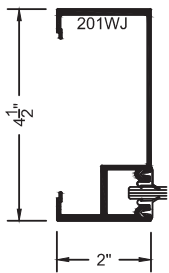
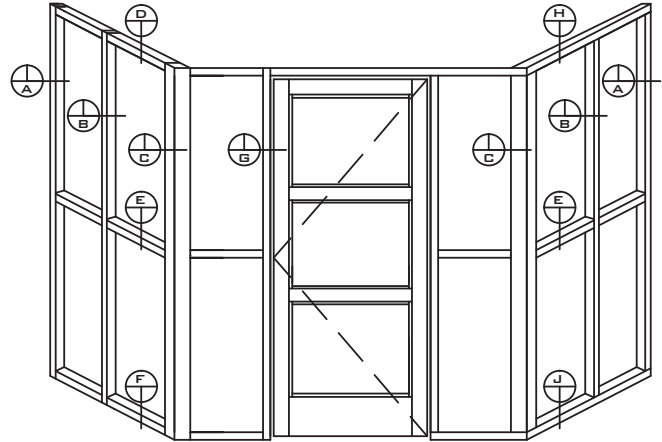
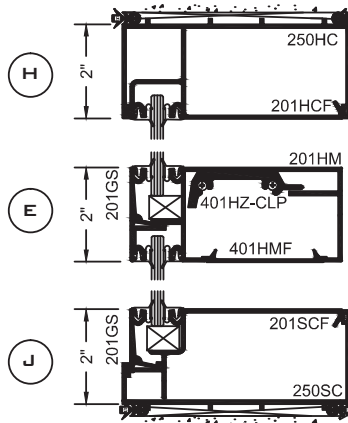
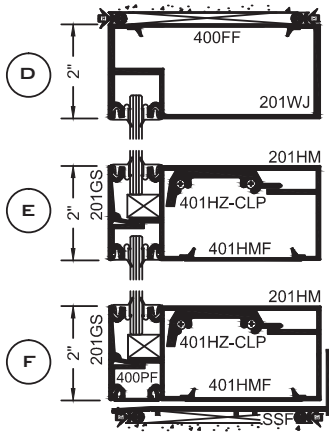

(A-1)

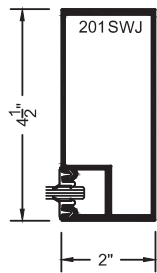

(A-2)

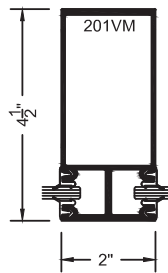

(B-1)

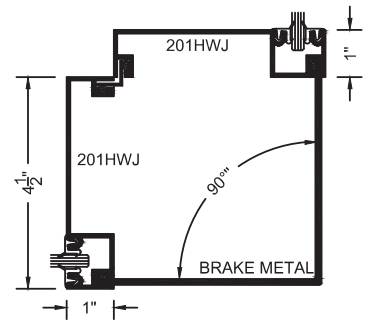

(C-1)

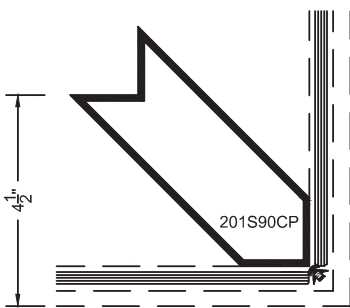

(C-2)

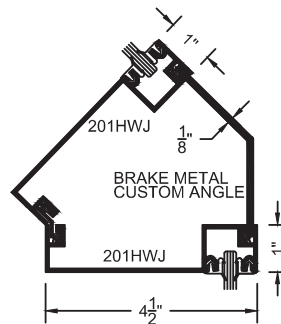

(C-3)

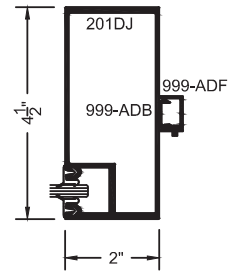

(E-1)

**PL-201 - 4**

ph: (877) 775-2586  
 fx: (877) 274-8800

14760 Don Julian Rd.  
 Industry, CA 91746

www.prlaluminum.com  
 sales@prlaluminum.com

PL-201 SERIES  
 2" X 4-1/2"  
 FULL SCALE

QUICK SET

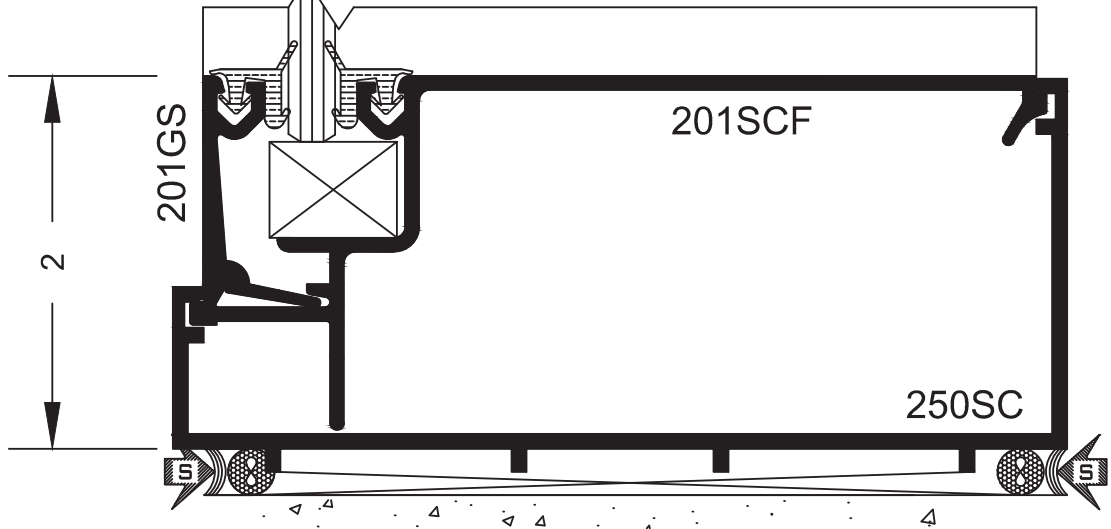
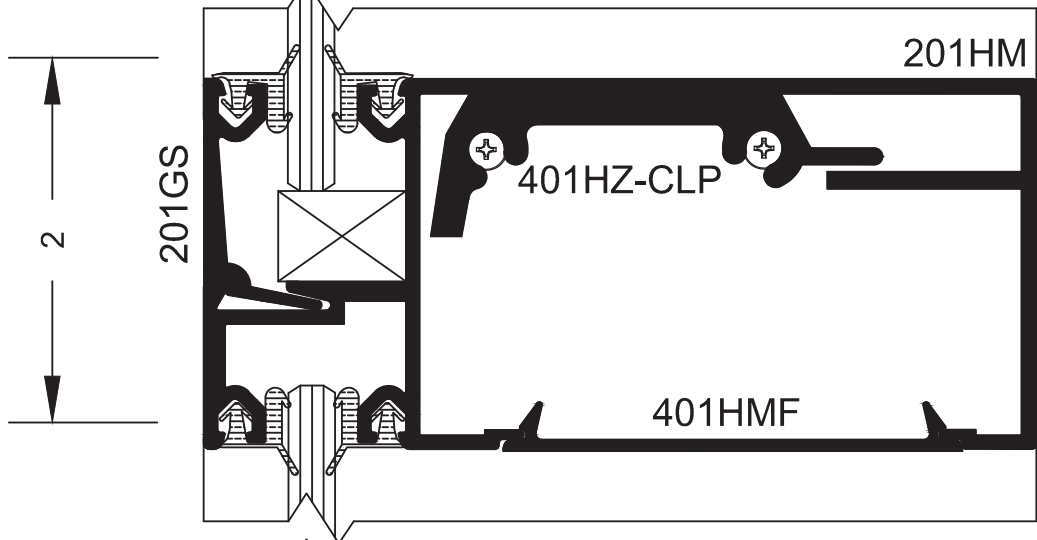
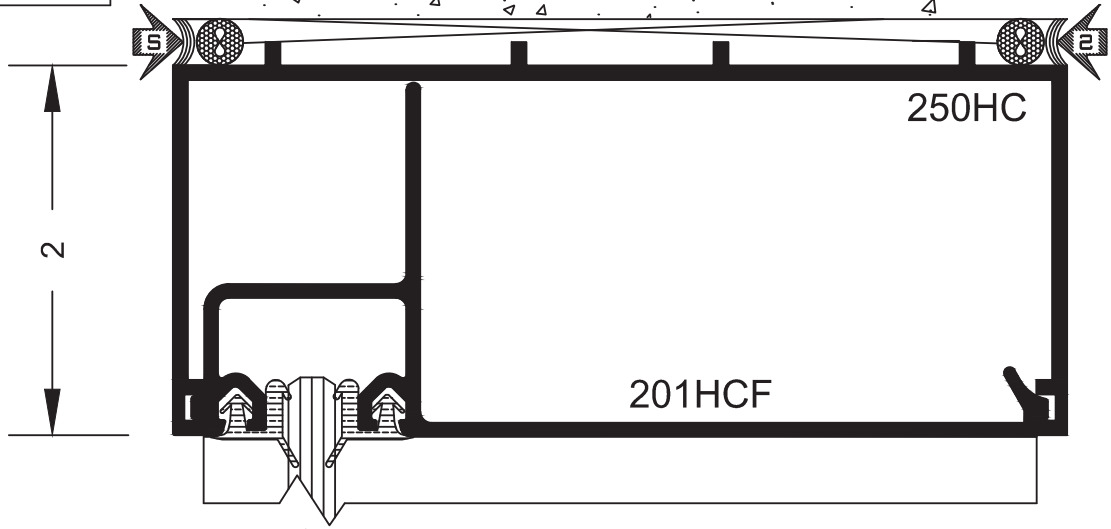

PL-201 - 5

ph: (877) 775-2586  
 fx: (877) 274-8800

14760 Don Julian Rd.  
 Industry, CA 91746

www.prlaluminum.com  
 sales@prlaluminum.com



PL-201 SERIES  
 2" X 4-1/2"  
 FULL SCALE

SCREW RACE



D

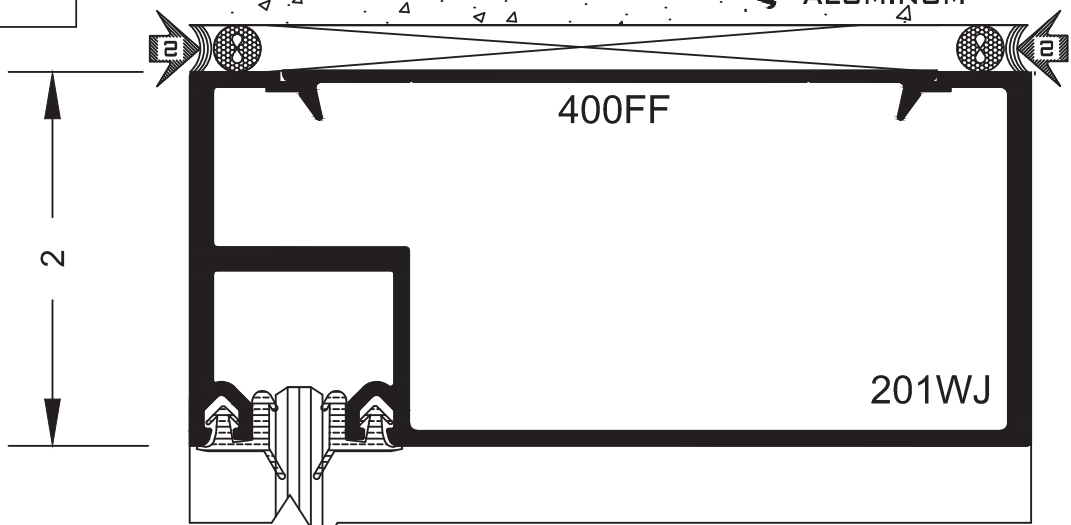

E

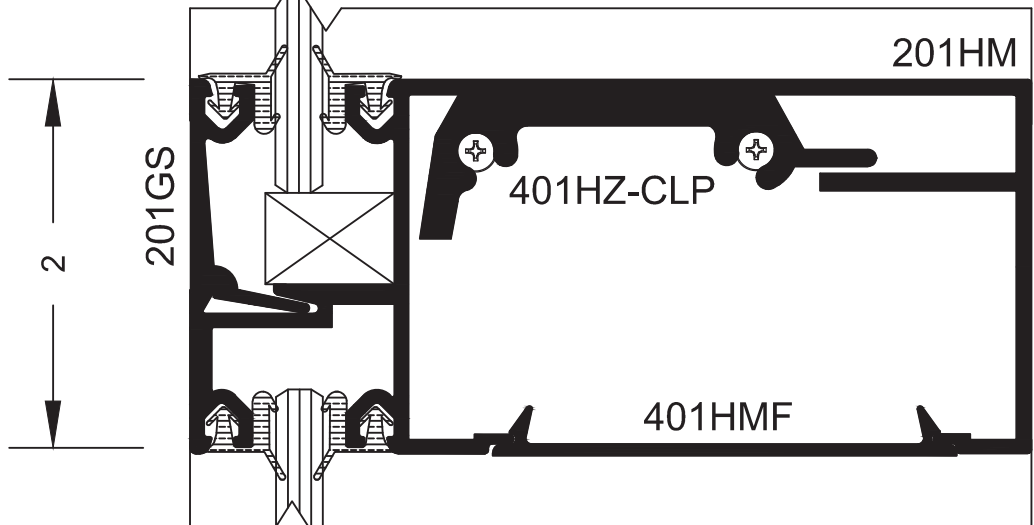

F

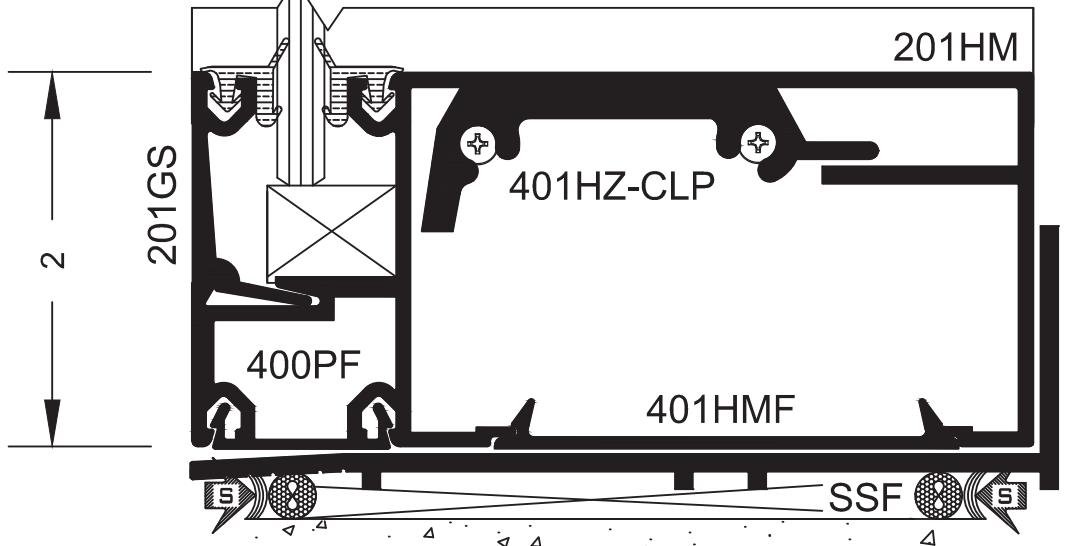

PL-201 - 6

ph: (877) 775-2586  
 fx: (877) 274-8800

14760 Don Julian Rd.  
 Industry, CA 91746

www.prlaluminum.com  
 sales@prlaluminum.com

PL-201 SERIES  
2" X 4-1/2"  
FULL SCALE

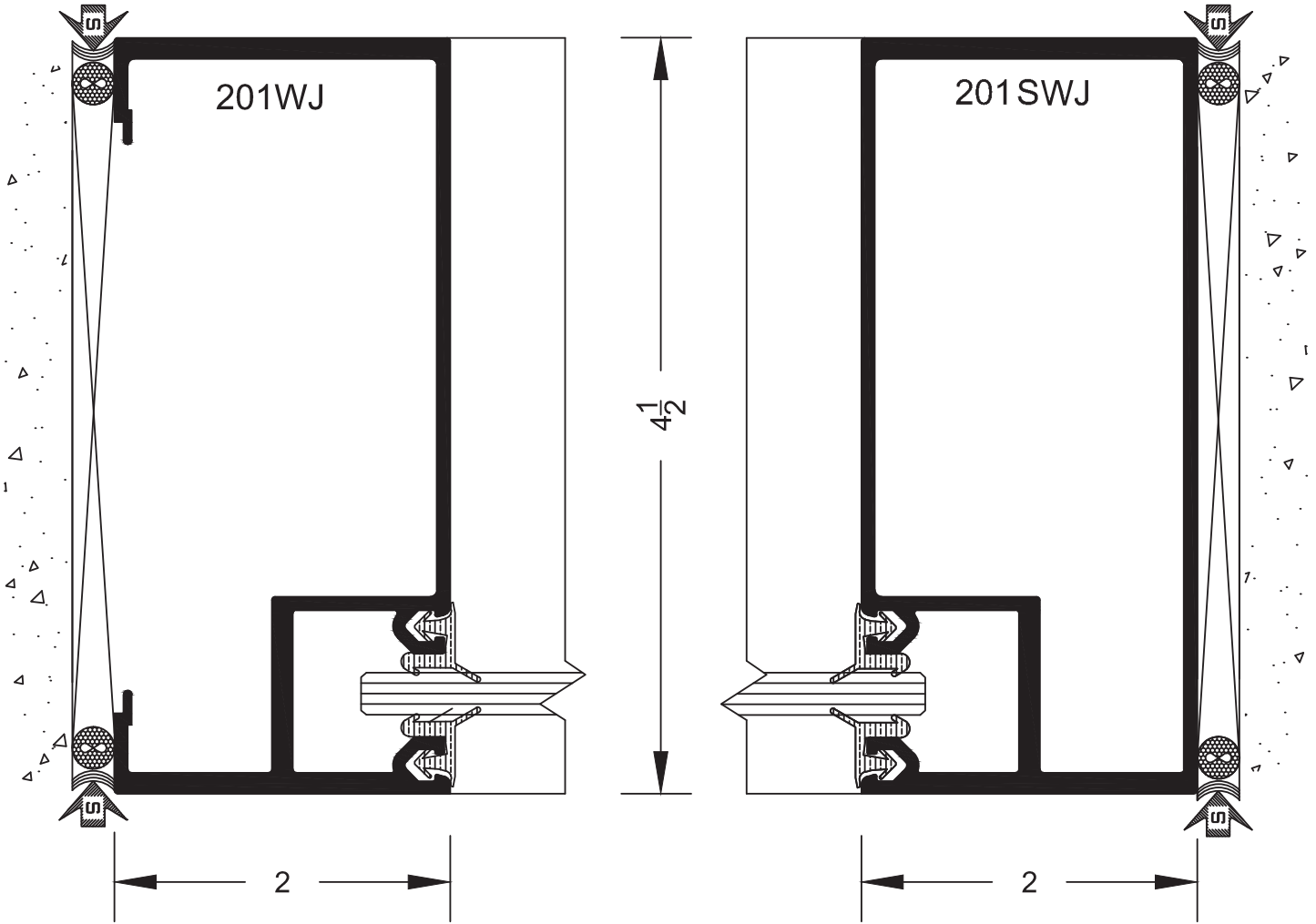

A-1

A-2

ph: (877) 775-2586  
fx: (877) 274-8800

PL-201 - 7  
14760 Don Julian Rd.  
Industry, CA 91746

www.prlaluminum.com  
sales@prlaluminum.com

**PL-201 SERIES**  
**2" X 4-1/2"**  
**FULL SCALE**

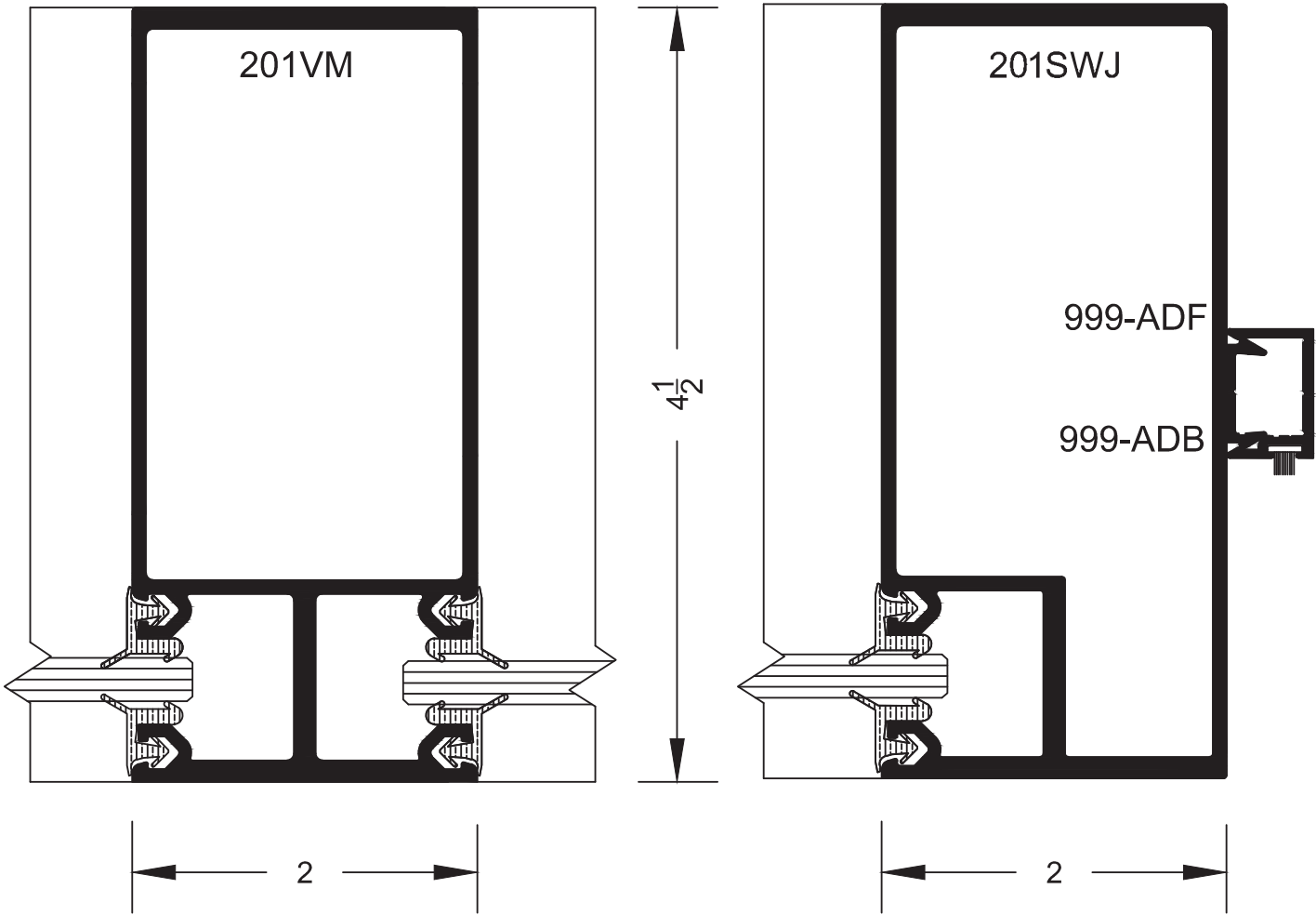

**B-1**

**G-1**

PL-201 SERIES  
2" X 4-1/2"  
FULL SCALE

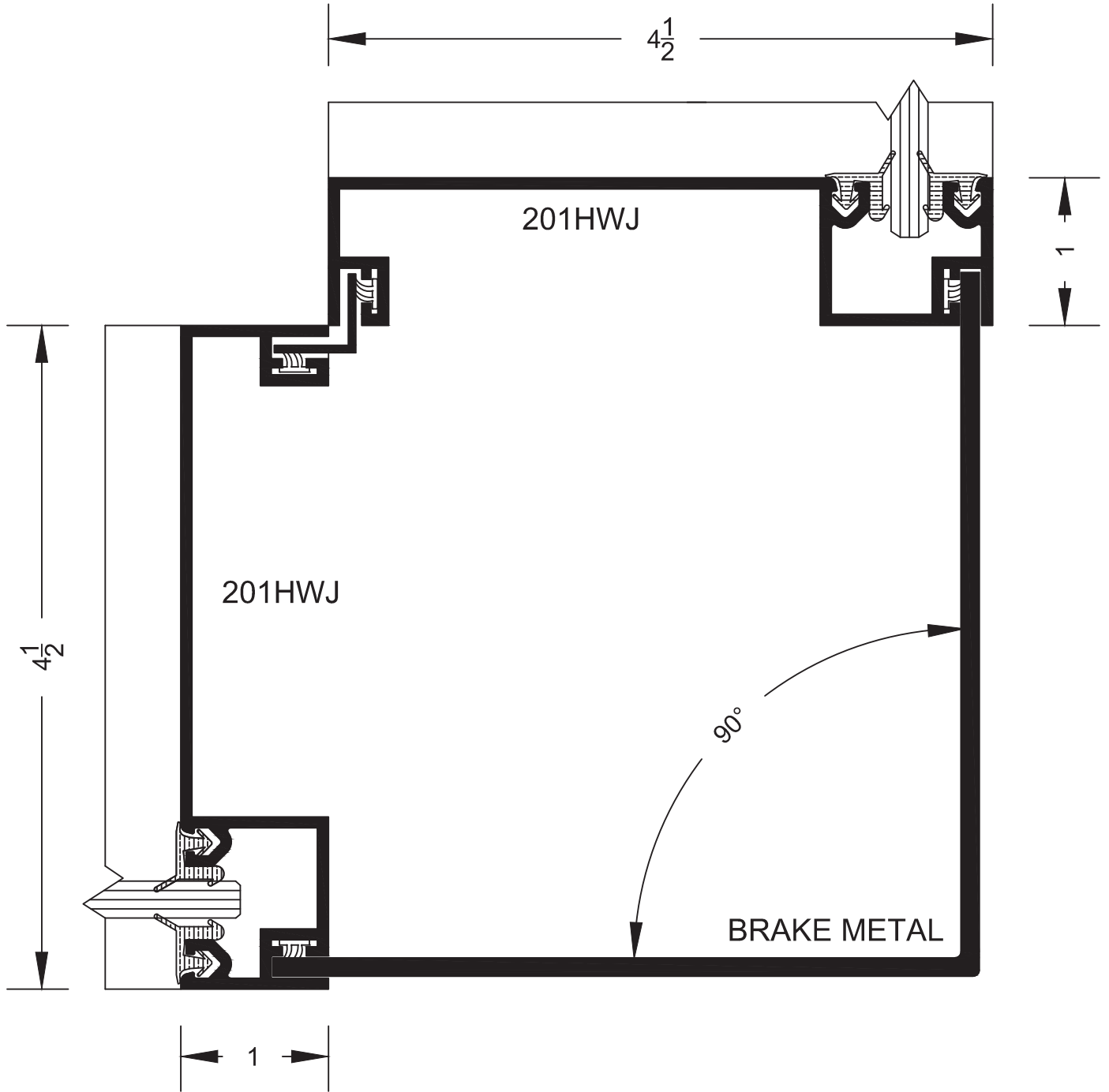

C-1

PL-201 SERIES  
2" X 4-1/2"  
FULL SCALE

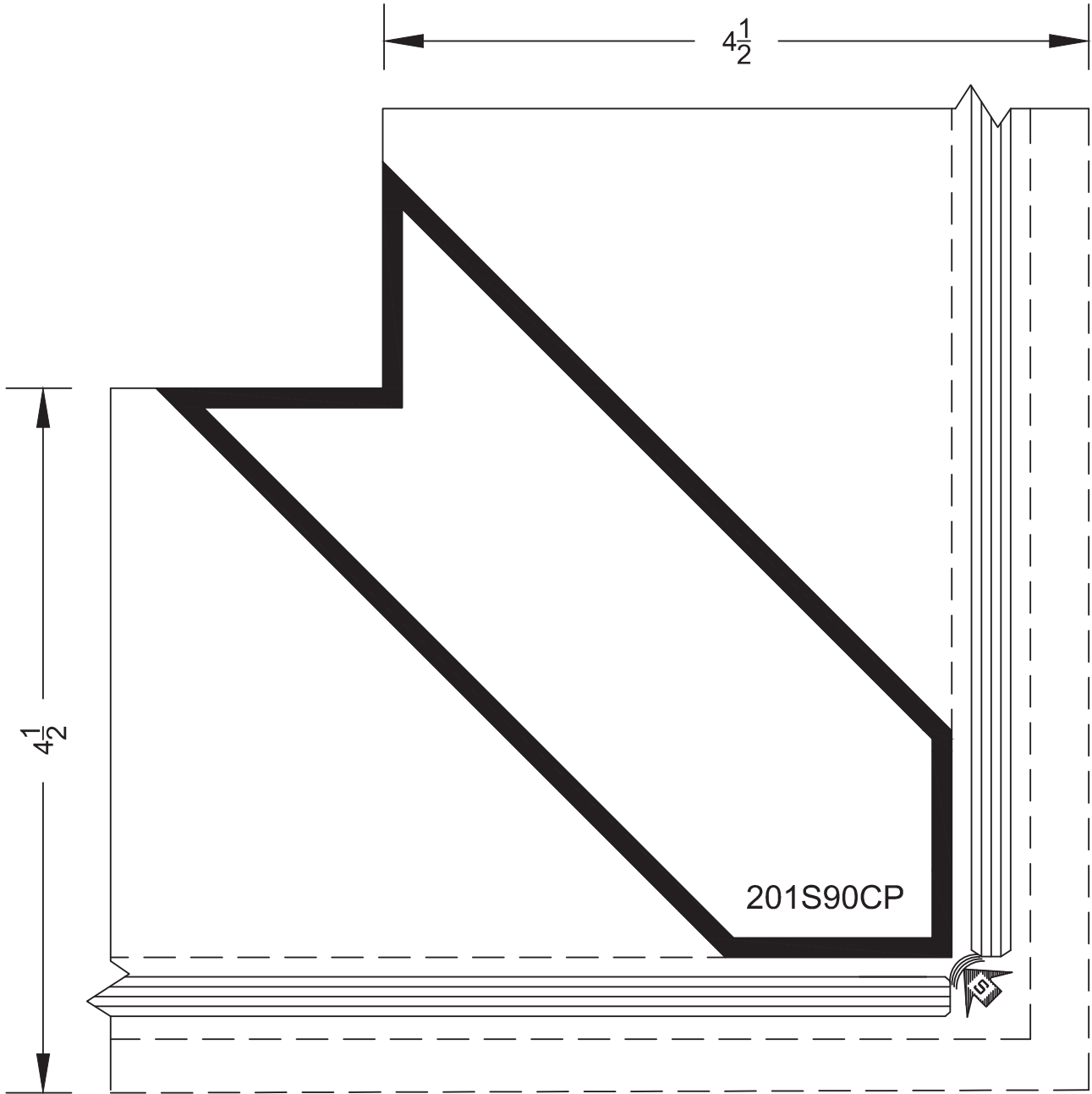

C-2

PL-201 SERIES  
2" X 4-1/2"  
FULL SCALE

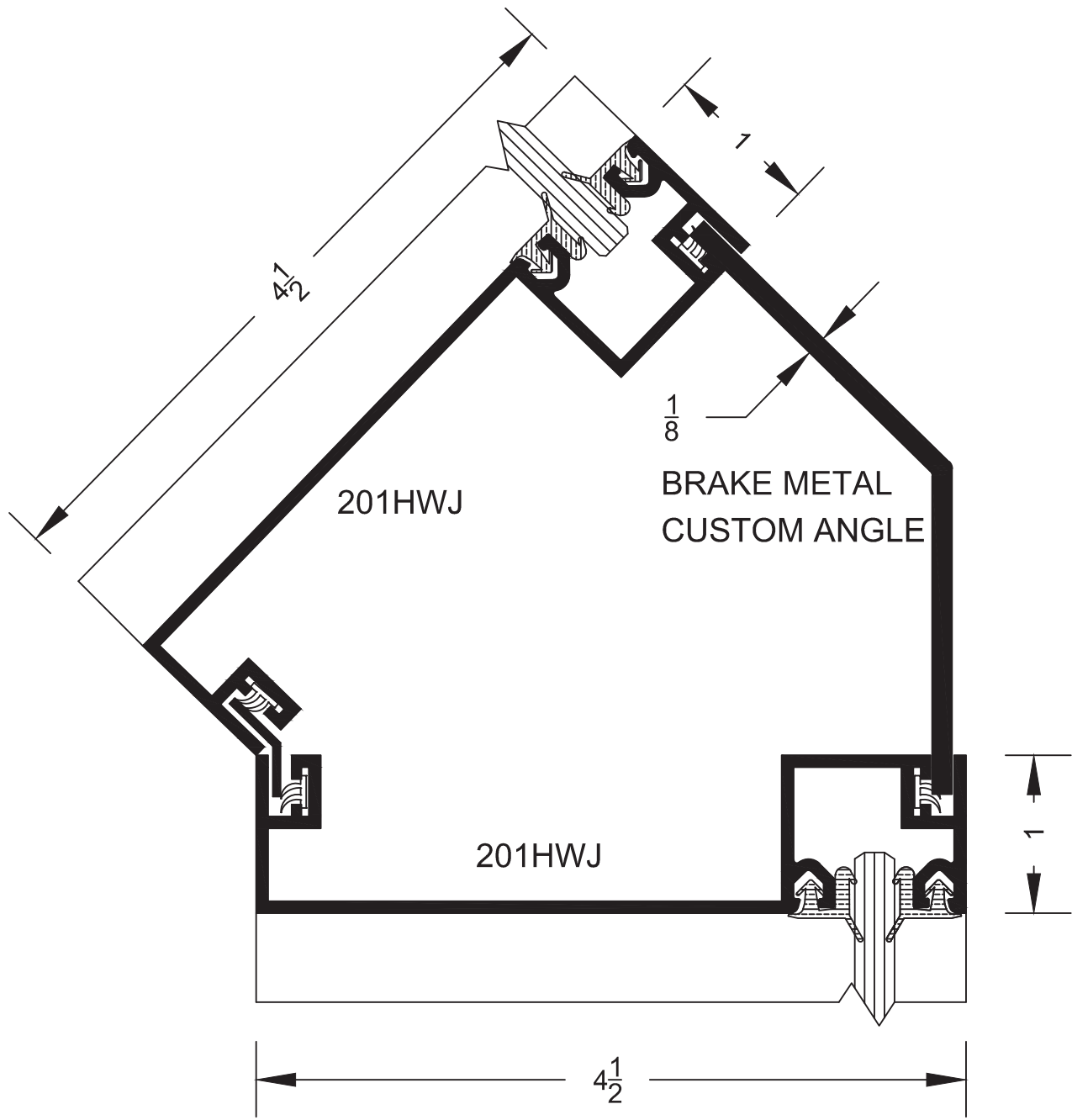

C-3

ph: (877) 775-2586  
fx: (877) 274-8800

PL-201 - 11  
14760 Don Julian Rd.  
Industry, CA 91746

www.prlaluminum.com  
sales@prlaluminum.com

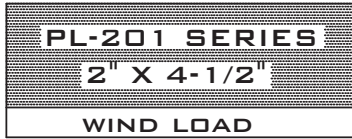

## WIND LOAD DESIGN

GLAZING FRAMING SHALL BE DESIGNED NOT TO EXCEED L/175, RATIO CURVES SHALL REPRESENT LIMIT.

VALUES ARE BASED ON CRITERIA FOR SIMPLE BEAM UNIFORMLY LOADED.

ALLOWABLE STRESSES FOR 6063-T5 ALUMINUM ALLOY = 9500 P.S.I.  
ALLOWABLE STRESSES FOR A-36 STRUCTURAL STEEL = 21600 P.S.I.

MAXIMUM DEFLECTION BETWEEN SUPPORTS FOR SINGLE SPAN:

$$\Delta = \frac{5WL^3}{384EI}$$

MAXIMUM BENDING MOMENT FOR SINGLE SPAN:

$$M = \frac{WL}{8}$$

NOTATIONS REPRESENT:

W = TOTAL UNIFORM LOAD

L = LENGTH OF MULLION BETWEEN SUPPORTS

E =  $10 \times 10^6$  P.S.I.

I = MOMENT OF INERTIA OF MULLION

M = BENDING MOMENT

NOTE:

MULLIONS ARE ASSUMED TO HAVE EQUAL SIZE GLASS LIGHTS EACH SIDE

**PL-201 SERIES**  
**2" X 4-1/2"**  
**WIND LOAD**



201 VERTICAL MULLION

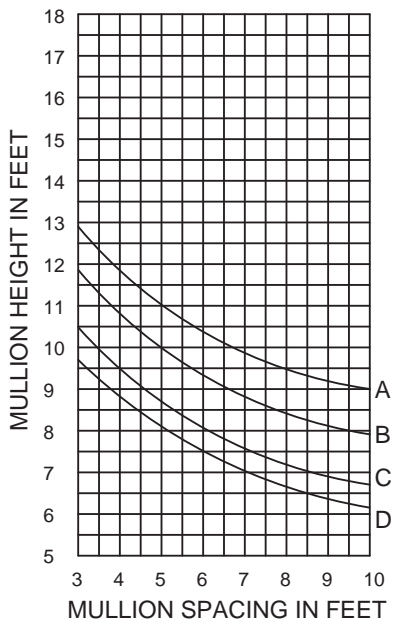

$I = 2.853 \text{ IN}^4$   
 $S = 1.347 \text{ IN}^3$



201 SOLID WALL JAMB

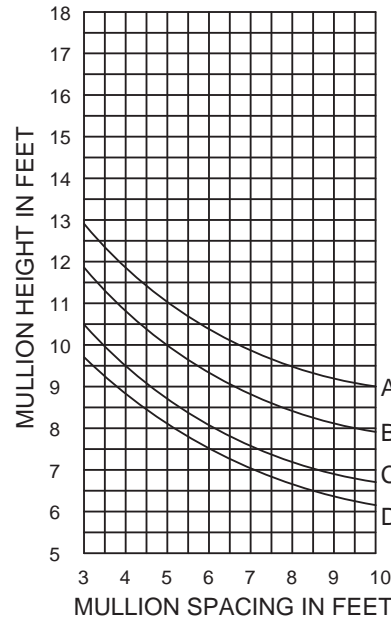

$I = 2.853 \text{ IN}^4$   
 $S = 1.347 \text{ IN}^3$

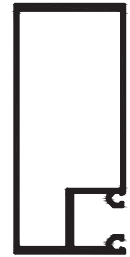

CURVE REPRESENTATION

- A = 15 P.S.F. ( 75 M.P.H )
- B = 20 P.S.F. ( 90 M.P.H )
- C = 25 P.S.F. ( 100 M.P.H )
- D = 30 P.S.F. ( 110 M.P.H )

201 VERTICAL MULLION  
 WITH STEEL REINFORCEMENT

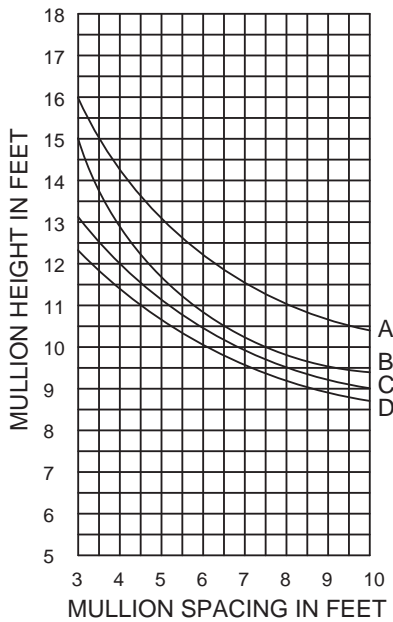

$I = 6.212 \text{ IN}^4$   
 $S = 2.933 \text{ IN}^3$

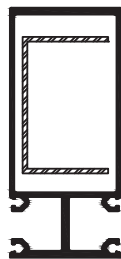

201 VERTICAL WALL JAMB

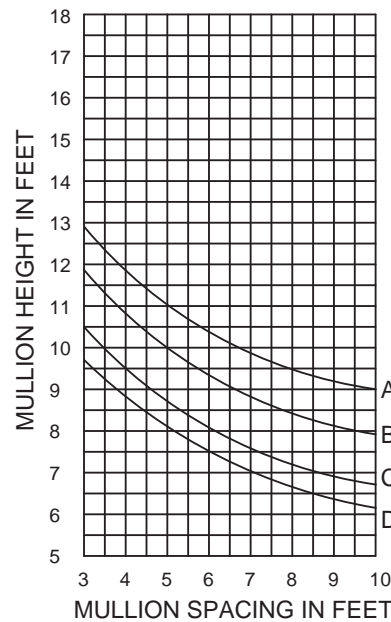

$I = 2.853 \text{ IN}^4$   
 $S = 1.347 \text{ IN}^3$





**250 SERIES**  
**2" x 4 1/2"**  
**SECTION**

**250 SERIES**  
**2" x 4 1/2"**  
**SECTION**



## ALUMINUM STOREFRONTS PL-250 SERIES

### **PART 1 GENERAL**

#### 1.1 SECTION INCLUDES

- A. Aluminum storefronts.

#### 1.2 REFERENCES

- A. ASTM International (ASTM):
  1. ASTM B 221 - Standard Specification for Aluminum and Aluminum-Alloy Extruded Bars, Rods, Wire, Profiles, and Tubes.
  2. ASTM E 283 - Test Method for Determining the Rate of Air Leakage Through Exterior Windows, Curtain Walls, and Doors under Specified Pressure Differences across the Specimen.
  3. ASTM E 330 - Standard Test Method for Structural Performance of Exterior Windows, Doors, Skylights and Curtain Walls by Uniform Static Air Pressure Difference.
  4. ASTM E 331 - Test Method for Water Penetration of Exterior Windows, Curtain Walls, and Doors by Uniform Static Air Pressure Difference.

#### 1.3 SUBMITTALS

- A. Submit under provisions of applicable Requirements.
- B. Product Data: Manufacturer's data sheets on each product to be used, including:
  1. Preparation instructions and recommendations.
  2. Storage and handling requirements and recommendations.
  3. Installation methods.
- C. Shop Drawings: Configuration and details for installation, maintenance and operation.
- D. Selection Samples: For each finish product specified, two complete sets of color chips representing manufacturer's full range of available colors and patterns.
- E. Verification Samples: For each finish product specified, two samples, minimum size 6 inches (150 mm) square representing actual product, color, and patterns.

#### 1.4 QUALITY ASSURANCE

- A. Manufacturer Qualifications: Minimum 5 year experience manufacturing similar products.
- B. Installer Qualifications: Minimum 2 year experience installing similar products.
- C. Mock-Up: Provide a mock-up for evaluation of surface preparation techniques and application workmanship.
  1. Finish areas designated by Architect.
  2. Do not proceed with remaining work until workmanship is approved by Architect.
  3. Refinish mock-up area as required to produce acceptable work.

#### 1.5 PRE-INSTALLATION MEETINGS

### PL-250 - 1

- A. Convene minimum two weeks prior to starting work of this section.

#### 1.6 DELIVERY, STORAGE, AND HANDLING

- A. Deliver and store products in manufacturer's unopened packaging bearing the brand name and manufacturer's identification until ready for installation.
- B. Handling: Handle materials to avoid damage.

#### 1.7 PROJECT CONDITIONS

- A. Maintain environmental conditions (temperature, humidity, and ventilation) within limits recommended by manufacturer for optimum results. Do not install products under environmental conditions outside manufacturer's recommended limits.

#### 1.8 SEQUENCING

- A. Ensure that products of this section are supplied to affected trades in time to prevent interruption of construction progress.

### **PART 2 PRODUCTS**

#### 2.1 MANUFACTURERS

- A. Acceptable Manufacturer: PRL Glass Systems, Inc., which is located at: 13644 Nelson Ave.; City of Industry, CA 91746; Toll Free Tel: 800-433-7044; Fax: 626-968-9256; Email: request; Web:[prlglass.com](http://prlglass.com)
- B. Substitutions: Not permitted.
- C. Requests for substitutions will be considered in accordance with provisions of Section 01 60 00 - Product Requirements.

#### 2.2 ALUMINUM STOREFRONT

- A. Product: Aluminum Storefront Series as manufactured by PRL Glass Systems, Inc.
- B. Design:
  - 1. Framing sections shall be extruded from 6063-T5 aluminum alloy.
  - 2. Glazing beads shall be NS (non-stretch, high-shore) vinyl used on both sides of the glass. Vinyl shall incorporate a fiberglass cord bonded with the vinyl.
  - 3. Sections shall conform to details and shall present clean, straight, sharply defined lines, and shall be free from defects impairing strength or durability.
  - 4. Screws, nuts, bolts and fastening devices and internal components shall be of aluminum, stainless steel or other non-corrosive material.
  - 5. Factory preparation from detail drawings shall be so fabricated that field assembly will be able to produce accurate, tightly fitted joints.
- C. **250-Series (2 X 4-1/2 Center Glaze For 1 Glazing):**
  - 1. Performance: (Test sample of 10 feet (3048 mm) wide by 10 feet (3048 mm) high - 3 lites wide by 2 lites high).
    - a. Air infiltration: Limit air leakage through fixed glazing and frames to 0.039 cfm/ft<sup>2</sup>/min when tested in accordance with ASTM E-283 at a cross pressure of 6.24 psf (0.30 kPa).
    - b. Water Penetration under Static Pressure: System shall not evidence uncontrolled water penetration at a cross pressure of 6 psf (0.29 kPa) when tested in accordance with ASTM-E331-00.
    - c. Uniform Load Structural per ASTM E 330: Limit deflection to L/175.

### **PL-250 - 2**

- 1) Passed at Design Pressure of 20 psf (0.96 kPa).

## **PART 3 EXECUTION**

### 3.1 EXAMINATION

- A. Do not begin installation until substrates have been properly prepared.
- B. If substrate preparation is the responsibility of another installer, notify Architect of unsatisfactory preparation before proceeding.

### 3.2 PREPARATION

- A. Clean surfaces thoroughly prior to installation.
- B. Prepare surfaces using the methods recommended by the manufacturer for achieving the best result for the substrate under the project conditions.

### 3.3 INSTALLATION

- A. Install in accordance with manufacturer's instructions.

### 3.4 FIELD QUALITY CONTROL

- A. All joints between metal and masonry shall be fully caulked and field tested to resist water leakage with provisions taken to drain infiltrated water.

### 3.5 PROTECTION

- A. Protect installed products until completion of project.
- B. Touch-up, repair or replace damaged products before Substantial Completion.

END OF SECTION



**PL-250 SERIES**  
**2" X 4-1/2"**  
**1" CENTER GLAZED**

**PL-250 SERIES**  
 STOREFRONT MATERIAL



**SCREW RACE**

**QUICK SET**

**SCREW RACE**

**QUICK SET**

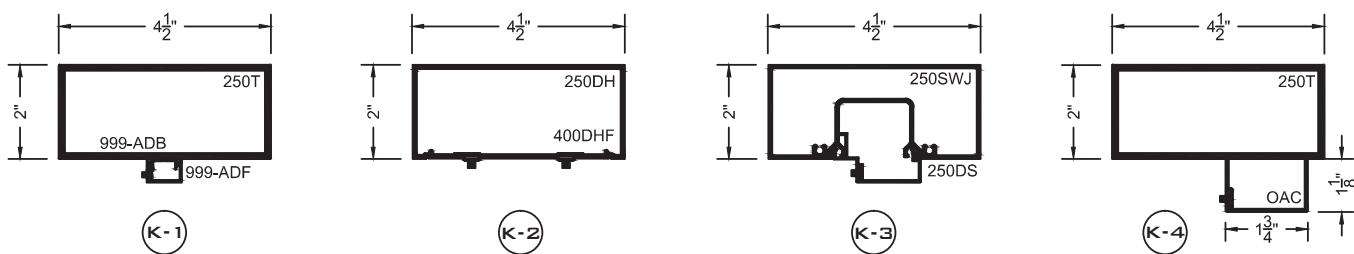
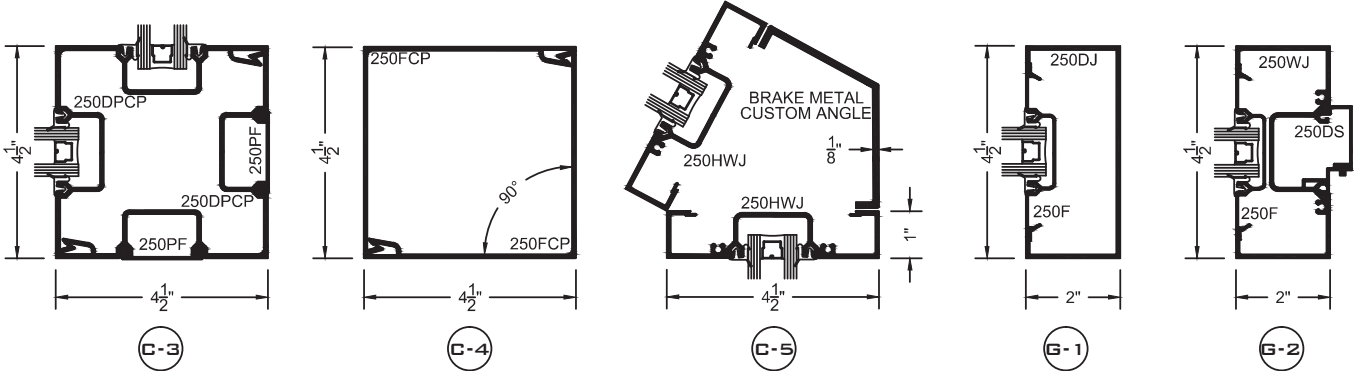
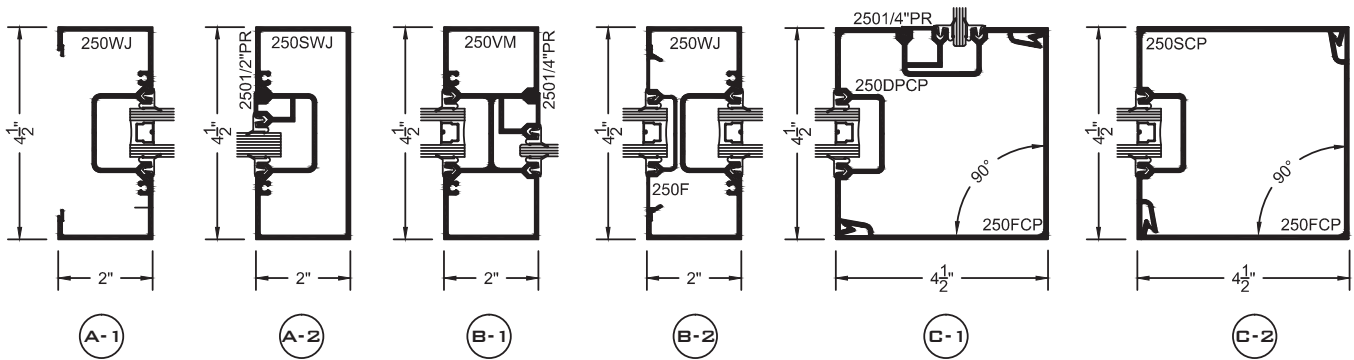
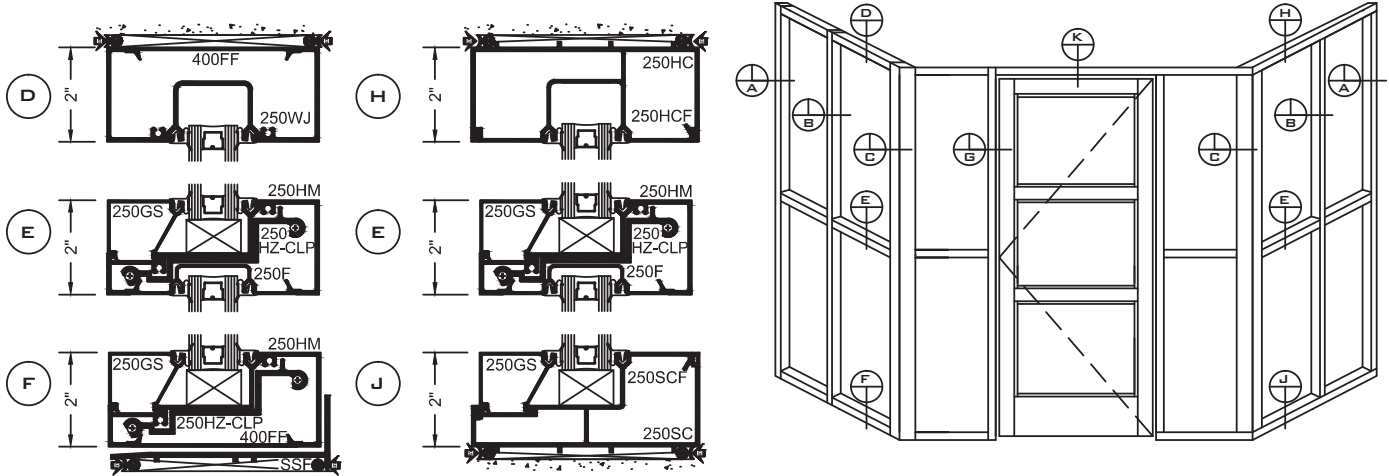

**PL-250 - 4**

ph: (877) 775-2586  
 fx: (877) 274-8800

14760 Don Julian Rd.  
 Industry, CA 91746

www.prlaluminum.com  
 sales@prlaluminum.com

**PL-250 SERIES**  
**2" X 4-1/2"**  
**FULL SCALE**

**QUICK SET**



**H**

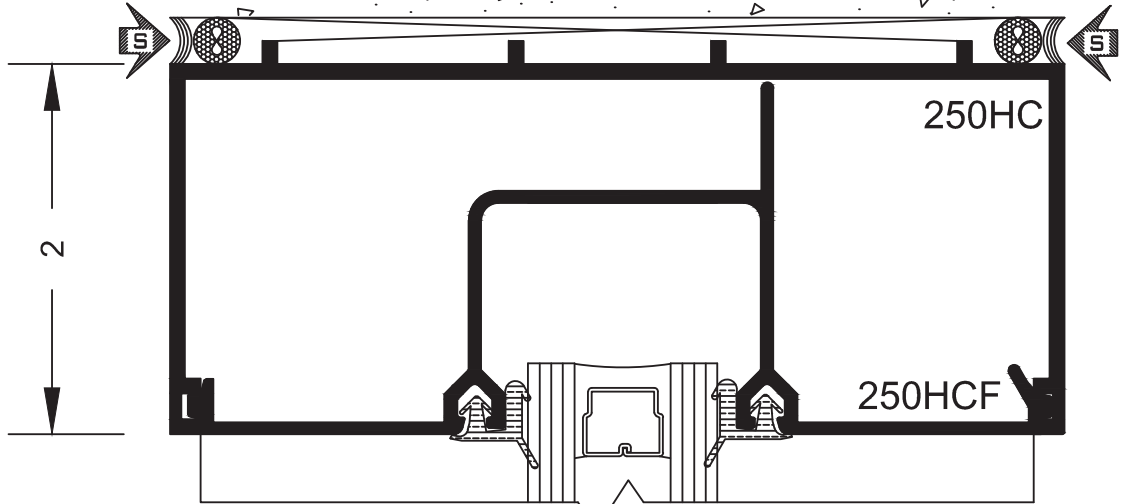

**E**

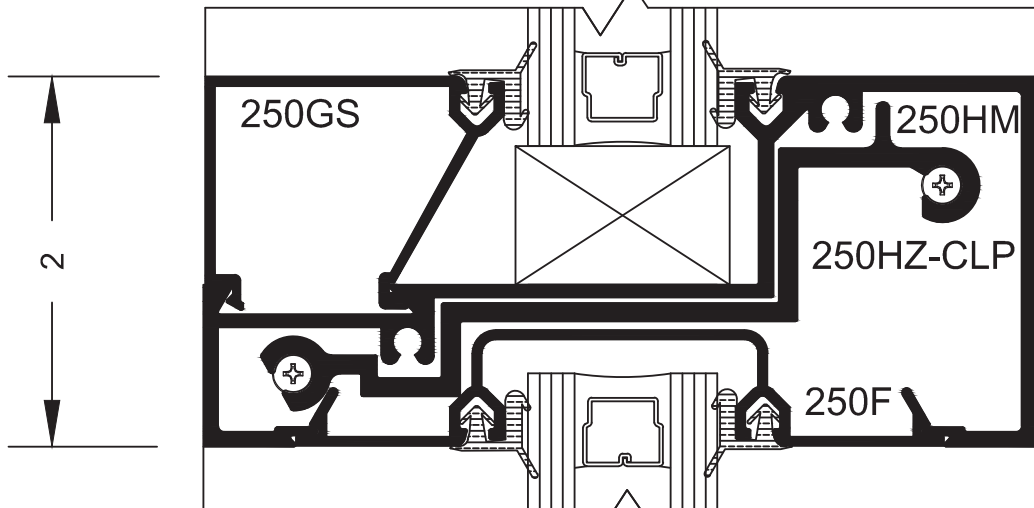

**J**

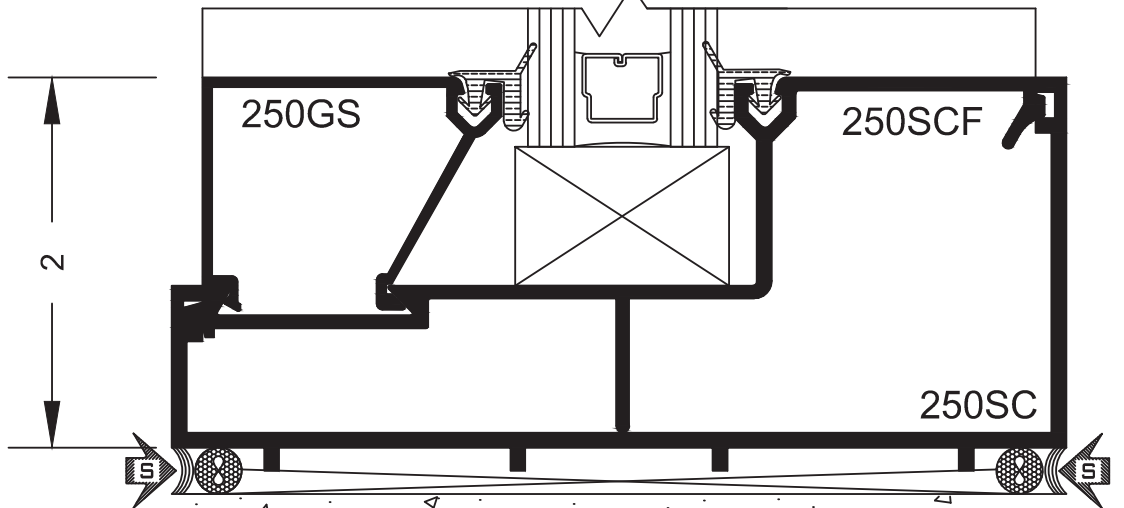

**PL-250 - 5**

ph: (877) 775-2586  
 fx: (877) 274-8800

14760 Don Julian Rd.  
 Industry, CA 91746

www.prlaluminum.com  
 sales@prlaluminum.com



**PL-250 SERIES**  
**2" X 4-1/2"**  
**FULL SCALE**

**SCREW RACE**  **PRL**  
 ALUMINUM

**D**

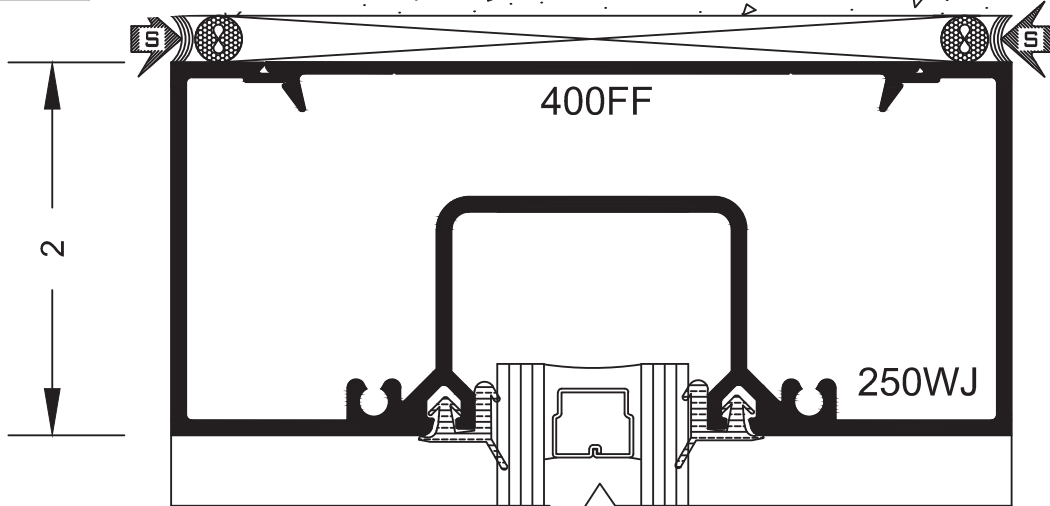

**E**

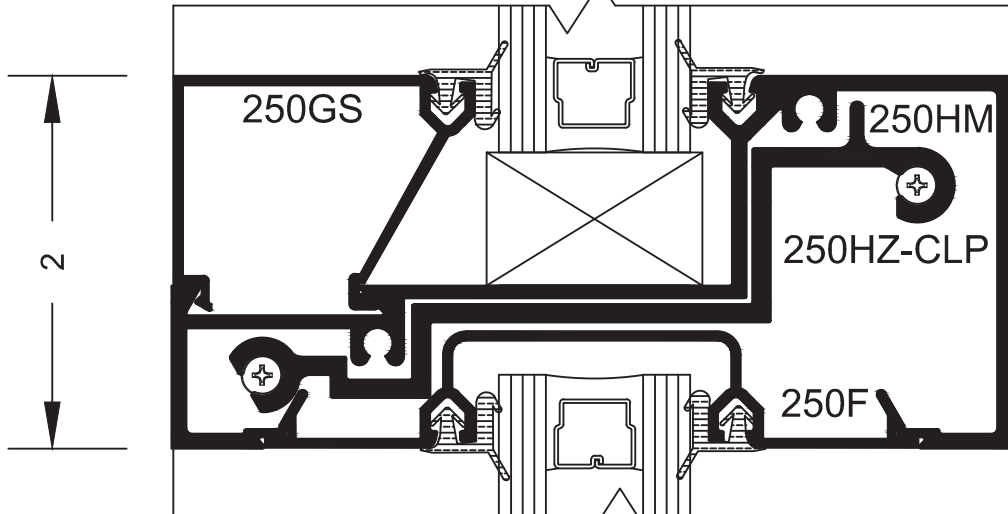

**F**

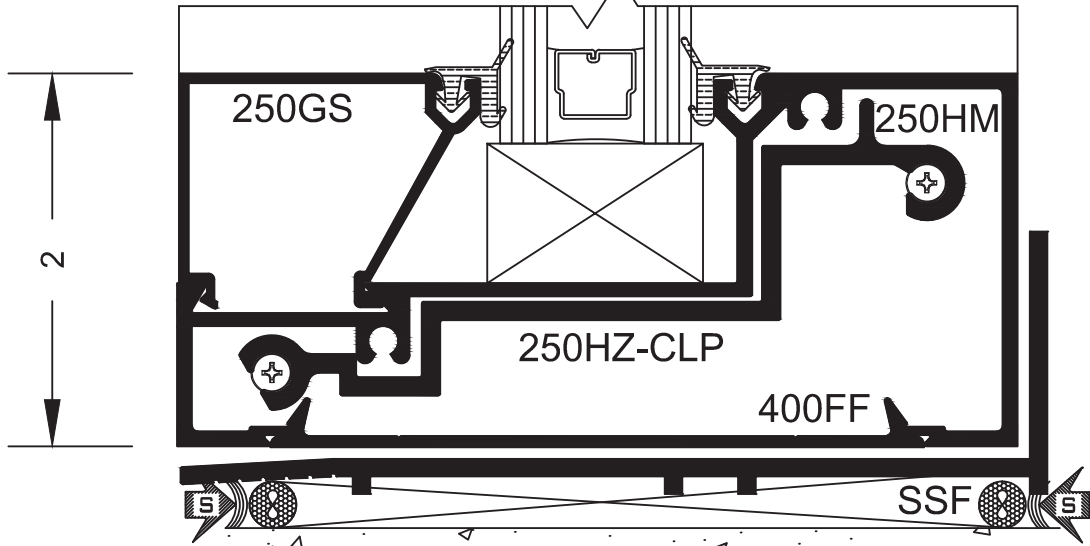

**PL-250 - 6**

ph: (877) 775-2586  
 fx: (877) 274-8800

14760 Don Julian Rd.  
 Industry, CA 91746

[www.prlaluminum.com](http://www.prlaluminum.com)  
[sales@prlaluminum.com](mailto:sales@prlaluminum.com)

**PL-250 SERIES**  
**2" X 4-1/2"**  
**FULL SCALE**

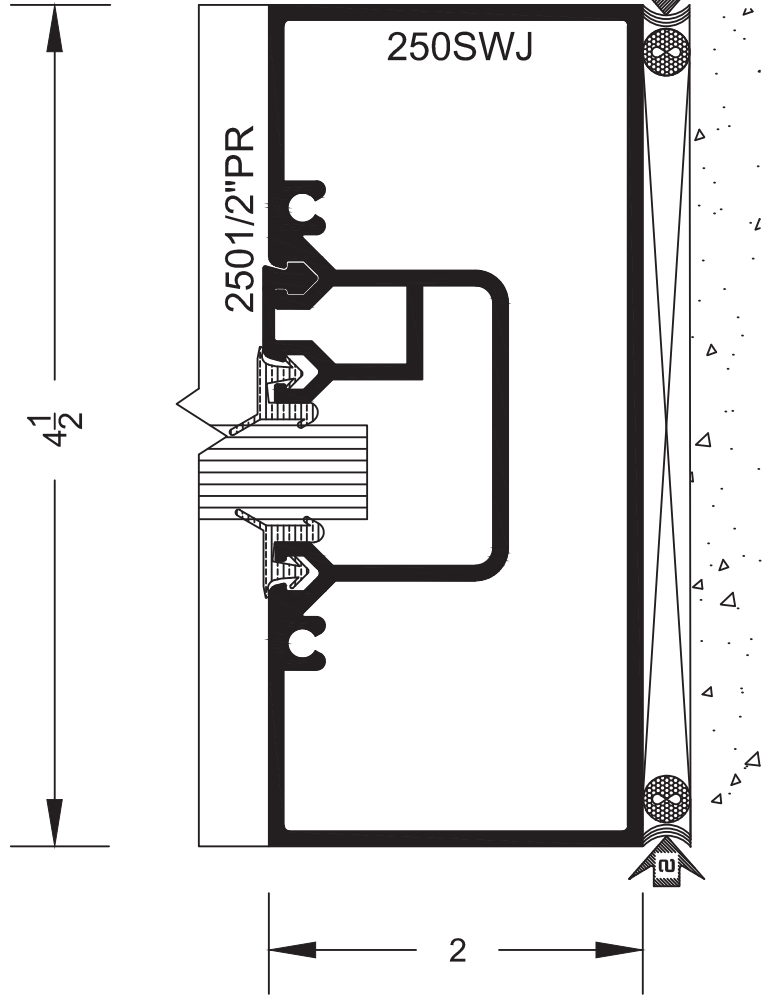
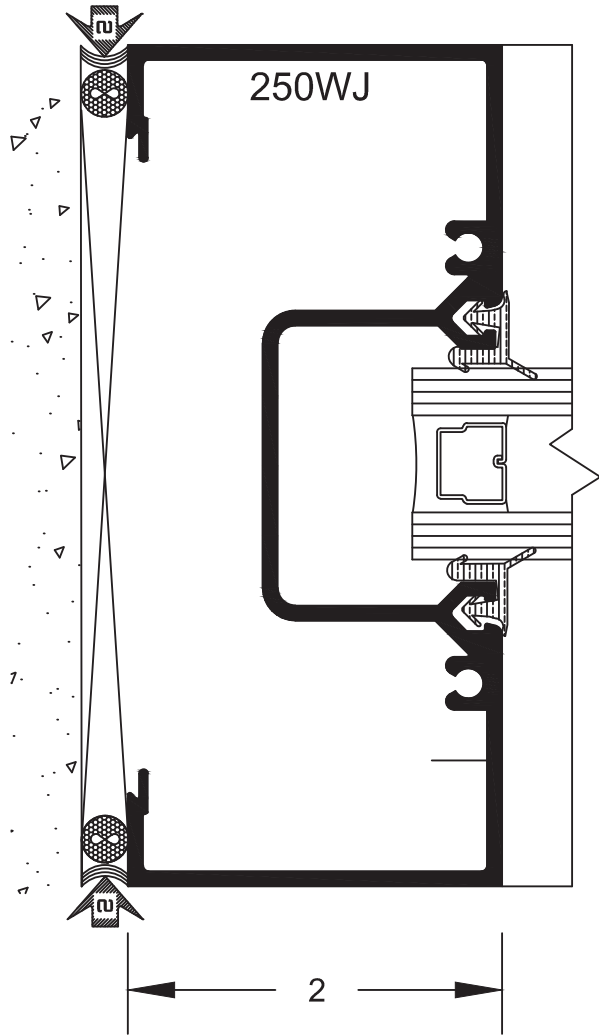

**PL-250 SERIES**  
2" X 4-1/2"  
FULL SCALE

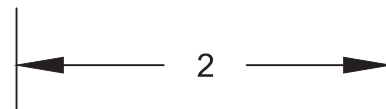
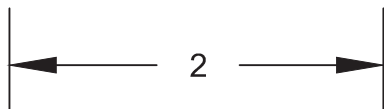
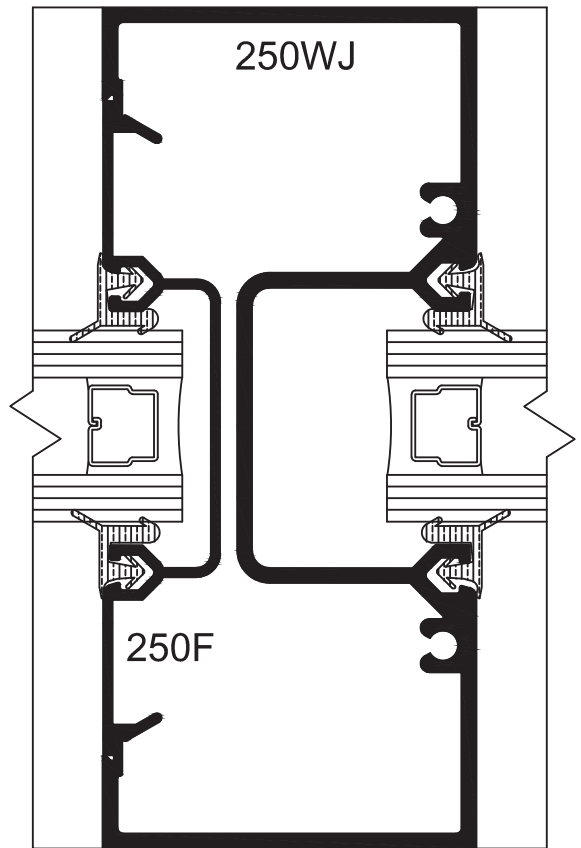
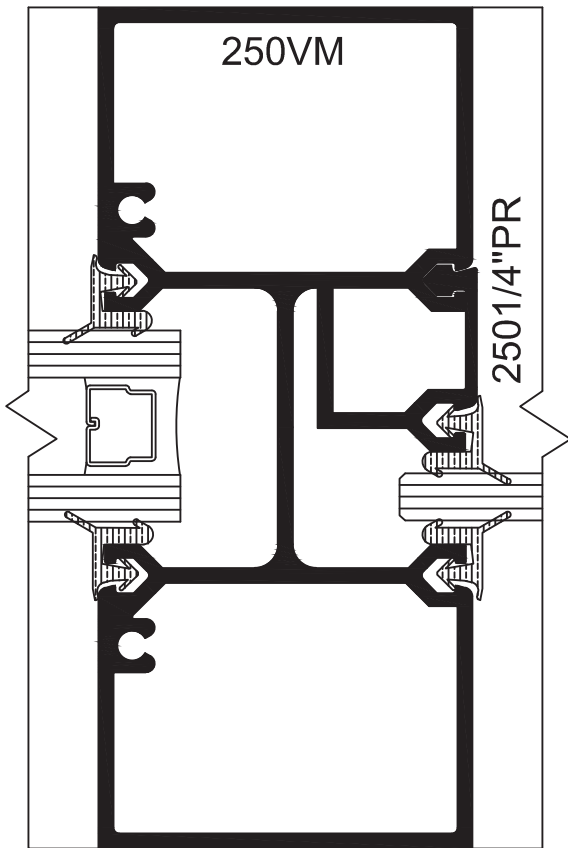

**B-1**

**B-2**

**PL-250 SERIES**  
**2" X 4-1/2"**  
**FULL SCALE**

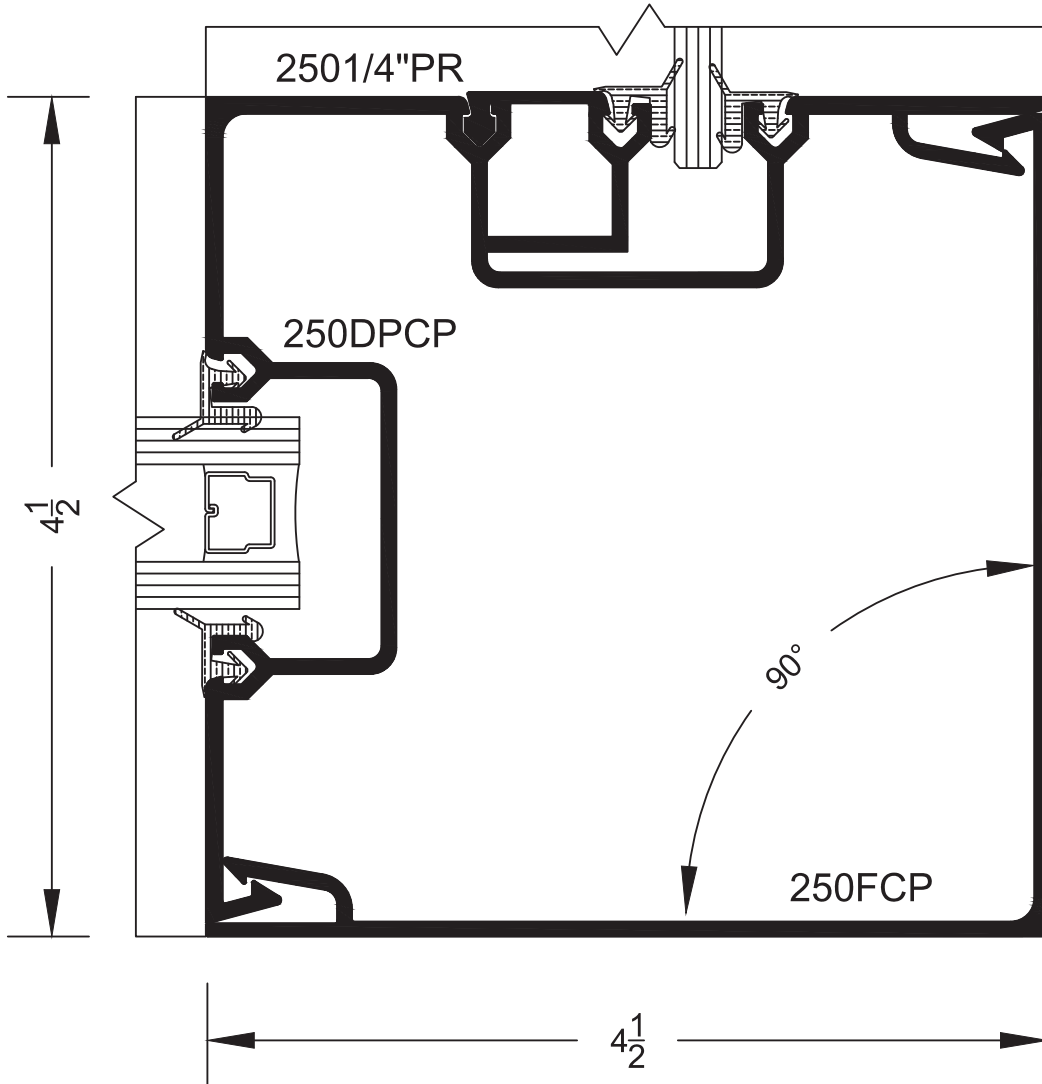

**C-1**

**PL-250 SERIES**  
2" X 4-1/2"  
FULL SCALE

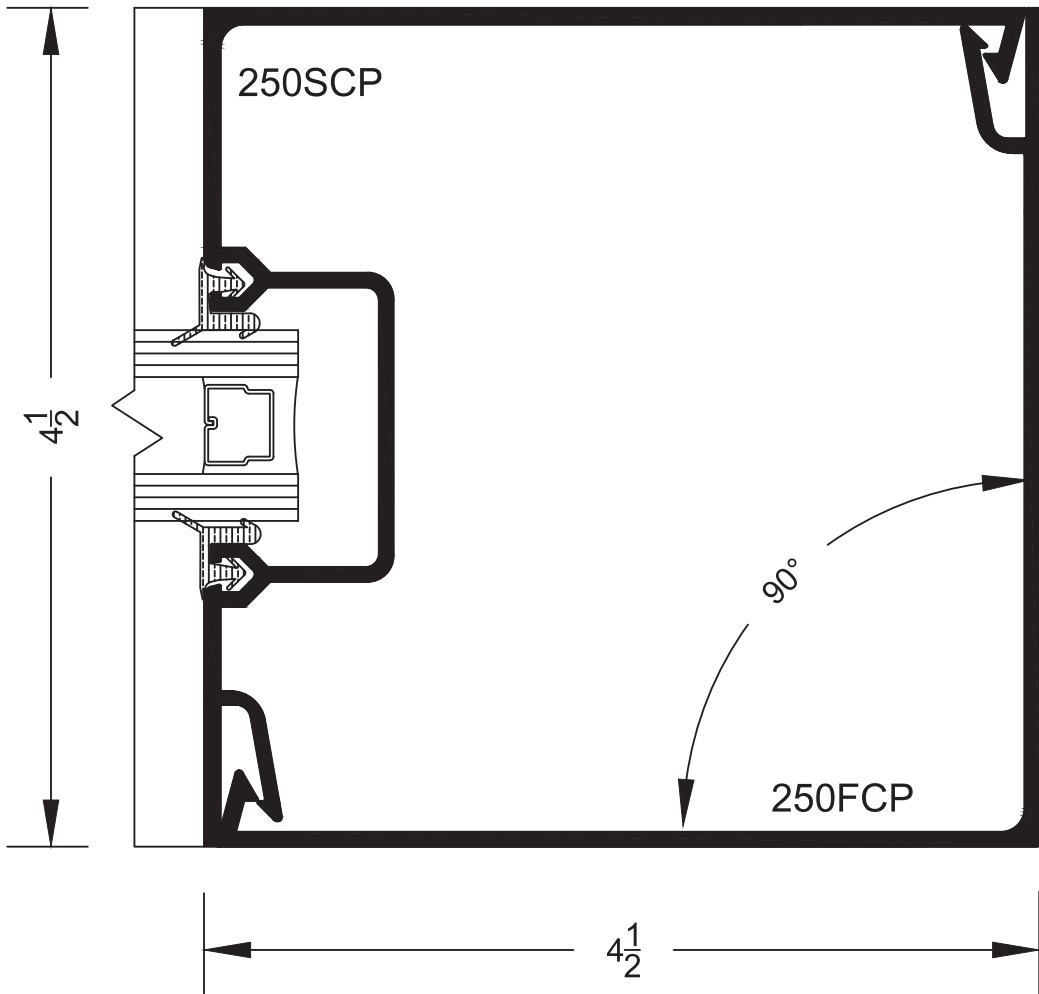

**C-2**

**PL-250 SERIES**  
**2" X 4-1/2"**  
**FULL SCALE**

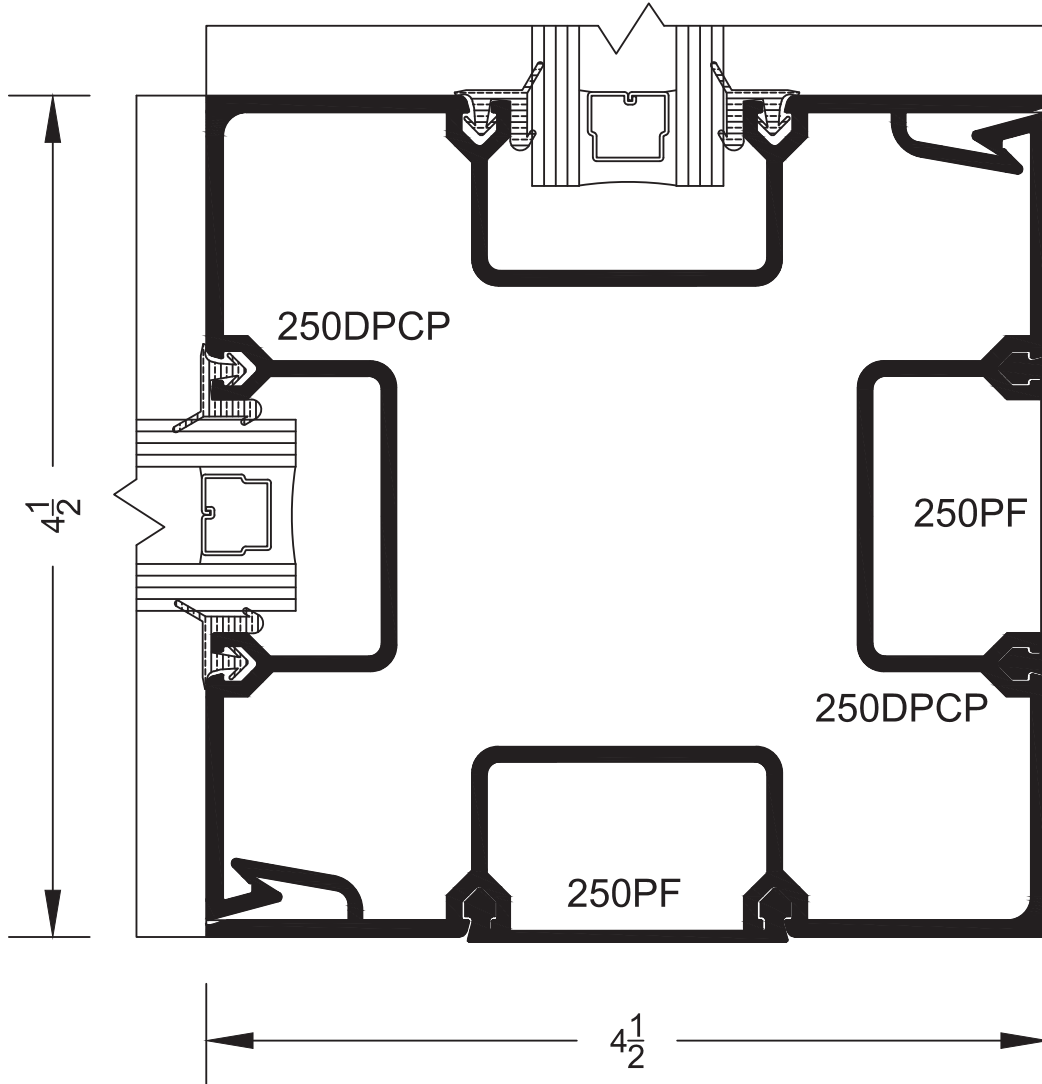

**C-3**

ph: (877) 775-2586  
fx: (877) 274-8800

**PL-250 - 11**  
14760 Don Julian Rd.  
Industry, CA 91746

[www.prlaluminum.com](http://www.prlaluminum.com)  
[sales@prlaluminum.com](mailto:sales@prlaluminum.com)

**PL-250 SERIES**  
**2" X 4-1/2"**  
**FULL SCALE**

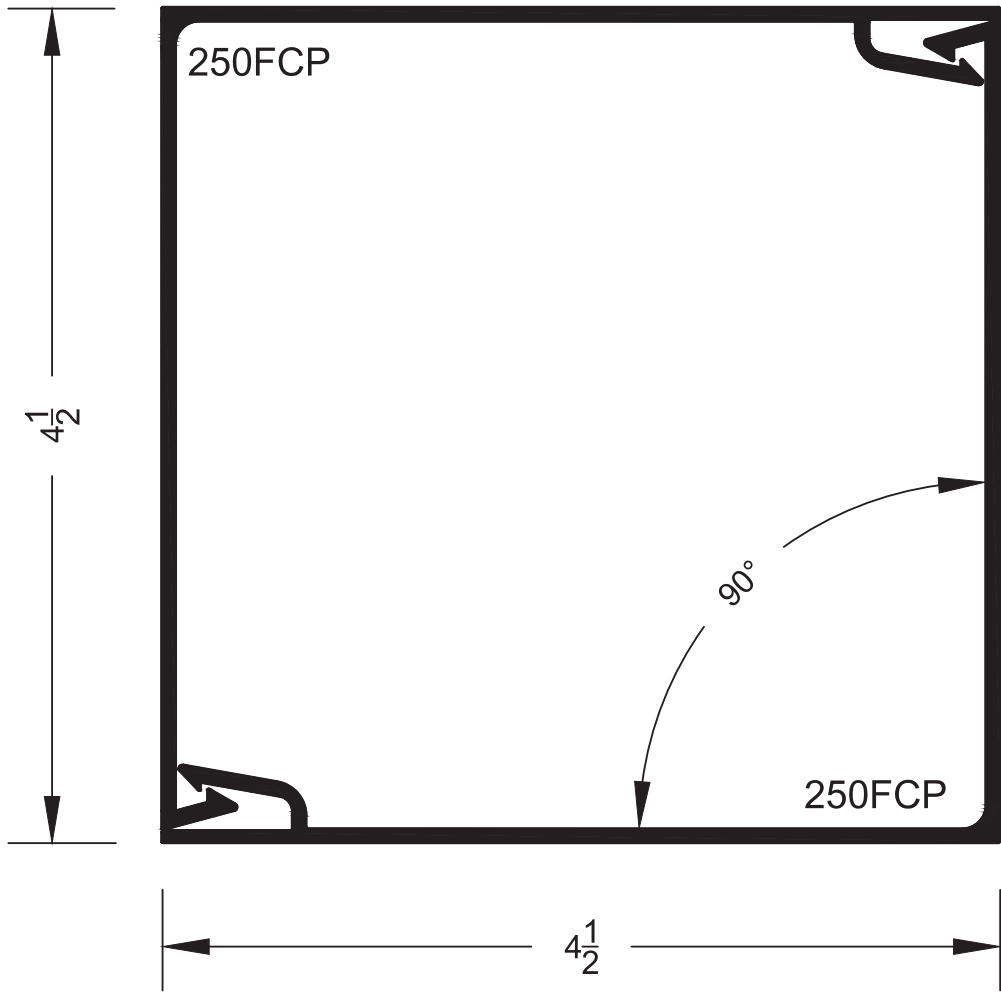

**PL-250 SERIES**  
**2" X 4-1/2"**  
**FULL SCALE**

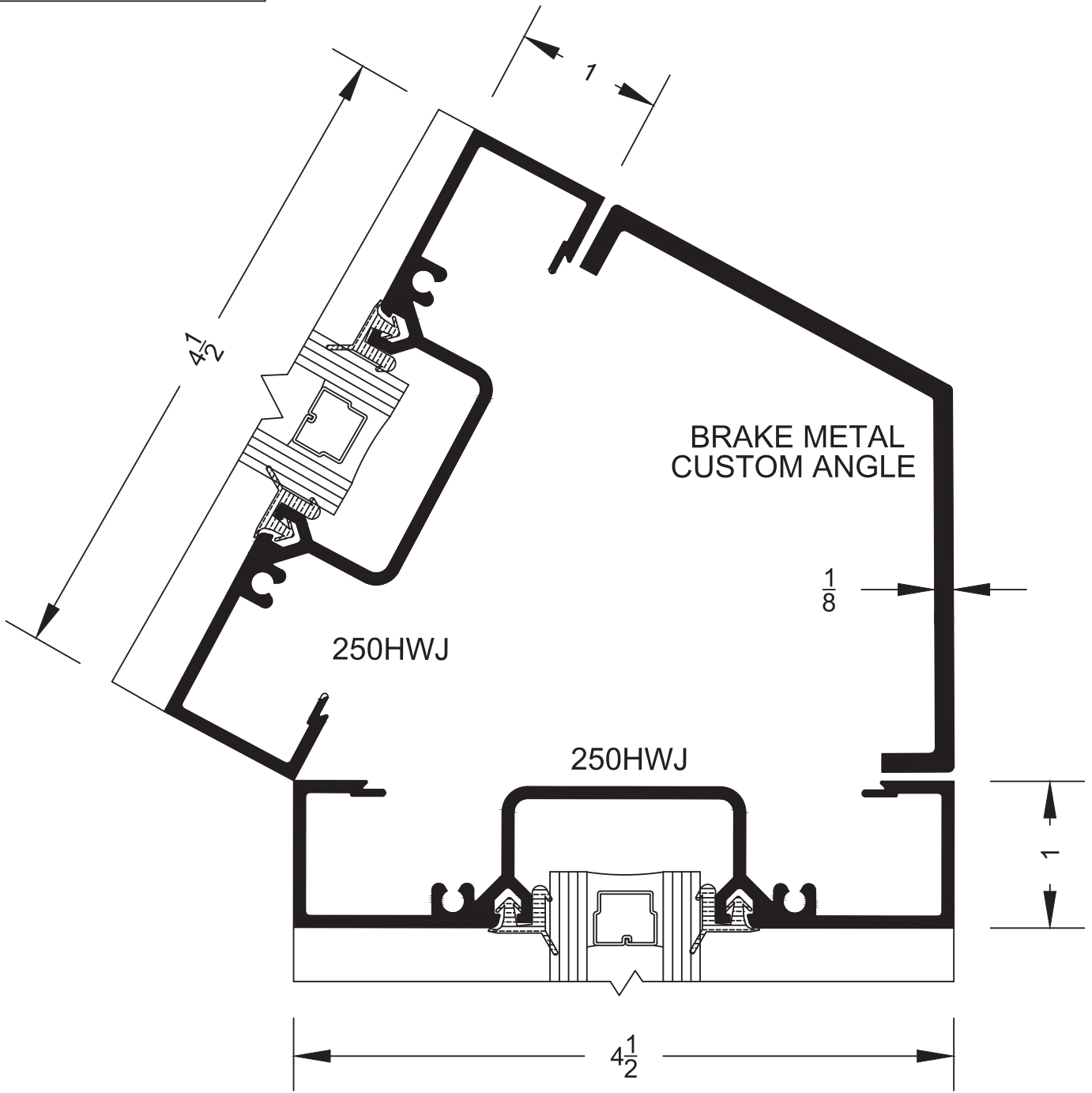



**PL-250 SERIES**  
**2" X 4-1/2"**  
**FULL SCALE**

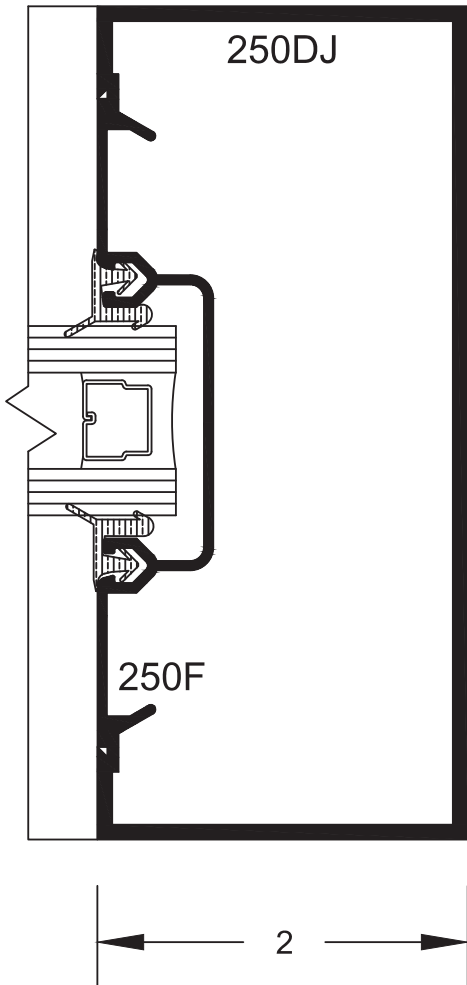

G-1

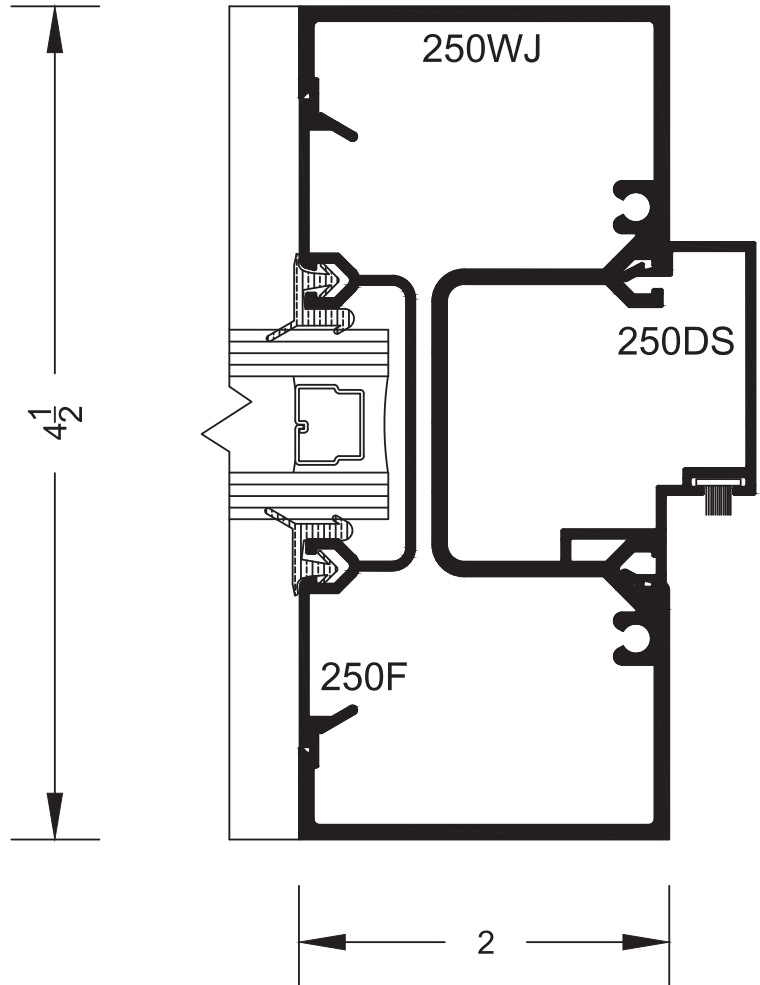

G-2

**PL-250 SERIES**  
2" X 4-1/2"  
FULL SCALE



(K-1)

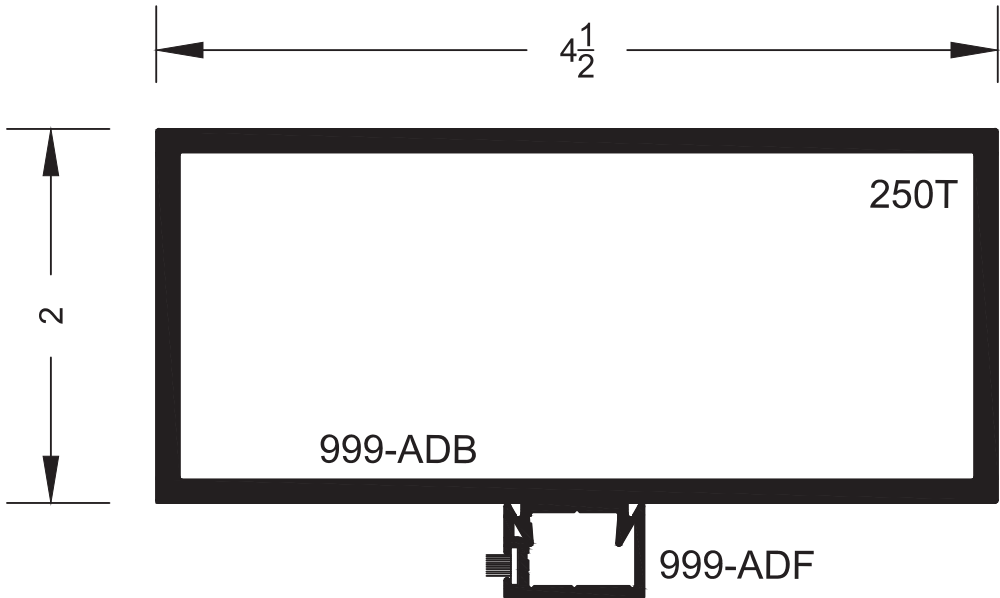

(K-2)

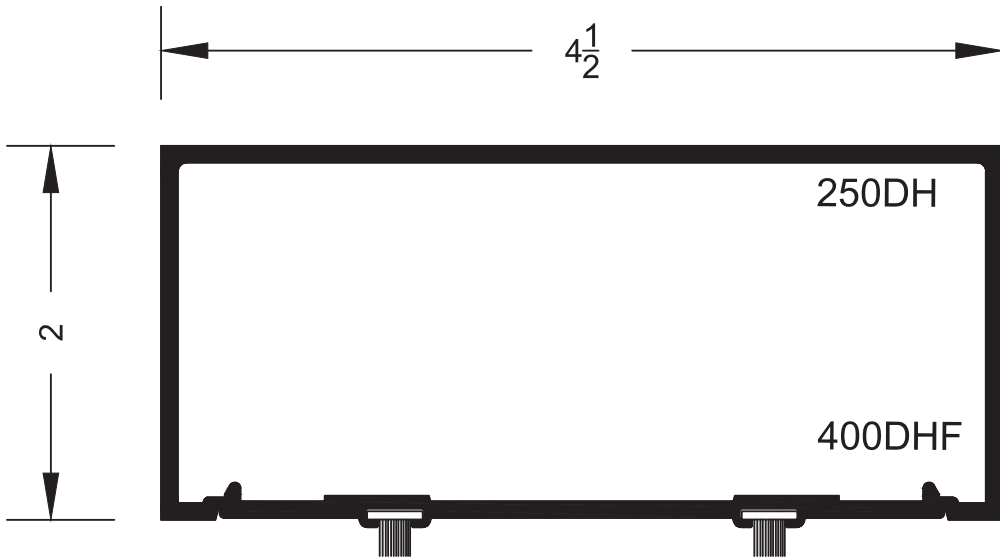

PL-250 SERIES  
2" X 4-1/2"  
FULL SCALE

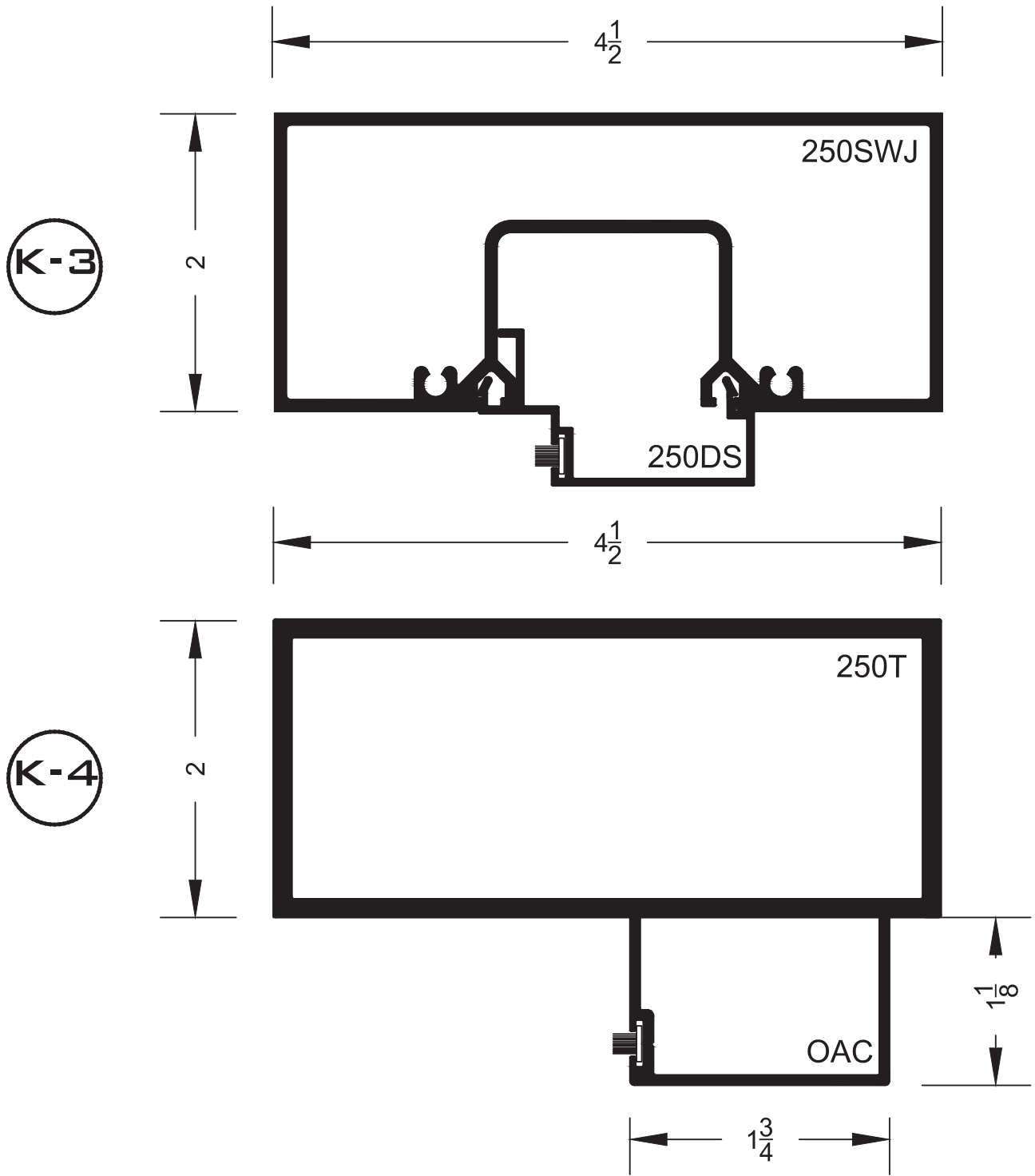

PL-250 - 16

ph: (877) 775-2586  
fx: (877) 274-8800

14760 Don Julian Rd.  
Industry, CA 91746

www.prlaluminum.com  
sales@prlaluminum.com

**PL-250 SERIES**  
**2" X 4-1/2"**  
**FULL SCALE**



1/2" POCKET  
 REDUCER



1/4" POCKET  
 REDUCER



1" VINYL SASH

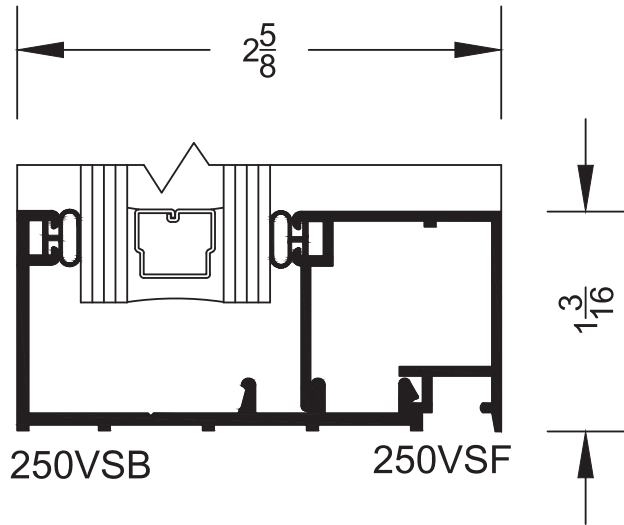



## WIND LOAD DESIGN

GLAZING FRAMING SHALL BE DESIGNED NOT TO EXCEED L/175, RATIO CURVES SHALL REPRESENT LIMIT.

VALUES ARE BASED ON CRITERIA FOR SIMPLE BEAM UNIFORMLY LOADED

ALLOWABLE STRESSES FOR 6063-T5 ALUMINUM ALLOY = 9500 P.S.I.  
ALLOWABLE STRESSES FOR A-36 STRUCTURAL STEEL = 21600 P.S.I.

MAXIMUM DEFLECTION BETWEEN SUPPORTS FOR SINGLE SPAN:

$$\Delta = \frac{5WL^3}{384EI}$$

MAXIMUM BENDING MOMENT FOR SINGLE SPAN:

$$M = \frac{WL}{8}$$

NOTATIONS REPRESENT:

W = TOTAL UNIFORM LOAD

L = LENGTH OF MULLION BETWEEN SUPPORTS

E =  $10 \times 10^6$  P.S.I.

I = MOMENT OF INERTIA OF MULLION

M = BENDING MOMENT

NOTE:

MULLIONS ARE ASSUMED TO HAVE EQUAL SIZE GLASS LIGHTS EACH SIDE

**250 VERTICAL WALL JAMB WITH FILLER**

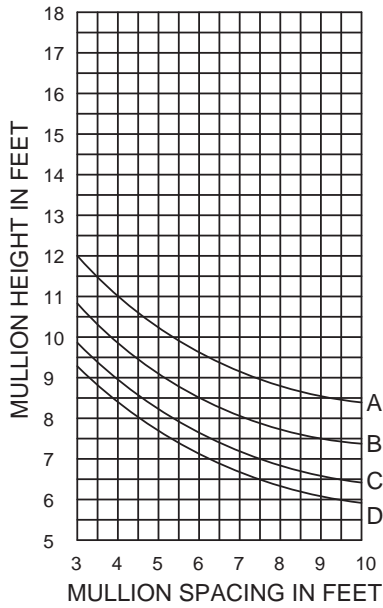

$I_{102} = 1.630 \text{ IN}^4$   
 $S_{102} = 0.815 \text{ IN}^3$



**250 DOOR JAMB W/ FILLER**

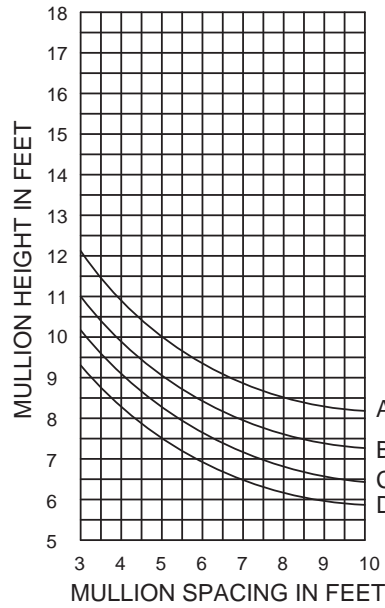

$I = 2.733 \text{ IN}^4$   
 $S = 1.215 \text{ IN}^3$

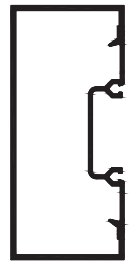

**CURVE REPRESENTATION**  
 A = 15 P.S.F. ( 75 M.P.H )  
 B = 20 P.S.F. ( 90 M.P.H )  
 C = 25 P.S.F. ( 100 M.P.H )  
 D = 30 P.S.F. ( 110 M.P.H )

**250 DOOR JAMB W/ FILLER WITH STEEL REINFORCEMENT**

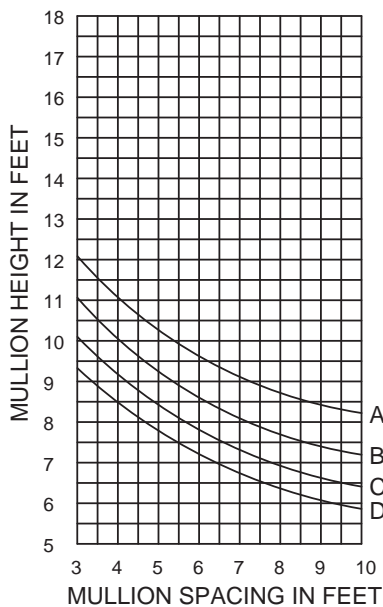

$I = 7.569 \text{ IN}^4$



**250 TUBE**

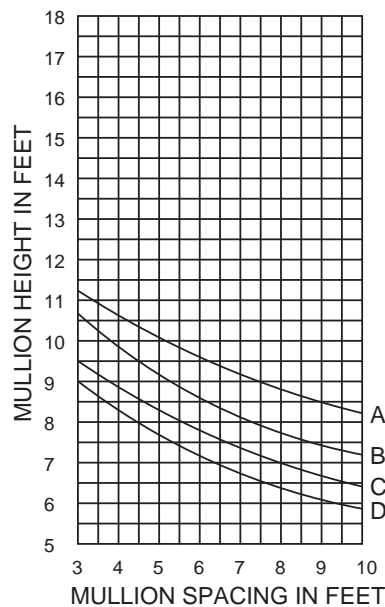

$I = 2.040 \text{ IN}^4$   
 $S = 1.20 \text{ IN}^3$

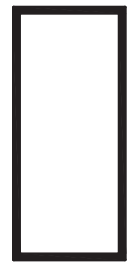

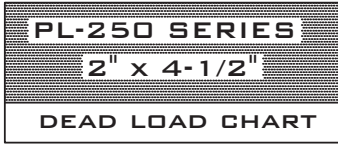

## DEAD LOAD DESIGN

GLAZING FRAMING SHALL BE DESIGNED NOT TO EXCEED L/360 OR 1/8" DEFLECTION WHICHEVER IS LES, RATIO CURVES SHALL REPRESENT LIMIT.

VALUES ARE BASED ON CRITERIA FOR SIMPLE BEAM UNIFORMLY LOADED.

ALLOWABLE STRESSES FOR 6063-T5 ALUMINUM ALLOY = 9500 P.S.I.  
ALLOWABLE STRESSES FOR A-36 STRUCTURAL STEEL = 21600 P.S.I.

MAXIMUM DEFLECTION BETWEEN SUPPORTS FOR SINGLE SPAN:

$$\Delta = \frac{Pa}{24EI} (3L^2 - 4a^2)$$

MAXIMUM BENDING MOMENT FOR SINGLE SPAN:

$$M = Pa$$

NOTATIONS REPRESENT:

P = 1/2 GLASS LOAD

a = 1/4 OR 1/8 POINT OF SPAN (INCHES)

E = 10 X 10<sup>6</sup> P.S.I.

I = MOMENT OF INERTIA OF MULLION

L = LENGTH HORIZONTAL SPAN

**PL-250 SERIES**  
**2" x 4-1/2"**  
**DEAD LOAD CHART**



250 HORIZONTAL MULLION

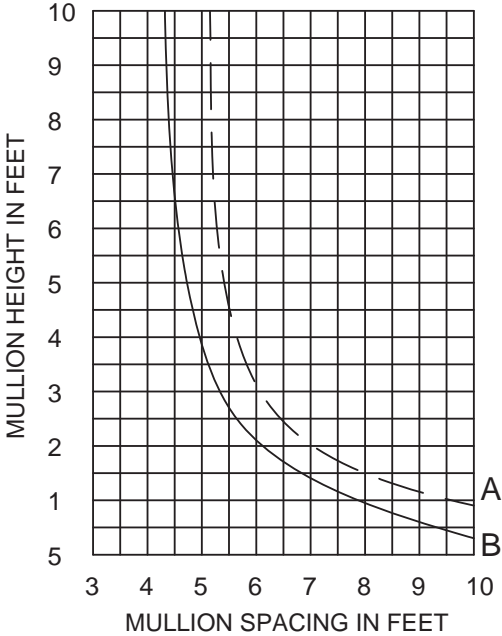

$I = 0.330 \text{ IN}^4$       MAX ALLOW DEFLECTION  $L/360$   
 $S = 0.329 \text{ IN}^3$       OR  $1/8"$  WHICHEVER IS LESS

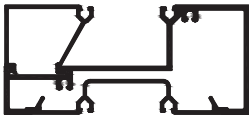

**CURVE REPRESENTATION**  
**(A) ( - - - - ) = 1/8 PTS. OR A MINIMUM OF 8" AWAY FROM THE EDGE OF GLASS**  
**(B) ( ——— ) = 1/4 PTS. A MINIMUM OF 8" AWAY FROM THE EDGE OF GLASS**



**251 SERIES**  
**2" x 4 1/2"**  
**SECTION**

**251 SERIES**

2" x 4 1/2"

SECTION



## ALUMINUM STOREFRONTS PL-251 SERIES

### **PART 1 GENERAL**

#### 1.1 SECTION INCLUDES

- A. Aluminum storefronts.

#### 1.2 REFERENCES

- A. ASTM International (ASTM):
  1. ASTM B 221 - Standard Specification for Aluminum and Aluminum-Alloy Extruded Bars, Rods, Wire, Profiles, and Tubes.
  2. ASTM E 283 - Test Method for Determining the Rate of Air Leakage Through Exterior Windows, Curtain Walls, and Doors under Specified Pressure Differences across the Specimen.
  3. ASTM E 330 - Standard Test Method for Structural Performance of Exterior Windows, Doors, Skylights and Curtain Walls by Uniform Static Air Pressure Difference.
  4. ASTM E 331 - Test Method for Water Penetration of Exterior Windows, Curtain Walls, and Doors by Uniform Static Air Pressure Difference.

#### 1.3 SUBMITTALS

- A. Submit under provisions of applicable Requirements.
- B. Product Data: Manufacturer's data sheets on each product to be used, including:
  1. Preparation instructions and recommendations.
  2. Storage and handling requirements and recommendations.
  3. Installation methods.
- C. Shop Drawings: Configuration and details for installation, maintenance and operation.
- D. Selection Samples: For each finish product specified, two complete sets of color chips representing manufacturer's full range of available colors and patterns.
- E. Verification Samples: For each finish product specified, two samples, minimum size 6 inches (150 mm) square representing actual product, color, and patterns.

#### 1.4 QUALITY ASSURANCE

- A. Manufacturer Qualifications: Minimum 5 year experience manufacturing similar products.
- B. Installer Qualifications: Minimum 2 year experience installing similar products.
- C. Mock-Up: Provide a mock-up for evaluation of surface preparation techniques and application workmanship.
  1. Finish areas designated by Architect.
  2. Do not proceed with remaining work until workmanship is approved by Architect.
  3. Refinish mock-up area as required to produce acceptable work.

#### 1.5 PRE-INSTALLATION MEETINGS

### **PL-251 - 1**

- A. Convene minimum two weeks prior to starting work of this section.

#### 1.6 DELIVERY, STORAGE, AND HANDLING

- A. Deliver and store products in manufacturer's unopened packaging bearing the brand name and manufacturer's identification until ready for installation.
- B. Handling: Handle materials to avoid damage.

#### 1.7 PROJECT CONDITIONS

- A. Maintain environmental conditions (temperature, humidity, and ventilation) within limits recommended by manufacturer for optimum results. Do not install products under environmental conditions outside manufacturer's recommended limits.

#### 1.8 SEQUENCING

- A. Ensure that products of this section are supplied to affected trades in time to prevent interruption of construction progress.

### **PART 2 PRODUCTS**

#### 2.1 MANUFACTURERS

- A. Acceptable Manufacturer: PRL Glass Systems, Inc., which is located at: 13644 Nelson Ave.; City of Industry, CA 91746; Toll Free Tel: 800-433-7044; Fax: 626-968-9256; Email: request; Web:[prlglass.com](http://prlglass.com)
- B. Substitutions: Not permitted.
- C. Requests for substitutions will be considered in accordance with provisions of Section 01 60 00 - Product Requirements.

#### 2.2 ALUMINUM STOREFRONT

- A. Product: Aluminum Storefront Series as manufactured by PRL Glass Systems, Inc.
- B. Design:
  - 1. Framing sections shall be extruded from 6063-T5 aluminum alloy.
  - 2. Glazing beads shall be NS (non-stretch, high-shore) vinyl used on both sides of the glass. Vinyl shall incorporate a fiberglass cord bonded with the vinyl.
  - 3. Sections shall conform to details and shall present clean, straight, sharply defined lines, and shall be free from defects impairing strength or durability.
  - 4. Screws, nuts, bolts and fastening devices and internal components shall be of aluminum, stainless steel or other non-corrosive material.
  - 5. Factory preparation from detail drawings shall be so fabricated that field assembly will be able to produce accurate, tightly fitted joints.
- C. **251-Series (2 X 4-1/2 Offset Glaze for 1 Glazing) :**
  - 1. Performance: (Test sample of 10 feet (3048 mm) wide by 10 feet (3048 mm) high - 3 lites wide by 2 lites high).
    - a. Air infiltration: Limit air leakage through fixed glazing and frames to 0.039 cfm/ft<sup>2</sup>/min when tested in accordance with ASTM E-283 at a cross pressure of 6.24 psf (0.30 kPa).
    - b. Water Penetration under Static Pressure: System shall not evidence uncontrolled water penetration at a cross pressure of 6 psf (0.29 kPa) when tested in accordance with ASTM-E331-00.
    - c. Uniform Load Structural per ASTM E 330: Limit deflection to L/175.

### **PL-251 - 2**

- 1) Passed at Design Pressure of 20 psf (0.96 kPa).

## **PART 3 EXECUTION**

### 3.1 EXAMINATION

- A. Do not begin installation until substrates have been properly prepared.
- B. If substrate preparation is the responsibility of another installer, notify Architect of unsatisfactory preparation before proceeding.

### 3.2 PREPARATION

- A. Clean surfaces thoroughly prior to installation.
- B. Prepare surfaces using the methods recommended by the manufacturer for achieving the best result for the substrate under the project conditions.

### 3.3 INSTALLATION

- A. Install in accordance with manufacturer's instructions.

### 3.4 FIELD QUALITY CONTROL

- A. All joints between metal and masonry shall be fully caulked and field tested to resist water leakage with provisions taken to drain infiltrated water.

### 3.5 PROTECTION

- A. Protect installed products until completion of project.
- B. Touch-up, repair or replace damaged products before Substantial Completion.

END OF SECTION



**PL-251 SERIES**  
**2" X 4-1/2"**  
**FULL SCALE**



**SCREW RACE**

**QUICK SET**

**SCREW RACE**

**QUICK SET**

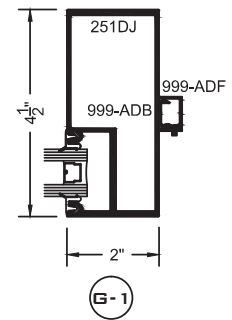
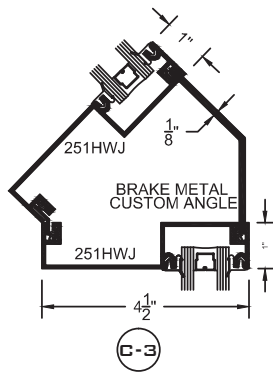
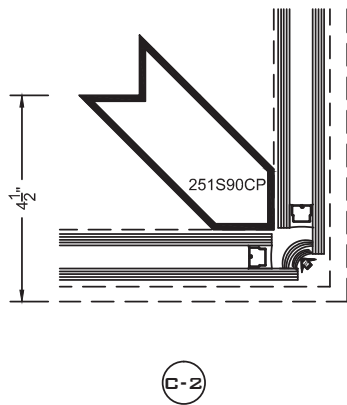
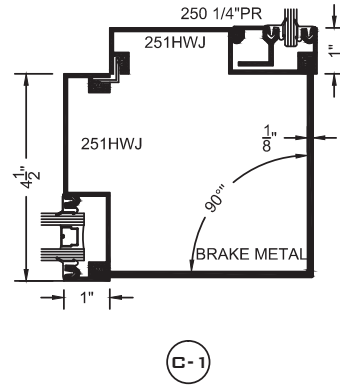
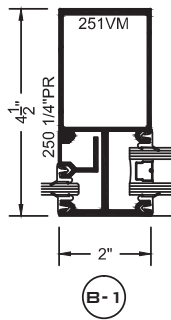
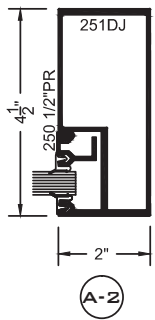
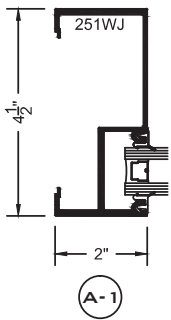
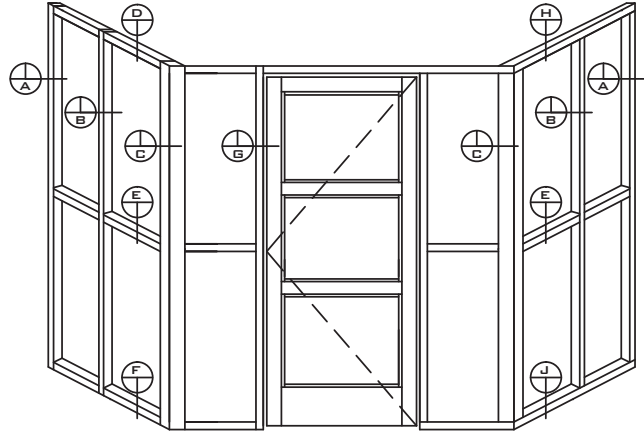
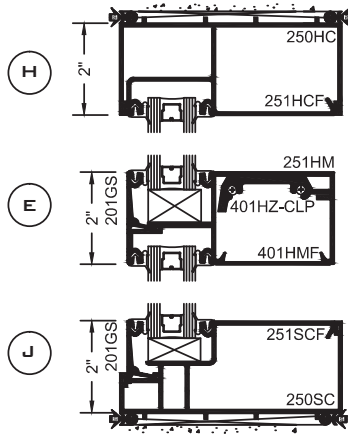
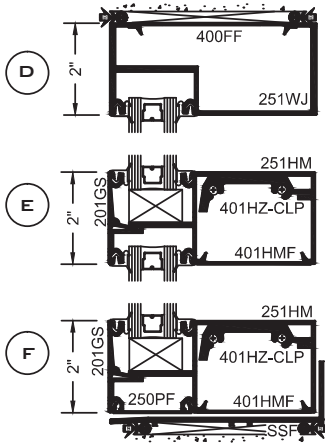

**PL-251 - 4**

ph: (877) 775-2586  
 fx: (877) 274-8800

14760 Don Julian Rd.  
 Industry, CA 91746

www.prlaluminum.com  
 sales@prlaluminum.com

PL-251 SERIES  
 2" X 4-1/2"  
 FULL SCALE

QUICK SET



H

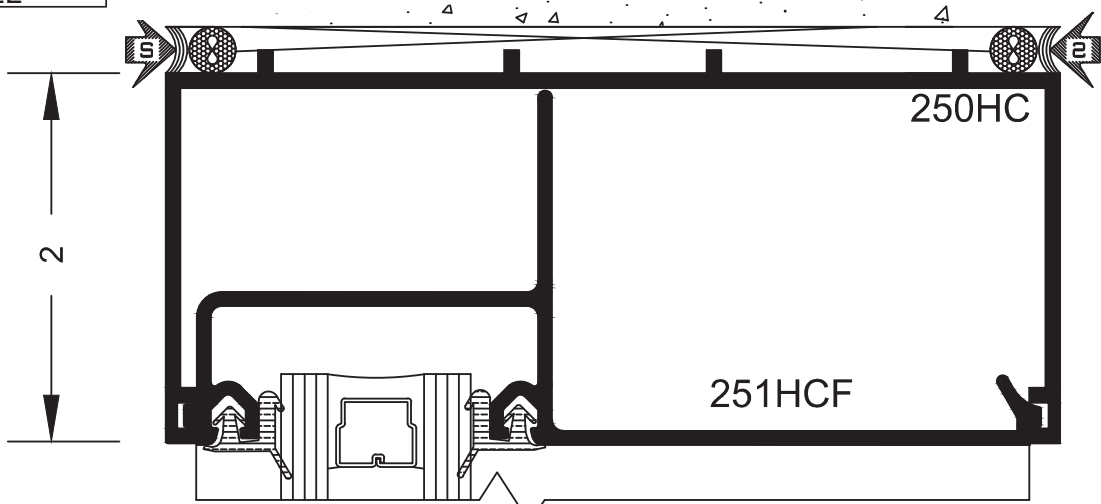

F

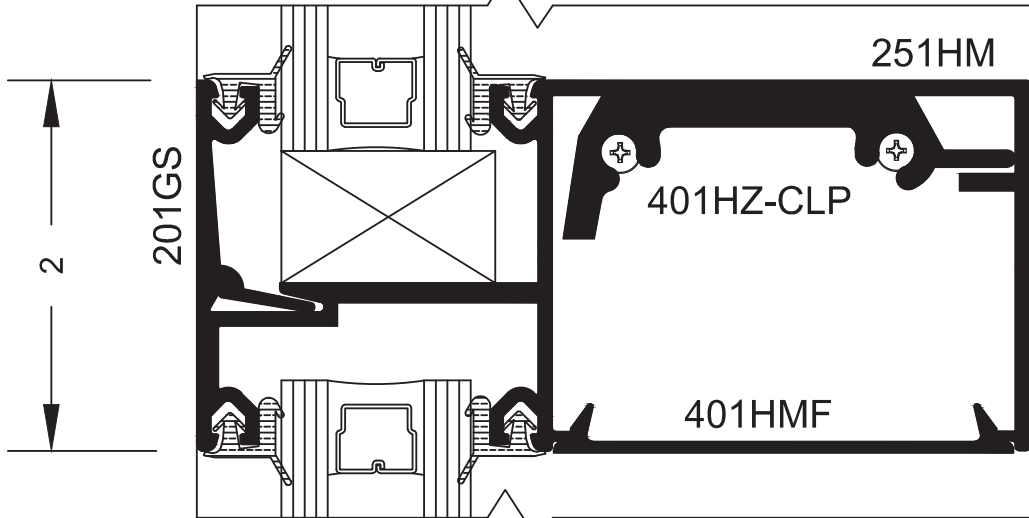

C

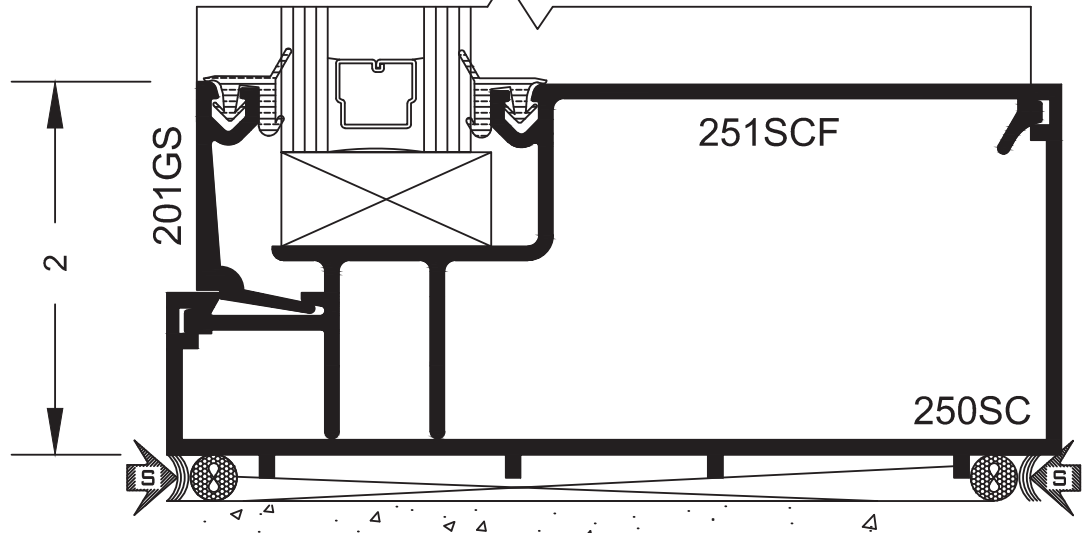

PL-251 - 5

ph: (877) 775-2586  
 fx: (877) 274-8800

14760 Don Julian Rd.  
 Industry, CA 91746

www.prlaluminum.com  
 sales@prlaluminum.com



**PL-251 SERIES**  
**2" X 4-1/2"**  
**FULL SCALE**

**SCREW RACE** 

**D**

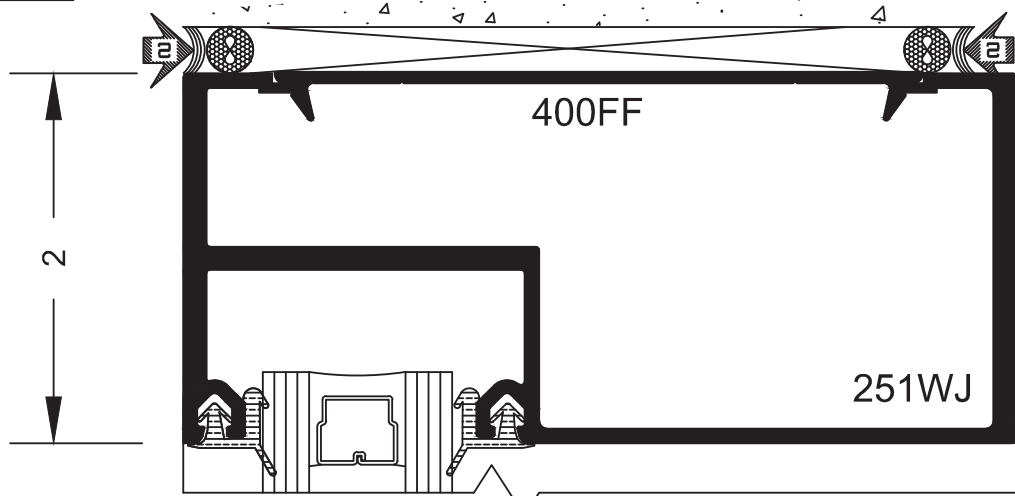

**E**

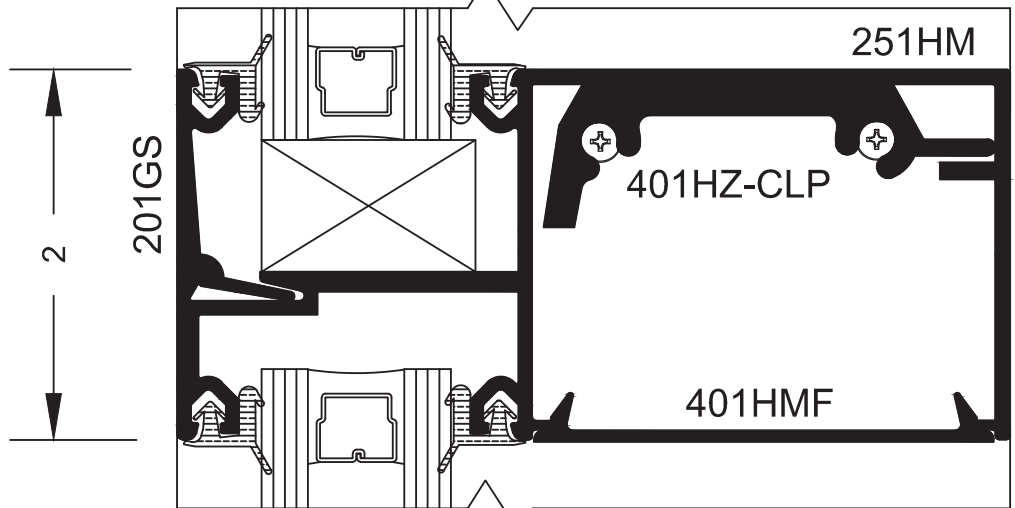

**F**

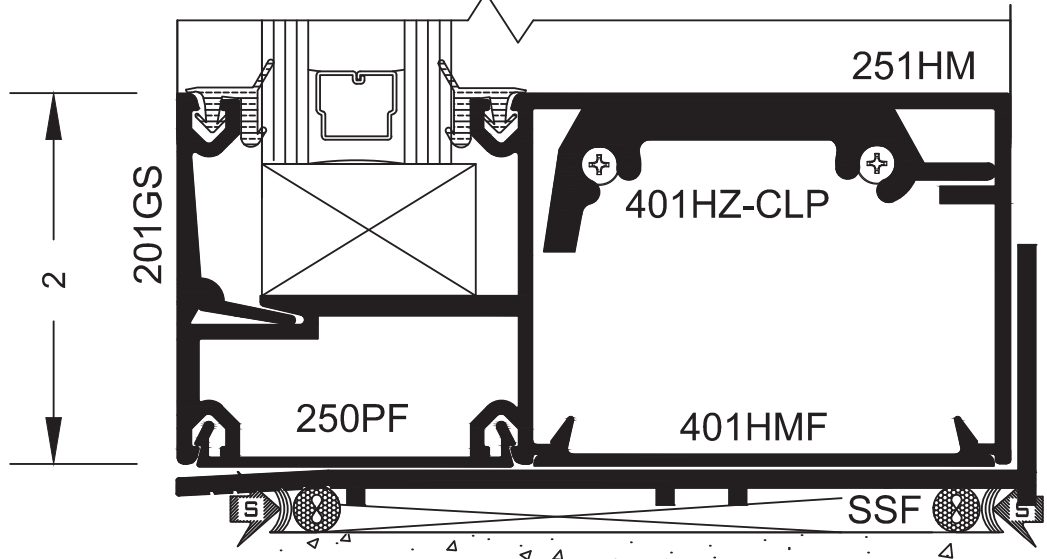

**PL-251 - 6**

ph: (877) 775-2586  
 fx: (877) 274-8800

14760 Don Julian Rd.  
 Industry, CA 91746

www.prlaluminum.com  
 sales@prlaluminum.com

PL-251 SERIES  
2" X 4-1/2"  
FULL SCALE

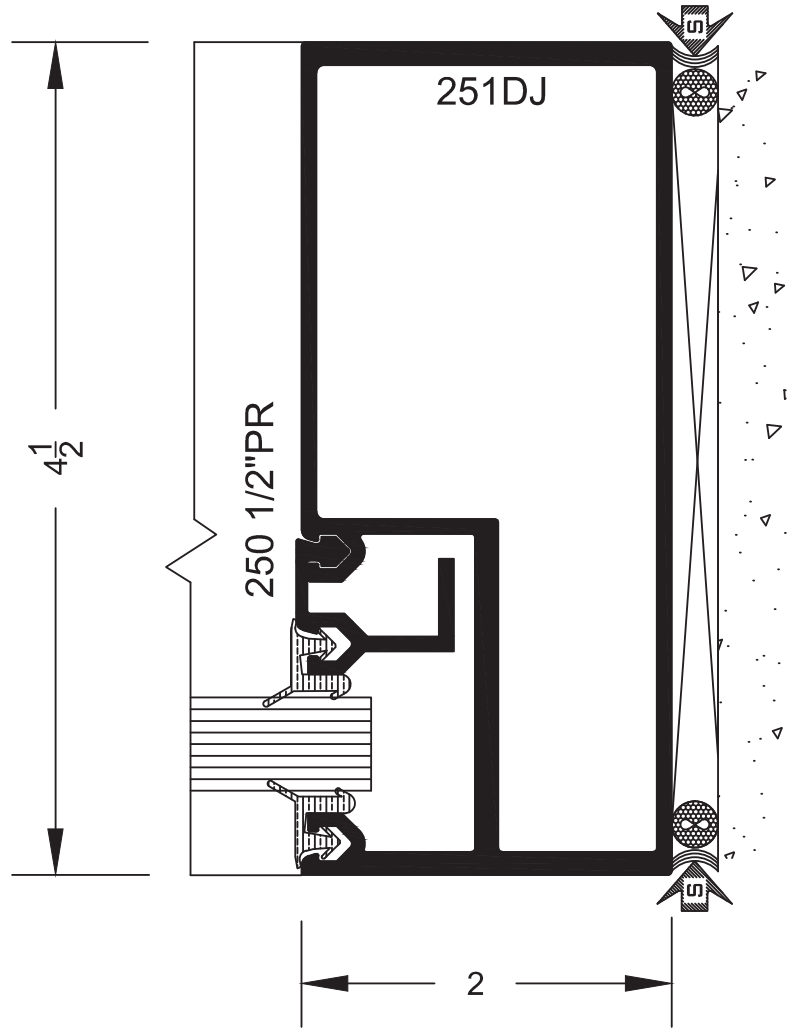
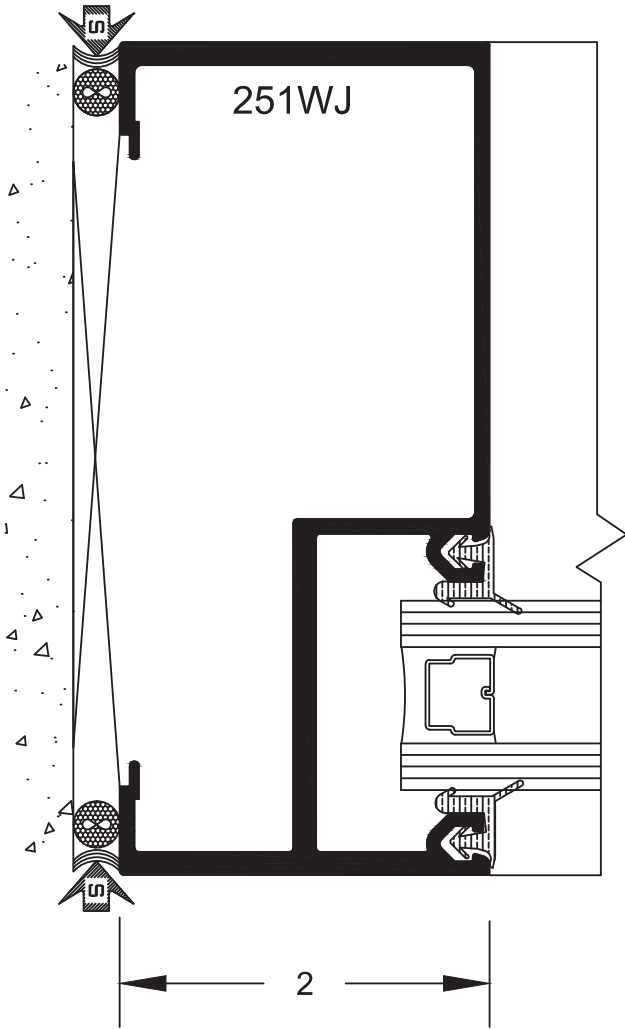

PL-251 SERIES  
2" X 4-1/2"  
FULL SCALE

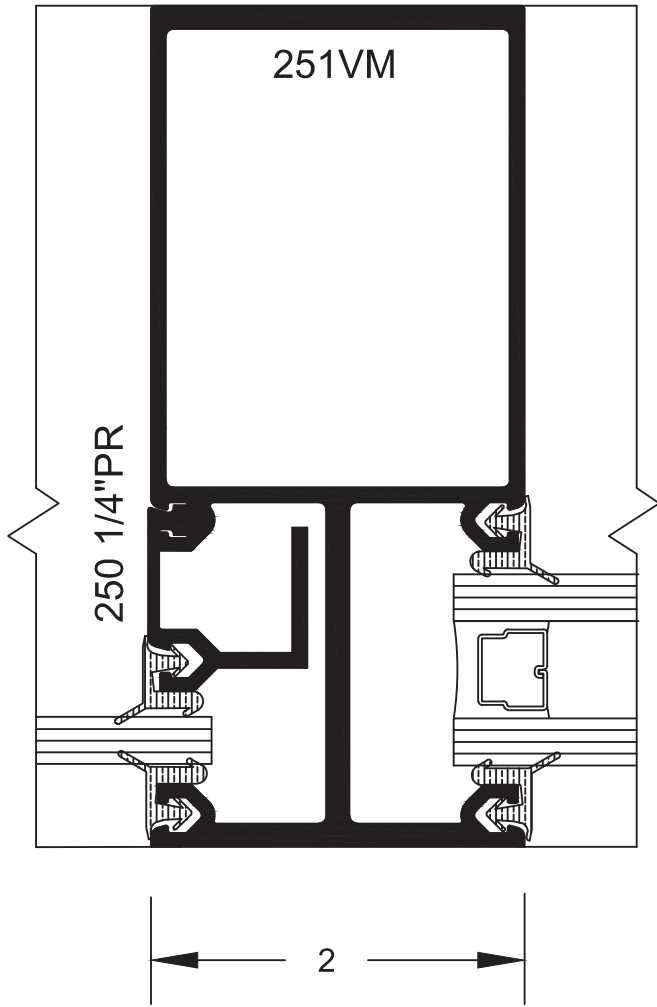

B-1

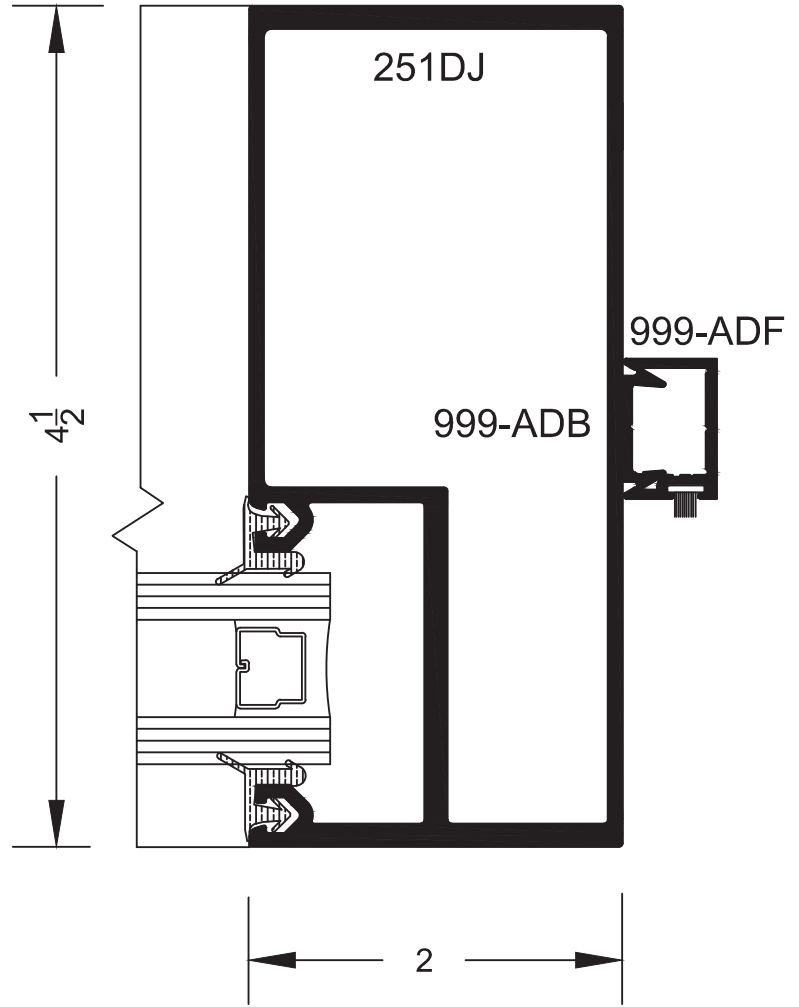

G-1

PL-251 SERIES  
2" X 4-1/2"  
FULL SCALE

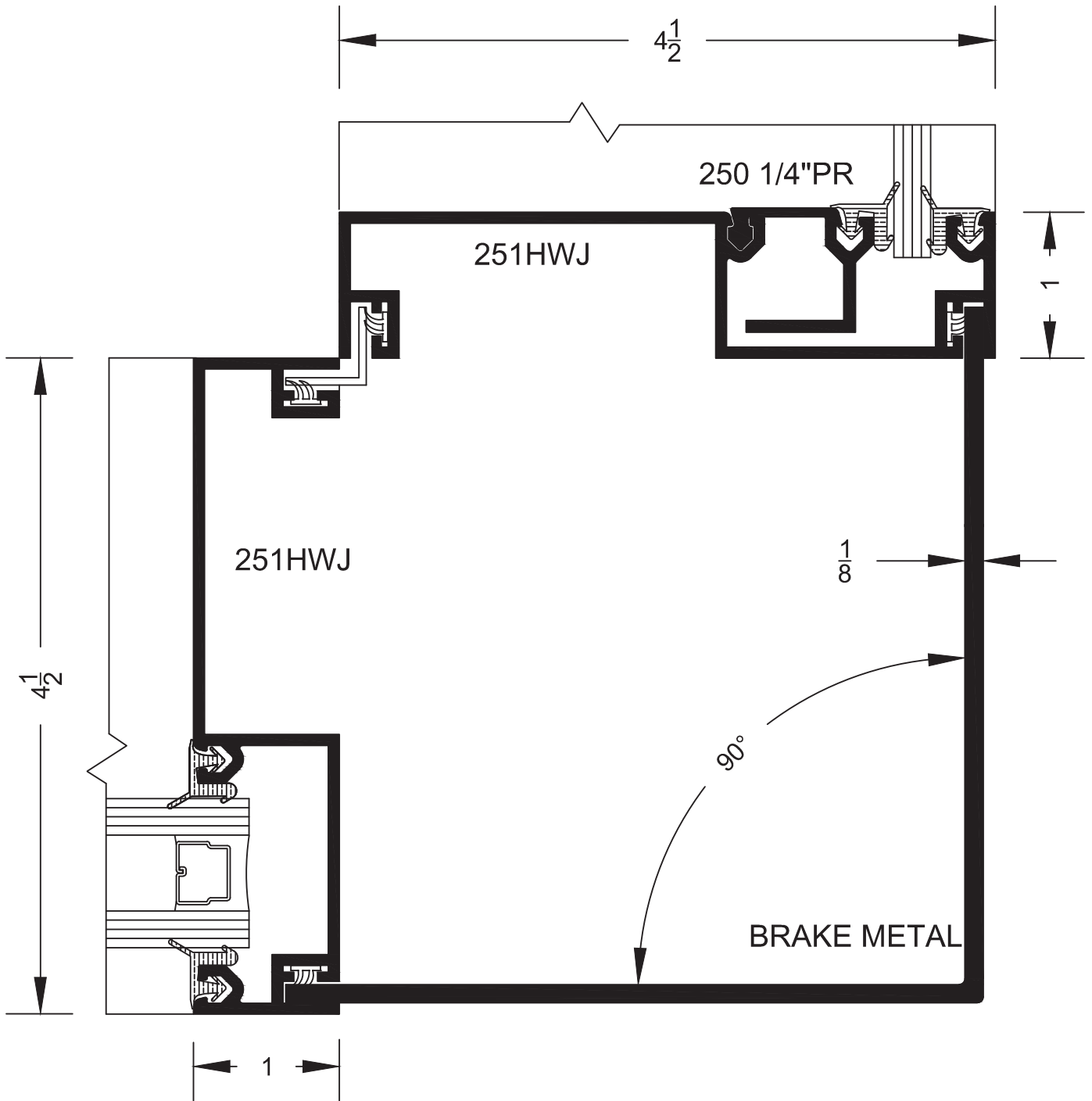

C-1

ph: (877) 775-2586  
fx: (877) 274-8800

PL-251 - 9  
14760 Don Julian Rd.  
Industry, CA 91746

www.prlaluminum.com  
sales@prlaluminum.com

**PL-251 SERIES**  
**2" X 4-1/2"**  
**FULL SCALE**

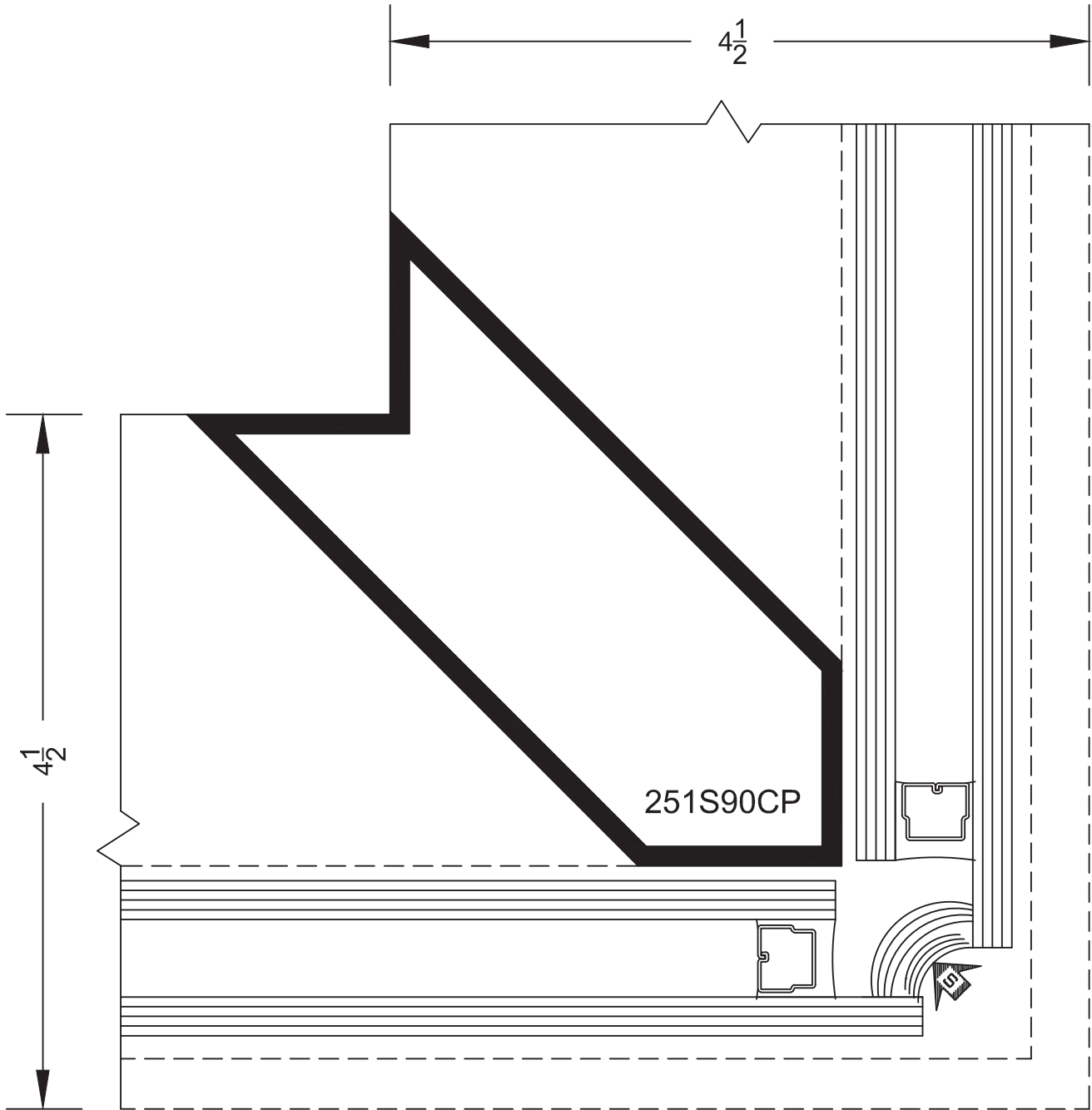

**C-2**

PL-251 SERIES  
2" X 4-1/2"  
FULL SCALE

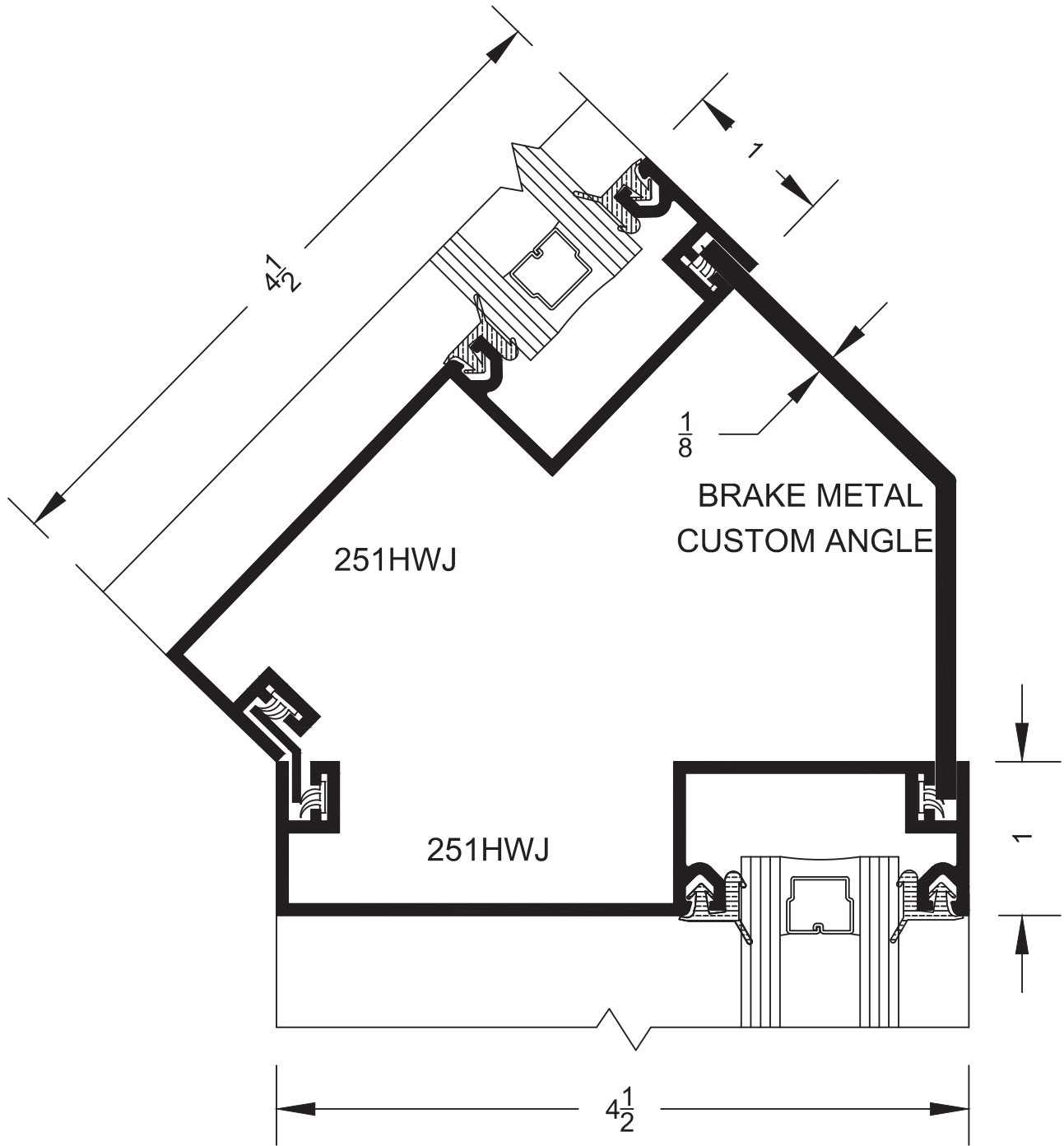

C-3

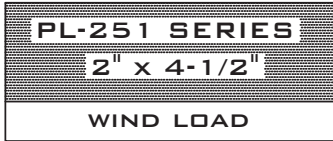

## WIND LOAD DESIGN

GLAZING FRAMING SHALL BE DESIGNED NOT TO EXCEED L/175, RATIO CURVES SHALL REPRESENT LIMIT.

VALUES ARE BASED ON CRITERIA FOR SIMPLE BEAM UNIFORMLY LOADED.

ALLOWABLE STRESSES FOR 6063-T5 ALUMINUM ALLOY = 9500 P.S.I.  
ALLOWABLE STRESSES FOR A-36 STRUCTURAL STEEL = 21600 P.S.I.

MAXIMUM DEFLECTION BETWEEN SUPPORTS FOR SINGLE SPAN:

$$\Delta = \frac{5WL^3}{384EI}$$

MAXIMUM BENDING MOMENT FOR SINGLE SPAN:

$$M = \frac{WL}{8}$$

NOTATIONS REPRESENT:

W = TOTAL UNIFORM LOAD

L = LENGTH OF MULLION BETWEEN SUPPORTS

E =  $10 \times 10^6$  P.S.I.

I = MOMENT OF INERTIA OF MULLION

M = BENDING MOMENT

NOTE:

MULLIONS ARE ASSUMED TO HAVE EQUAL SIZE GLASS LIGHTS EACH SIDE

**251 SOLID WALL JAMB**

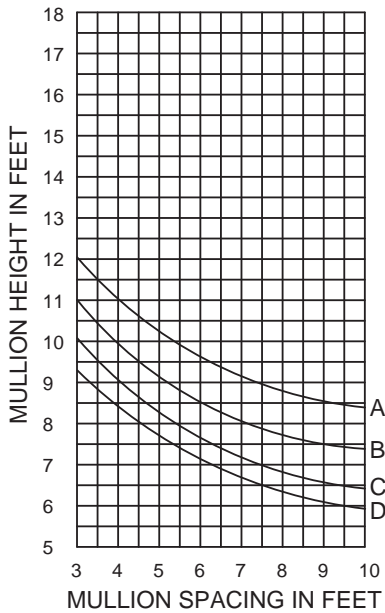

$I = 2.671 \text{ IN}^4$   
 $S = 1.229 \text{ IN}^3$

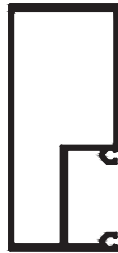

**251 SOLID WALL JAMB WITH STEEL REINFORCEMENT**

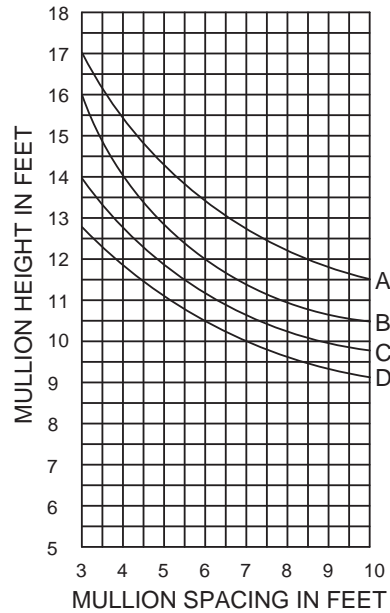

$I = 5.941 \text{ IN}^4$   
 $S = 2.617 \text{ IN}^3$

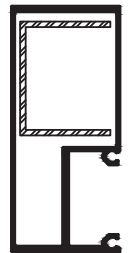

**CURVE REPRESENTATION**

- A = 15 P.S.F. ( 75 M.P.H )
- B = 20 P.S.F. ( 90 M.P.H )
- C = 25 P.S.F. ( 100 M.P.H )
- D = 30 P.S.F. ( 110 M.P.H )

**251 VERTICAL MULLION**

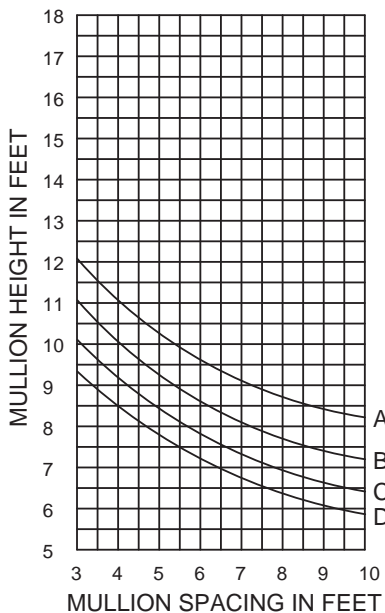

$I = 2.671 \text{ IN}^4$   
 $S = 1.229 \text{ IN}^3$

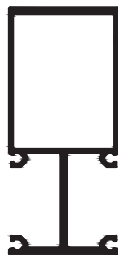

**251 VERTICAL WALL JAMB**

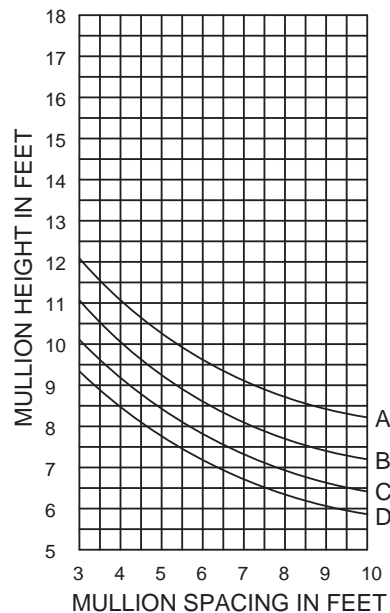

$I = 2.671 \text{ IN}^4$   
 $S = 1.229 \text{ IN}^3$

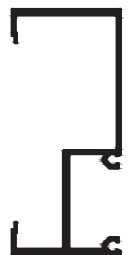



**400 SERIES**

1 3/4" x 4"

SECTION

**400 SERIES**

1 3/4" x 4"

SECTION



## ALUMINUM STOREFRONTS PL-400 SERIES

### **PART 1 GENERAL**

#### 1.1 SECTION INCLUDES

- A. Aluminum storefronts.

#### 1.2 REFERENCES

- A. ASTM International (ASTM):
  1. ASTM B 221 - Standard Specification for Aluminum and Aluminum-Alloy Extruded Bars, Rods, Wire, Profiles, and Tubes.
  2. ASTM E 283 - Test Method for Determining the Rate of Air Leakage Through Exterior Windows, Curtain Walls, and Doors under Specified Pressure Differences across the Specimen.
  3. ASTM E 330 - Standard Test Method for Structural Performance of Exterior Windows, Doors, Skylights and Curtain Walls by Uniform Static Air Pressure Difference.
  4. ASTM E 331 - Test Method for Water Penetration of Exterior Windows, Curtain Walls, and Doors by Uniform Static Air Pressure Difference.

#### 1.3 SUBMITTALS

- A. Submit under provisions of applicable Requirements.
- B. Product Data: Manufacturer's data sheets on each product to be used, including:
  1. Preparation instructions and recommendations.
  2. Storage and handling requirements and recommendations.
  3. Installation methods.
- C. Shop Drawings: Configuration and details for installation, maintenance and operation.
- D. Selection Samples: For each finish product specified, two complete sets of color chips representing manufacturer's full range of available colors and patterns.
- E. Verification Samples: For each finish product specified, two samples, minimum size 6 inches (150 mm) square representing actual product, color, and patterns.

#### 1.4 QUALITY ASSURANCE

- A. Manufacturer Qualifications: Minimum 5 year experience manufacturing similar products.
- B. Installer Qualifications: Minimum 2 year experience installing similar products.
- C. Mock-Up: Provide a mock-up for evaluation of surface preparation techniques and application workmanship.
  1. Finish areas designated by Architect.
  2. Do not proceed with remaining work until workmanship is approved by Architect.
  3. Refinish mock-up area as required to produce acceptable work.

#### 1.5 PRE-INSTALLATION MEETINGS

### **PL-400 - 1**

- A. Convene minimum two weeks prior to starting work of this section.

#### 1.6 DELIVERY, STORAGE, AND HANDLING

- A. Deliver and store products in manufacturer's unopened packaging bearing the brand name and manufacturer's identification until ready for installation.
- B. Handling: Handle materials to avoid damage.

#### 1.7 PROJECT CONDITIONS

- A. Maintain environmental conditions (temperature, humidity, and ventilation) within limits recommended by manufacturer for optimum results. Do not install products under environmental conditions outside manufacturer's recommended limits.

#### 1.8 SEQUENCING

- A. Ensure that products of this section are supplied to affected trades in time to prevent interruption of construction progress.

### **PART 2 PRODUCTS**

#### 2.1 MANUFACTURERS

- A. Acceptable Manufacturer: PRL Glass Systems, Inc., which is located at: 13644 Nelson Ave.; City of Industry, CA 91746; Toll Free Tel: 800-433-7044; Fax: 626-968-9256; Email: request; Web:[prlglass.com](http://prlglass.com)
- B. Substitutions: Not permitted.
- C. Requests for substitutions will be considered in accordance with provisions of Section 01 60 00 - Product Requirements.

#### 2.2 ALUMINUM STOREFRONT

- A. Product: Aluminum Storefront Series as manufactured by PRL Glass Systems, Inc.
- B. Design:
  - 1. Framing sections shall be extruded from 6063-T5 aluminum alloy.
  - 2. Glazing beads shall be NS (non-stretch, high-shore) vinyl used on both sides of the glass. Vinyl shall incorporate a fiberglass cord bonded with the vinyl.
  - 3. Sections shall conform to details and shall present clean, straight, sharply defined lines, and shall be free from defects impairing strength or durability.
  - 4. Screws, nuts, bolts and fastening devices and internal components shall be of aluminum, stainless steel or other non-corrosive material.
  - 5. Factory preparation from detail drawings shall be so fabricated that field assembly will be able to produce accurate, tightly fitted joints.
- C. **400-Series (1-3/4 X 4 Center Glaze For 1/4 Glazing):**
  - 1. Performance: (Test sample of 10 feet (3048 mm) wide by 10 feet (3048 mm) high - 3 lites wide by 2 lites high).
    - a. Air infiltration: Limit air leakage through fixed glazing and frames to 0.041 cfm/ft<sup>2</sup>/min when tested in accordance with ASTM E-283 at a cross pressure of 6.24 psf (0.30 kPa)
    - b. Water Penetration under Static Pressure: System shall not evidence uncontrolled water penetration at a cross pressure of 6 psf (0.29 kPa) when tested in accordance with ASTM-E331-00.
    - c. Uniform Load Structural per ASTM E 330: Limit deflection to L/175.

- 1) Passed at Design Pressure of 20 psf (0.96 kPa).

## **PART 3 EXECUTION**

### 3.1 EXAMINATION

- A. Do not begin installation until substrates have been properly prepared.
- B. If substrate preparation is the responsibility of another installer, notify Architect of unsatisfactory preparation before proceeding.

### 3.2 PREPARATION

- A. Clean surfaces thoroughly prior to installation.
- B. Prepare surfaces using the methods recommended by the manufacturer for achieving the best result for the substrate under the project conditions.

### 3.3 INSTALLATION

- A. Install in accordance with manufacturer's instructions.

### 3.4 FIELD QUALITY CONTROL

- A. All joints between metal and masonry shall be fully caulked and field tested to resist water leakage with provisions taken to drain infiltrated water.

### 3.5 PROTECTION

- A. Protect installed products until completion of project.
- B. Touch-up, repair or replace damaged products before Substantial Completion.

END OF SECTION



**PL-400 SERIES**  
**1-3/4" X 4"**  
**1/4" CENTER GLAZED**

**PL-400 SERIES**  
 STOREFRONT MATERIAL



**SCREW RACE**

**QUICK SET**

**SCREW RACE**

**QUICK SET**

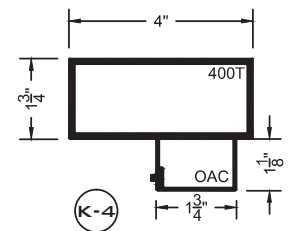
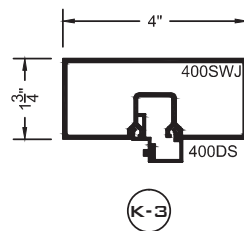
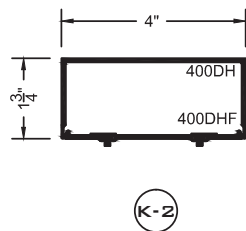
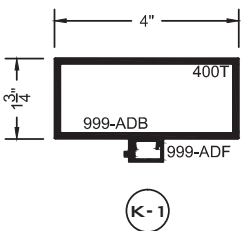
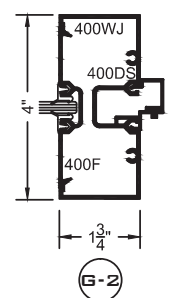
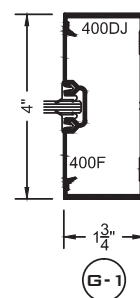
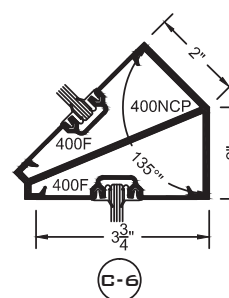
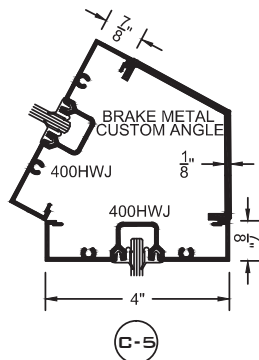
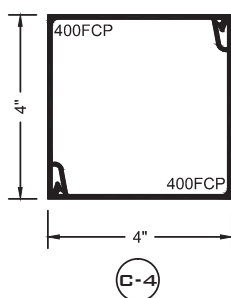
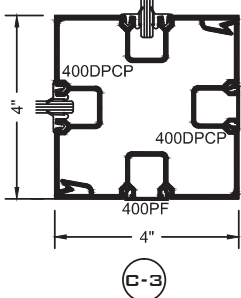
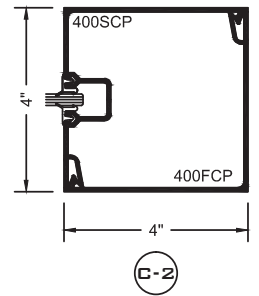
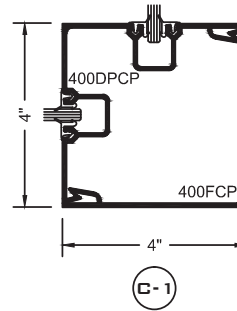
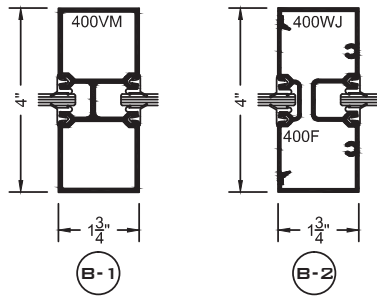
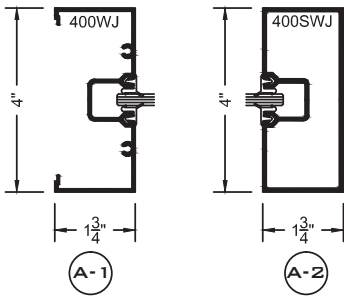
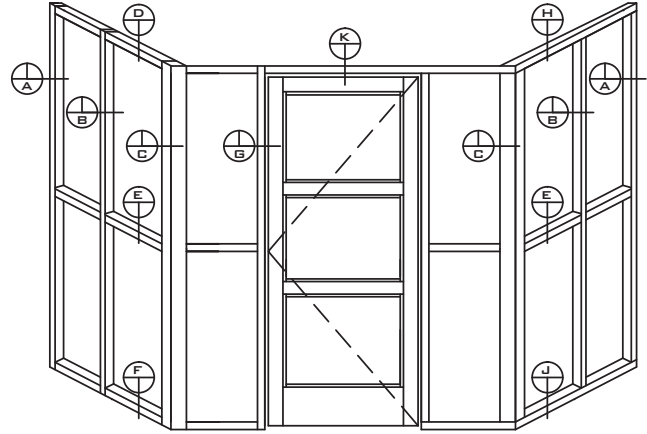
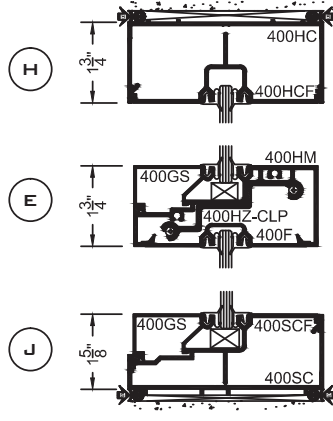
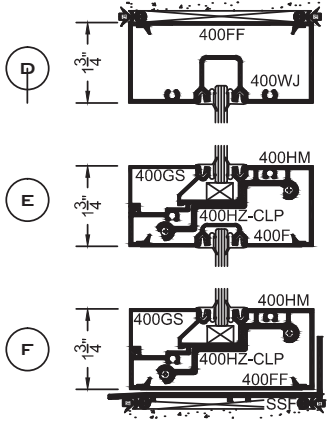

**PL-400 - 4**

ph: (877) 775-2586  
 fx: (877) 274-8800

14760 Don Julian Rd.  
 Industry, CA 91746

www.prlaluminum.com  
 sales@prlaluminum.com

**PL-400 SERIES**  
**1-3/4" X 4"**  
**FULL SCALE**

**QUICK SET** 

**H**

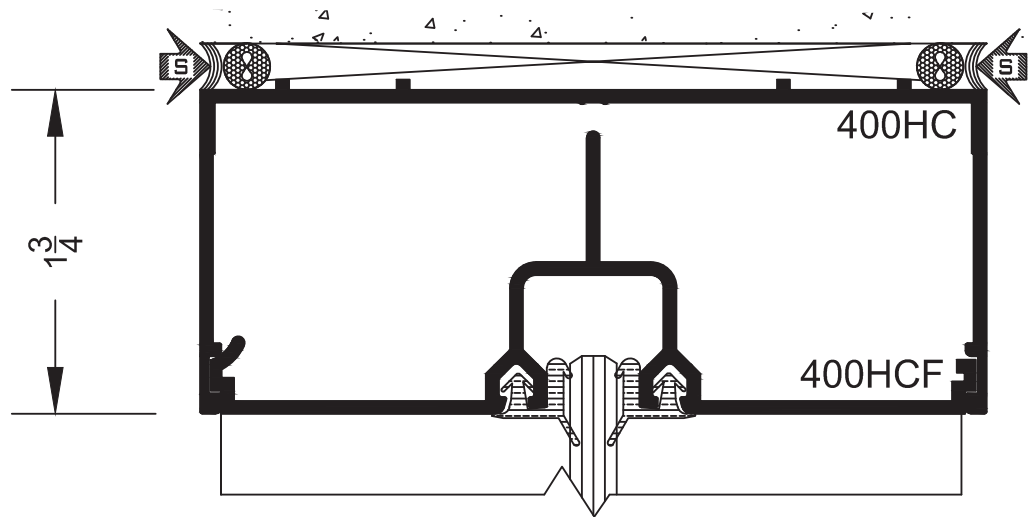

**E**

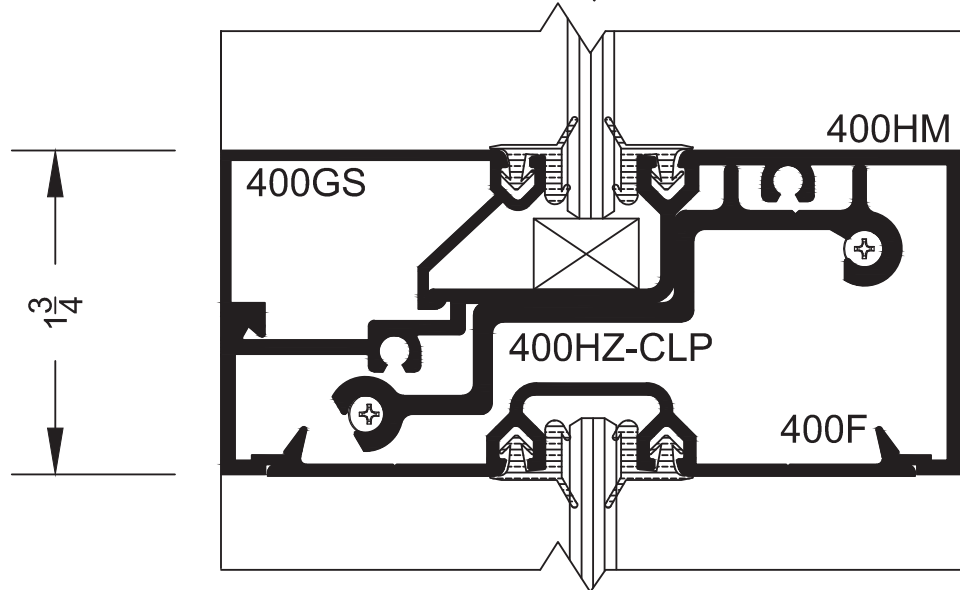

**J**

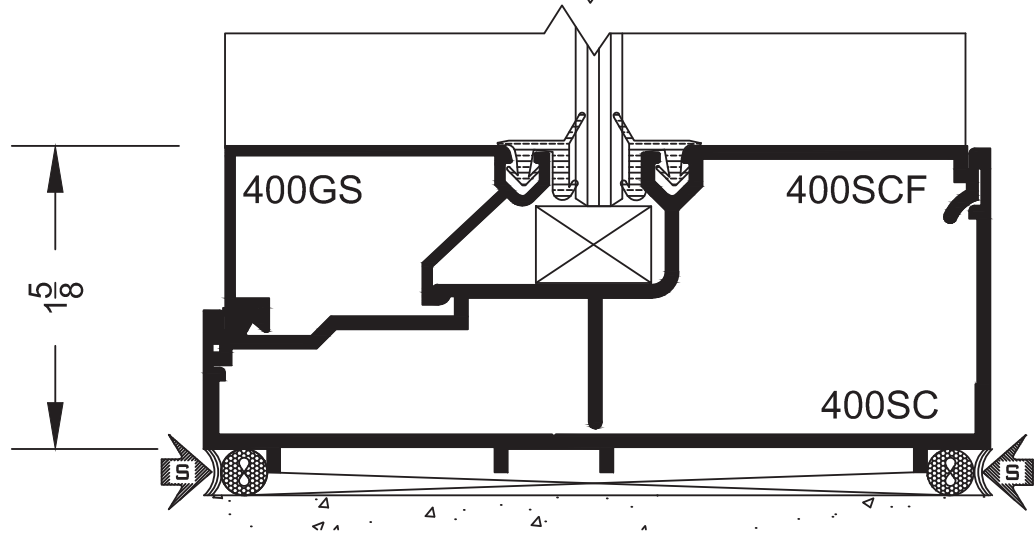

**PL-400 - 5**

ph: (877) 775-2586  
 fx: (877) 274-8800

14760 Don Julian Rd.  
 Industry, CA 91746

www.prlaluminum.com  
 sales@prlaluminum.com



**PL-400 SERIES**  
**1-3/4" X 4"**  
**FULL SCALE**

**SCREW RACE** 

**D**

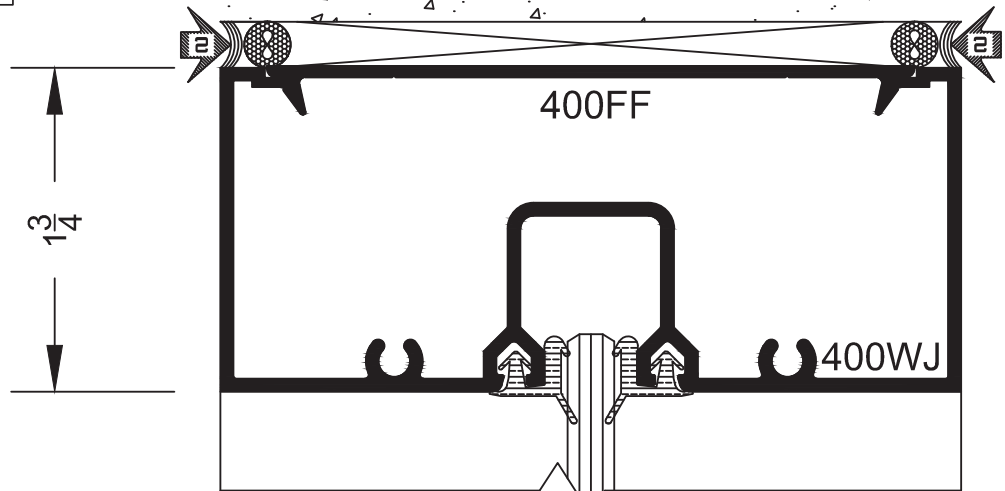

**E**

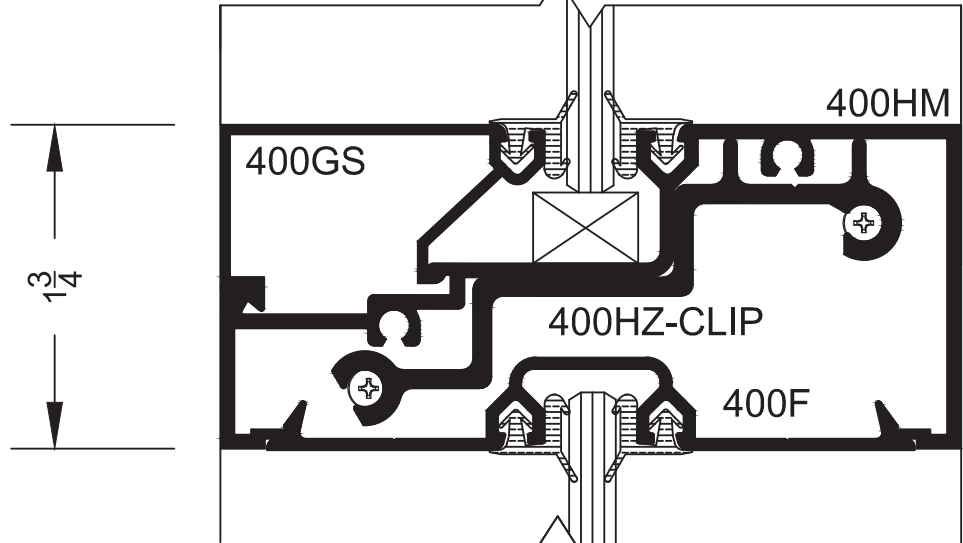

**F**

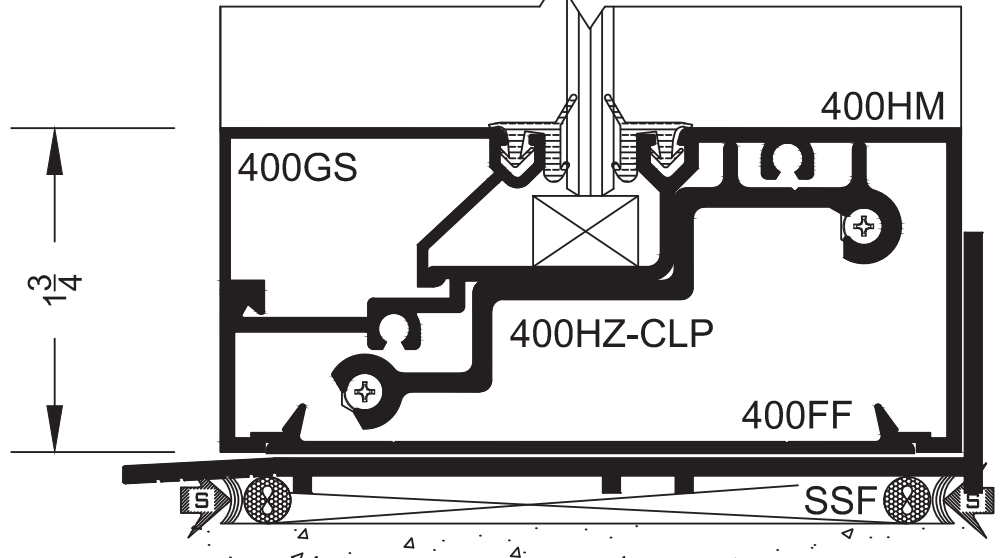

**PL-400 - 6**

ph: (877) 775-2586  
 fx: (877) 274-8800

14760 Don Julian Rd.  
 Industry, CA 91746

www.prlaluminum.com  
 sales@prlaluminum.com

**PL-400 SERIES**  
**1-3/4" X 4"**  
**FULL SCALE**

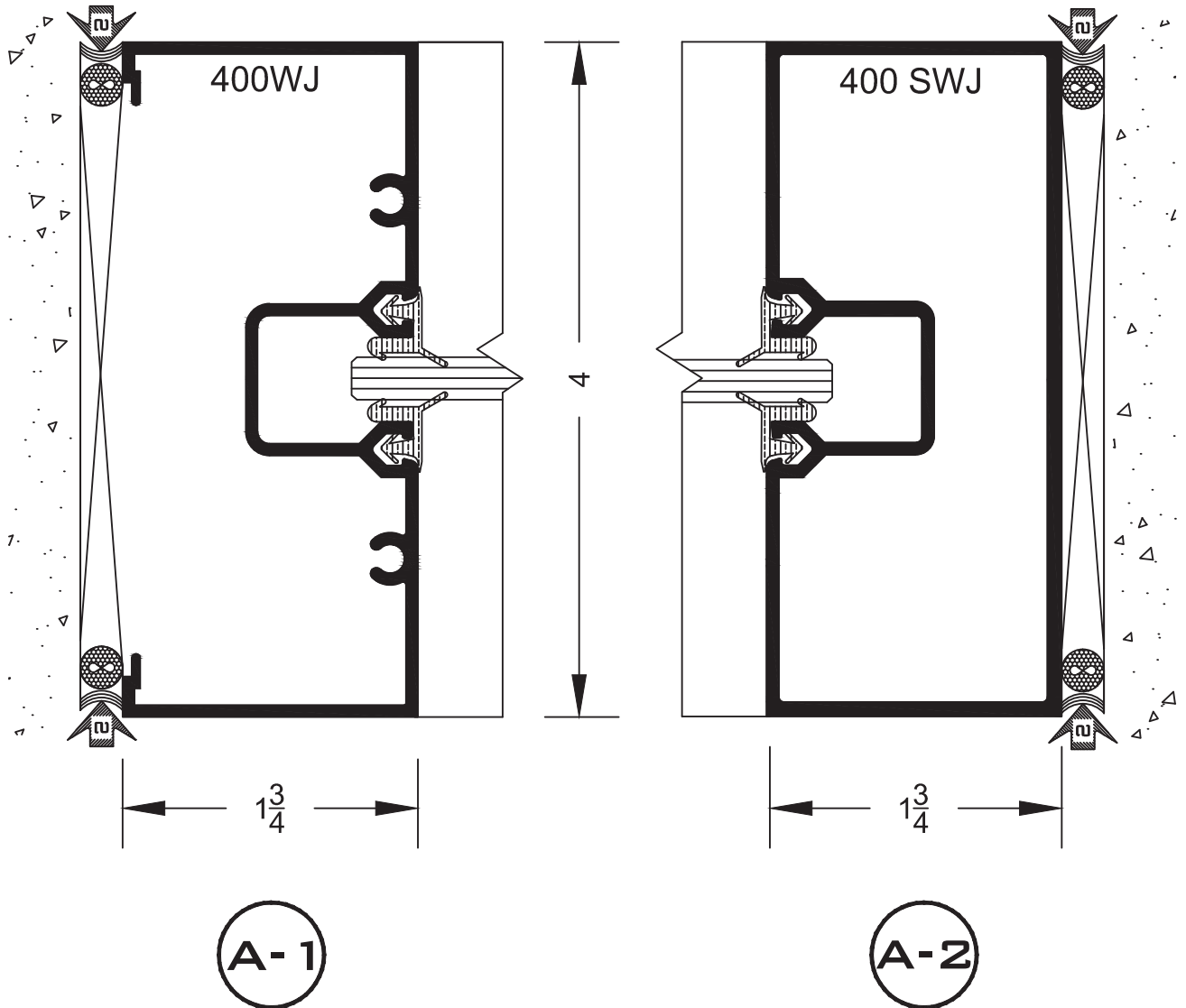

ph: (877) 775-2586  
fx: (877) 274-8800

**PL-400 - 7**  
14760 Don Julian Rd.  
Industry, CA 91746

[www.prlaluminum.com](http://www.prlaluminum.com)  
[sales@prlaluminum.com](mailto:sales@prlaluminum.com)

**PL-400 SERIES**  
**1-3/4" X 4"**  
**FULL SCALE**

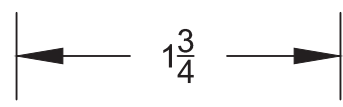
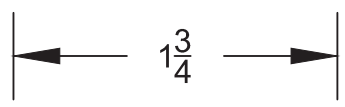
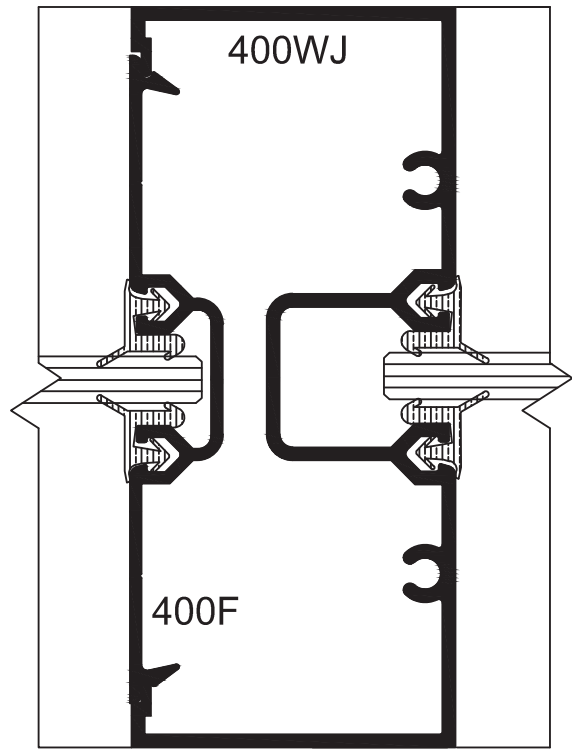
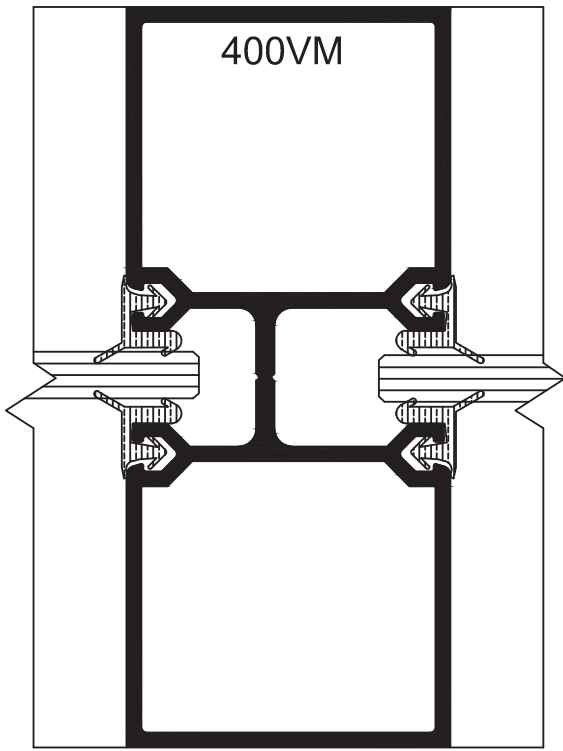

**B-1**

**B-2**

**PL-400 SERIES**  
**1-3/4" X 4"**  
**FULL SCALE**

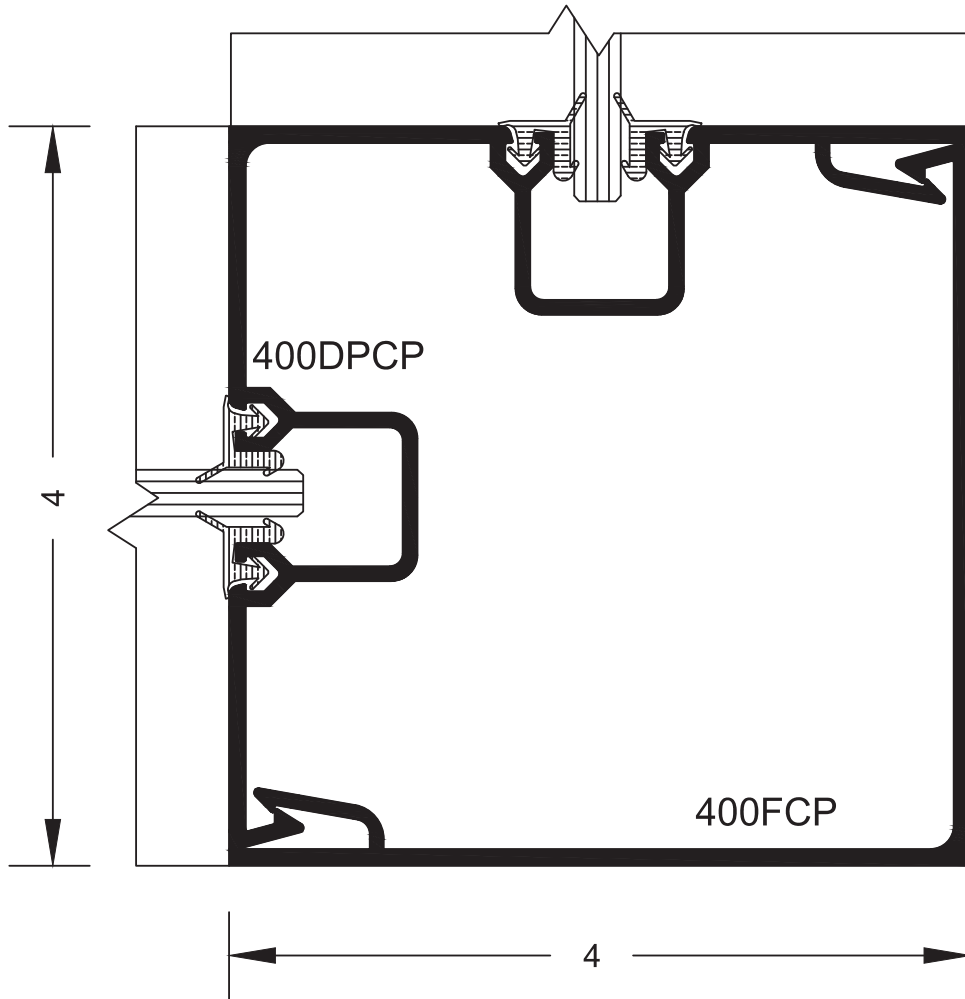

**C-1**

**PL-400 SERIES**  
**1-3/4" X 4"**  
**FULL SCALE**

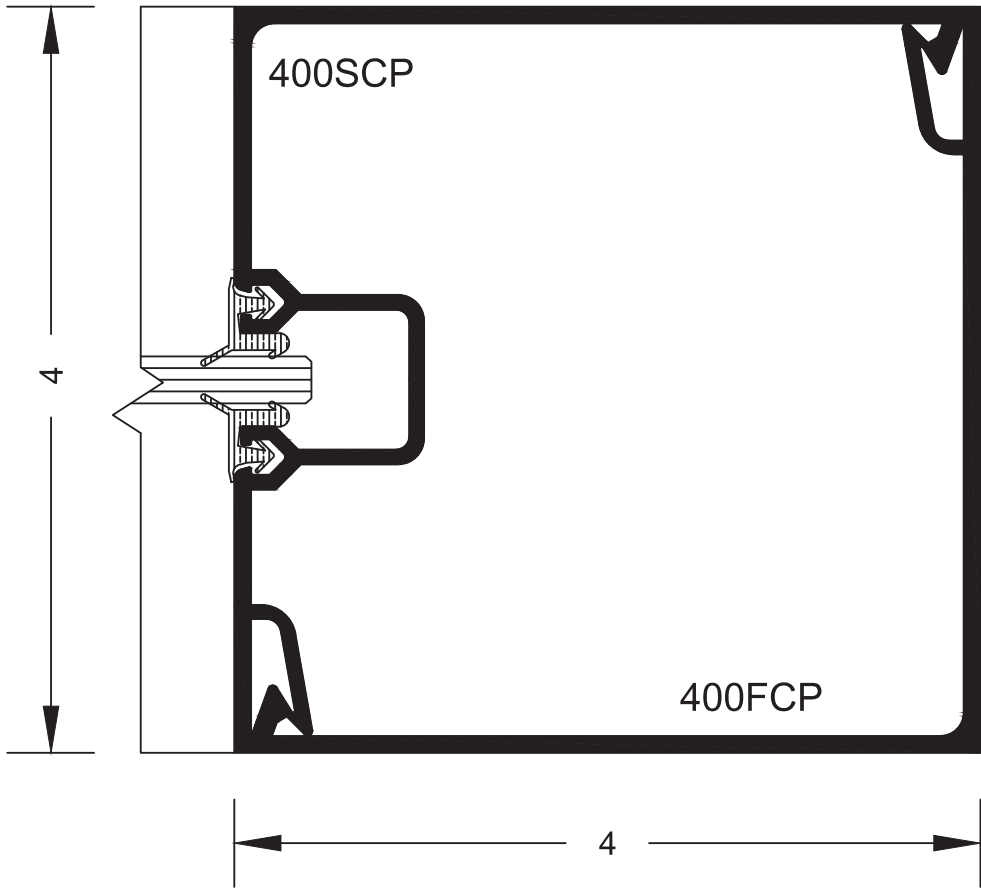

**C-2**

**PL-400 SERIES**  
**1-3/4" X 4"**  
**FULL SCALE**

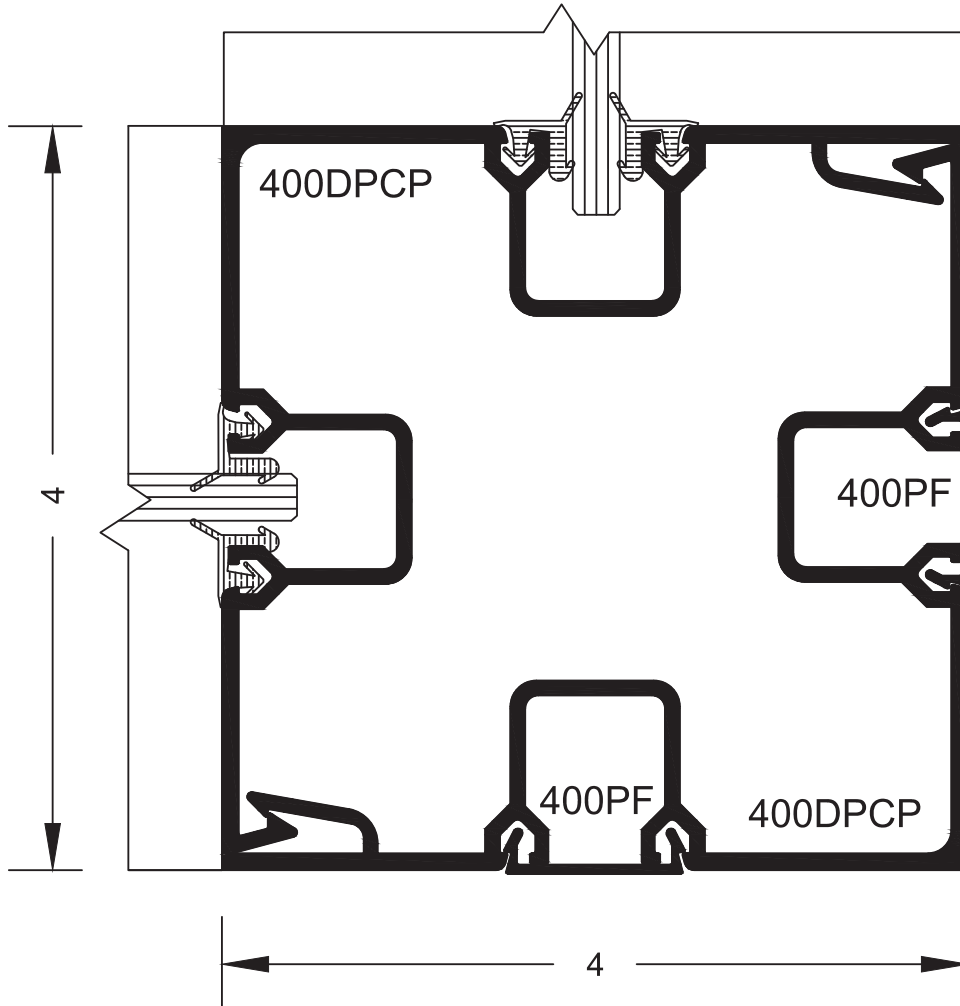

**C-3**

**PL-400 SERIES**  
**1-3/4" X 4"**  
**FULL SCALE**

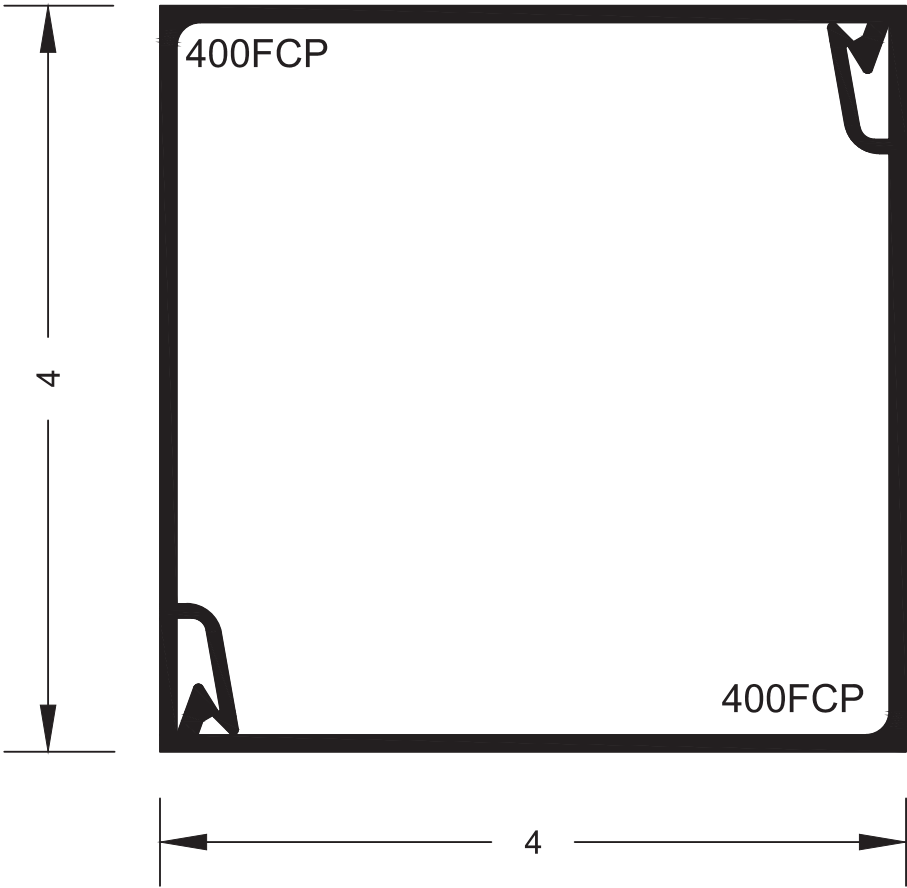

**C-4**

**PL-400 SERIES**  
**1-3/4" X 4"**  
**FULL SCALE**

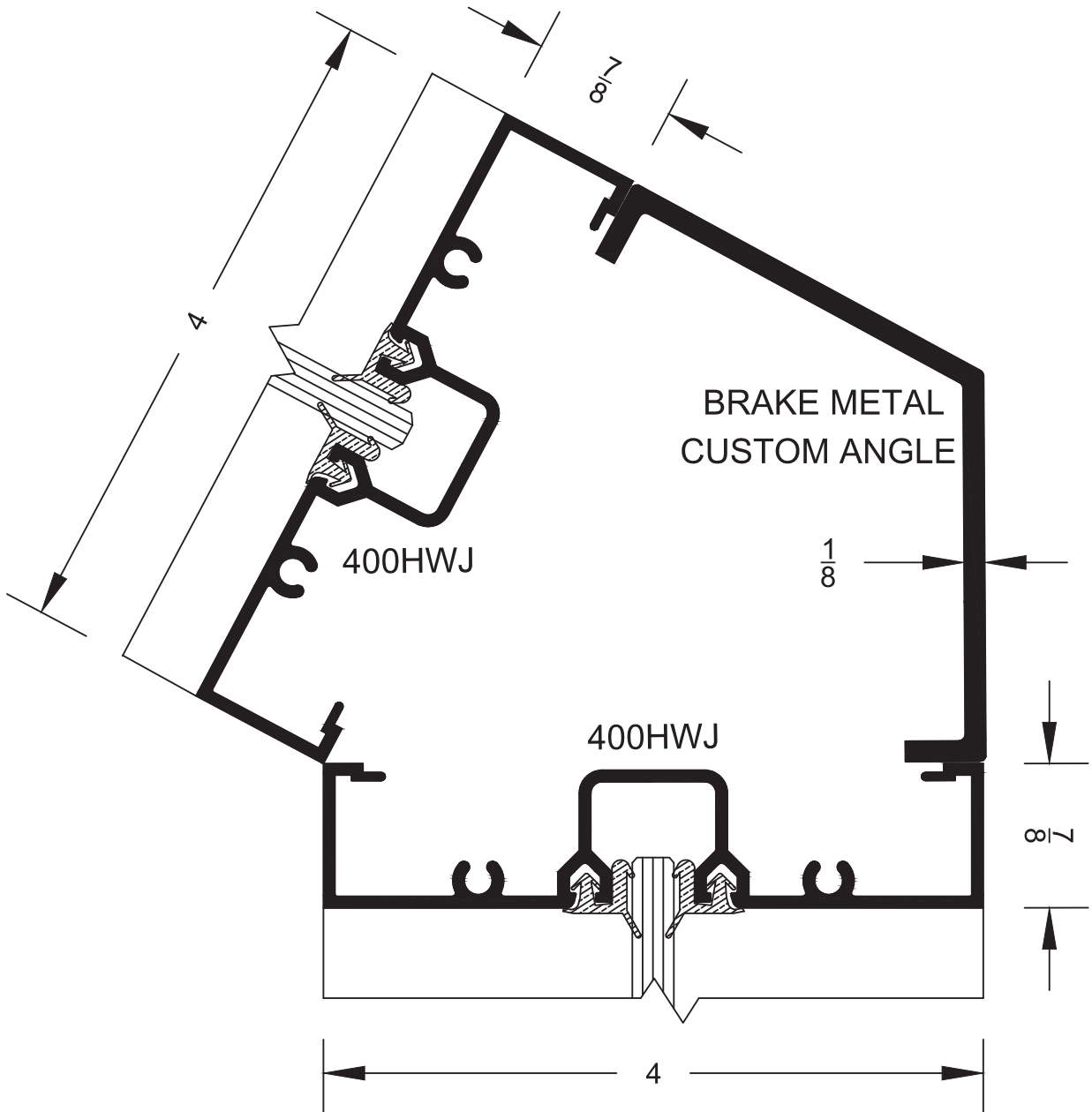

**C-6**

ph: (877) 775-2586  
fx: (877) 274-8800

**PL-400 - 13**  
14760 Don Julian Rd.  
Industry, CA 91746

[www.prlaluminum.com](http://www.prlaluminum.com)  
[sales@prlaluminum.com](mailto:sales@prlaluminum.com)



**PL-400 SERIES**  
**1-3/4" X 4"**  
**FULL SCALE**

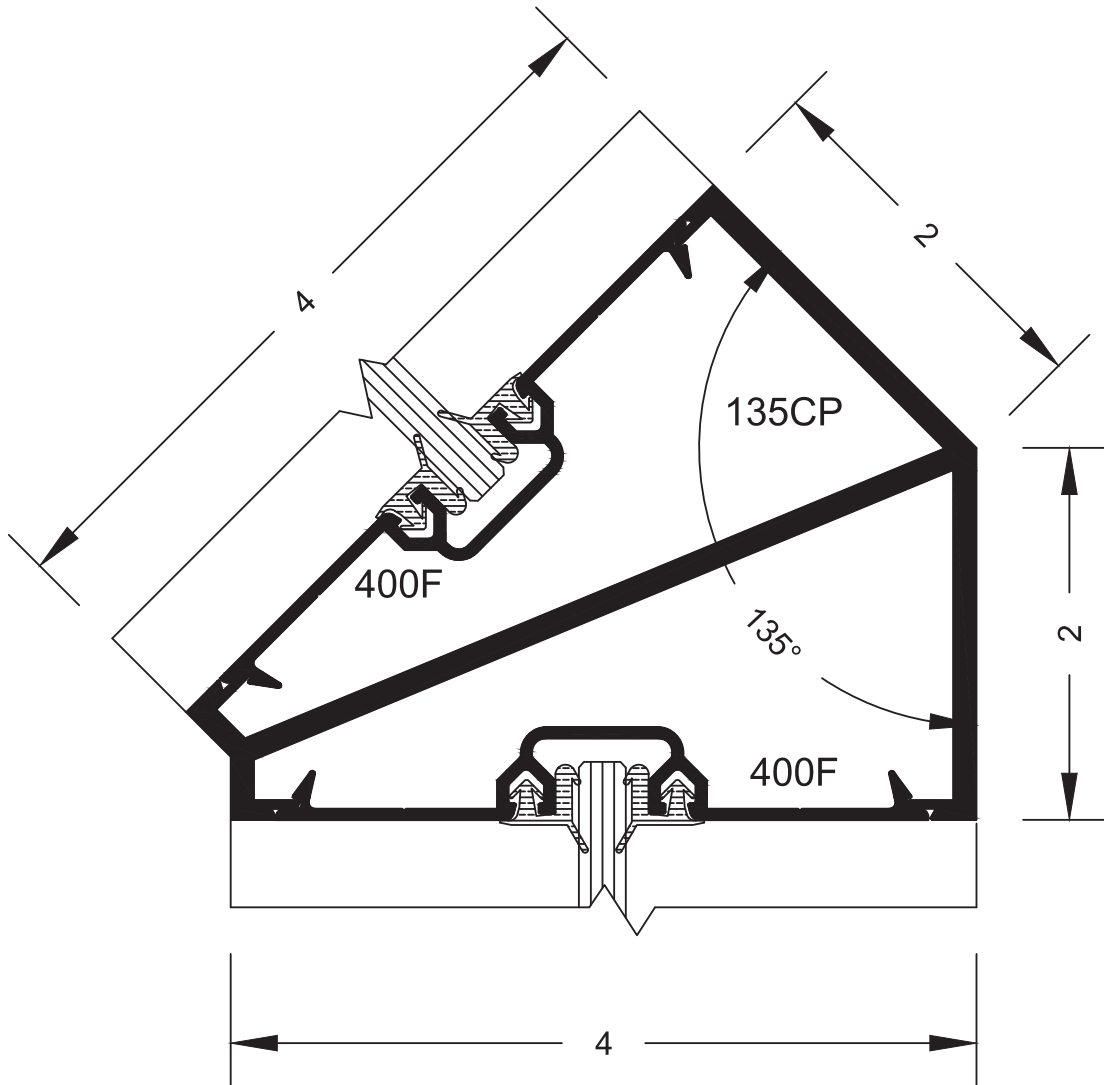

**C-5**

ph: (877) 775-2586  
fx: (877) 274-8800

**PL-400 - 14**  
14760 Don Julian Rd.  
Industry, CA 91746

[www.prlaluminum.com](http://www.prlaluminum.com)  
[sales@prlaluminum.com](mailto:sales@prlaluminum.com)

**PL-400 SERIES**  
**1-3/4" X 4"**  
**FULL SCALE**

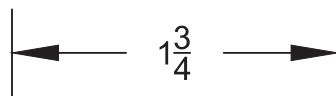
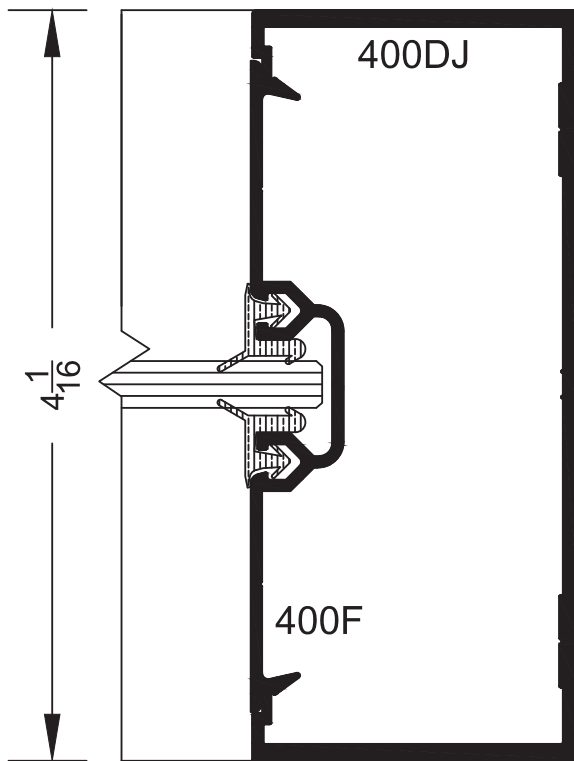

**G-1**

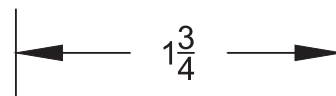
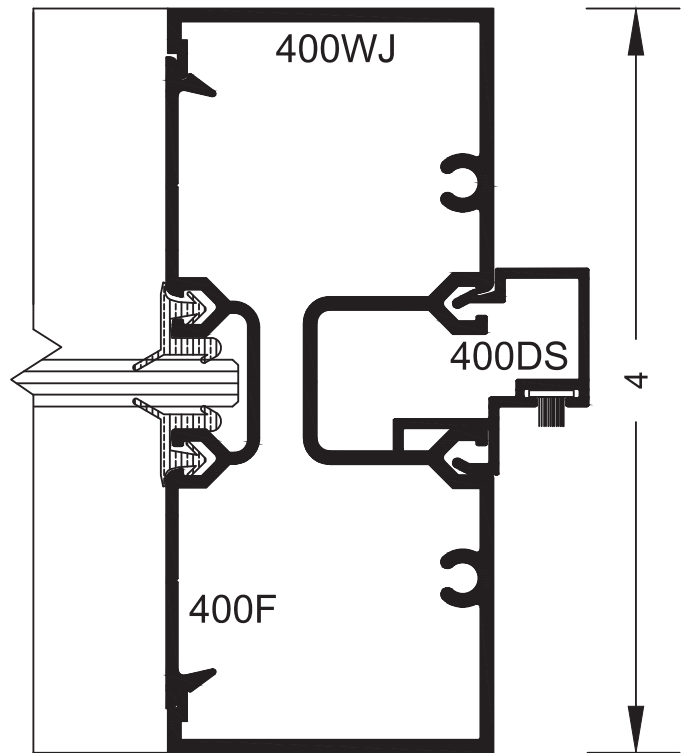

**G-2**

**PL-400 SERIES**  
**1-3/4" X 4"**  
**FULL SCALE**



**K-1**

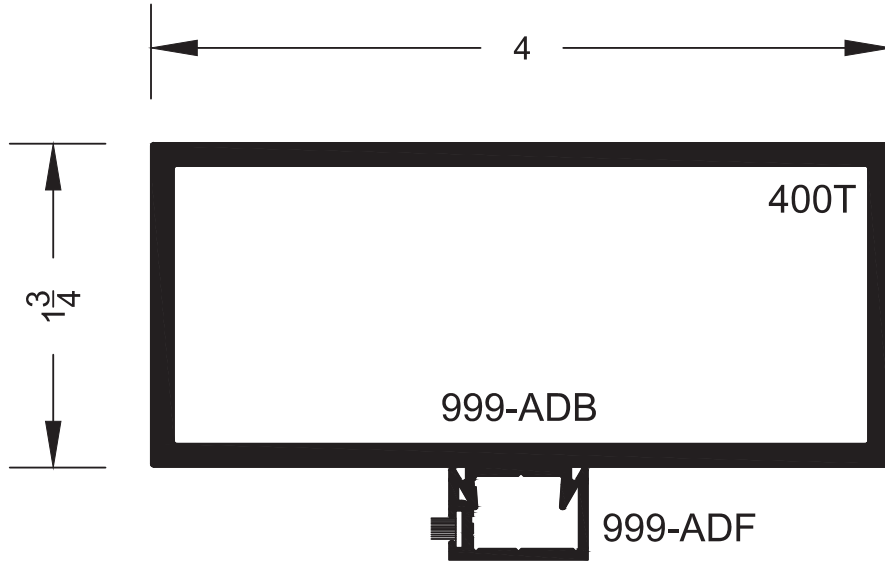

**K-2**

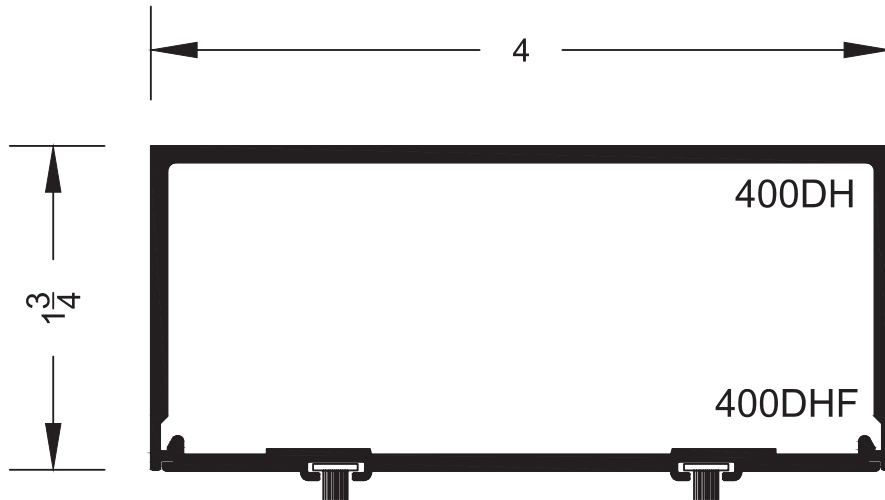

**PL-400 SERIES**  
**1-3/4" X 4"**  
**FULL SCALE**



**K-3**

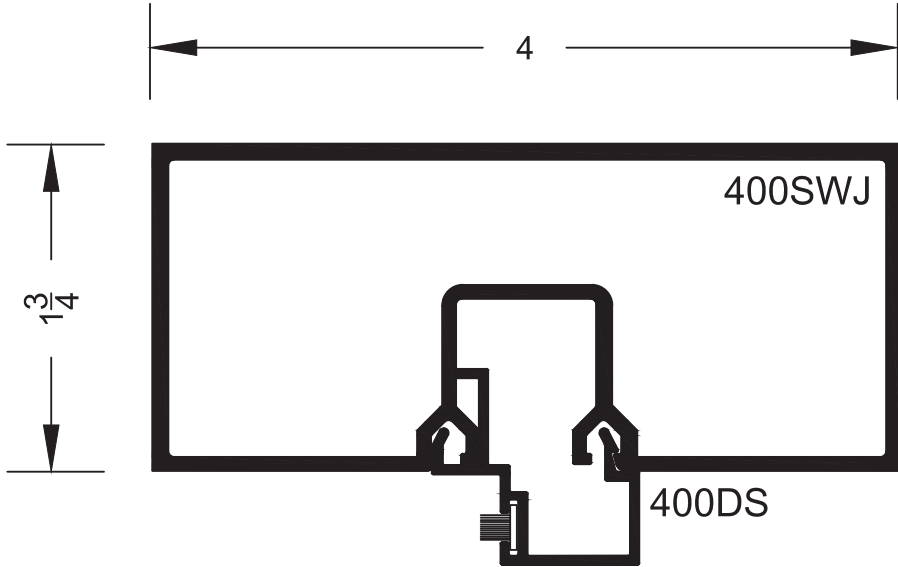

**K-4**

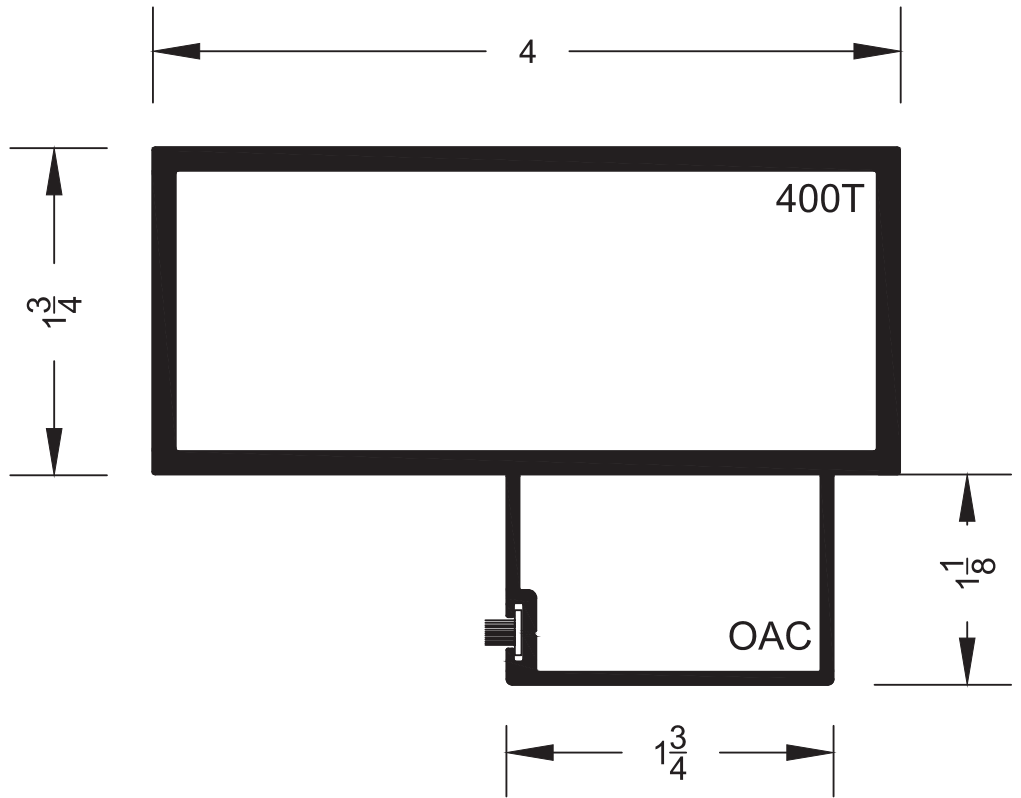

**PL-400 SERIES**  
**1-3/4" X 4"**  
**FULL SCALE**



## VINYL SASH

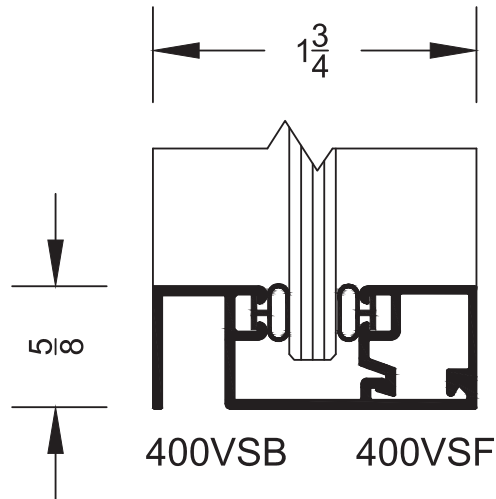

## CLIP SASH

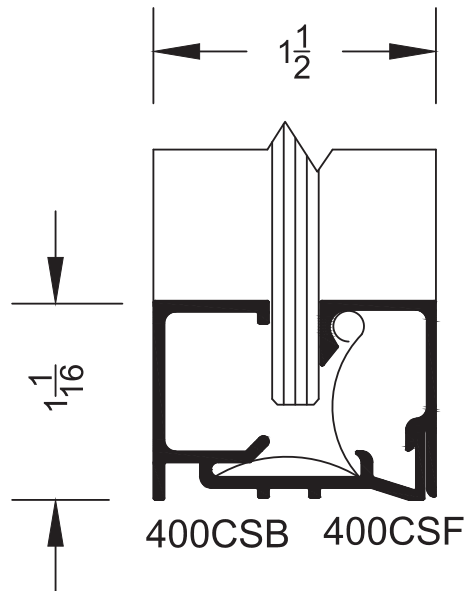



## WIND LOAD DESIGN

GLAZING FRAMING SHALL BE DESIGNED NOT TO EXCEED L/175, RATIO CURVES SHALL REPRESENT LIMIT.

VALUES ARE BASED ON CRITERIA FOR SIMPLE BEAM UNIFORMLY LOADED.

ALLOWABLE STRESSES FOR 6063-T5 ALUMINUM ALLOY = 9500 P.S.I.  
ALLOWABLE STRESSES FOR A-36 STRUCTURAL STEEL = 21600 P.S.I.

MAXIMUM DEFLECTION BETWEEN SUPPORTS FOR SINGLE SPAN:

$$\Delta = \frac{5WL^3}{384EI}$$

MAXIMUM BENDING MOMENT FOR SINGLE SPAN:

$$M = \frac{WL}{8}$$

NOTATIONS REPRESENT:

W = TOTAL UNIFORM LOAD

L = LENGTH OF MULLION BETWEEN SUPPORTS

E =  $10 \times 10^6$  P.S.I.

I = MOMENT OF INERTIA OF MULLION

M = BENDING MOMENT

NOTE:

MULLIONS ARE ASSUMED TO HAVE EQUAL SIZE GLASS LIGHTS EACH SIDE

**PL-400 SERIES**  
**1-3/4" X 4"**  
**WIND LOAD**



400 WALL JAMB WITH FILLER

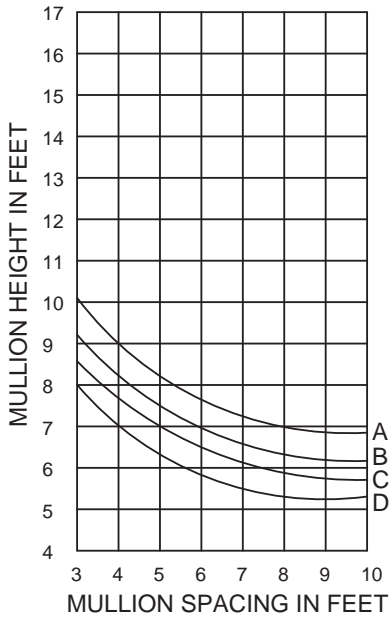

$I_{102} = 1.630 \text{ IN}^4$   
 $S_{102} = 0.815 \text{ IN}^3$



400 TUBE

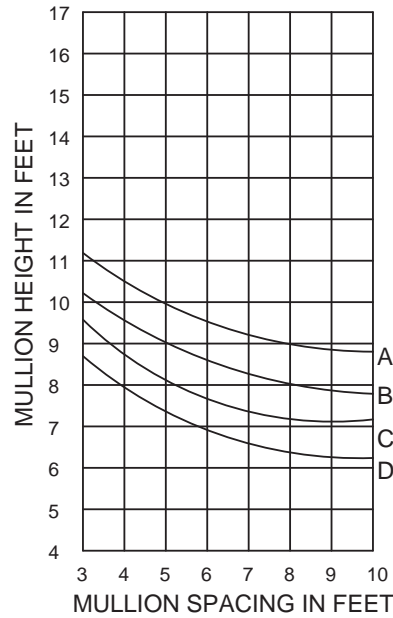

$I = 2.040 \text{ IN}^4$   
 $S = 1.20 \text{ IN}^3$



CURVE REPRESENTATION  
 A = 15 P.S.F. ( 75 M.P.H )  
 B = 20 P.S.F. ( 90 M.P.H )  
 C = 25 P.S.F. ( 100 M.P.H )  
 D = 30 P.S.F. ( 110 M.P.H )

400 WALL JAMB & FILLER WITH STEEL REINFORCEMENT

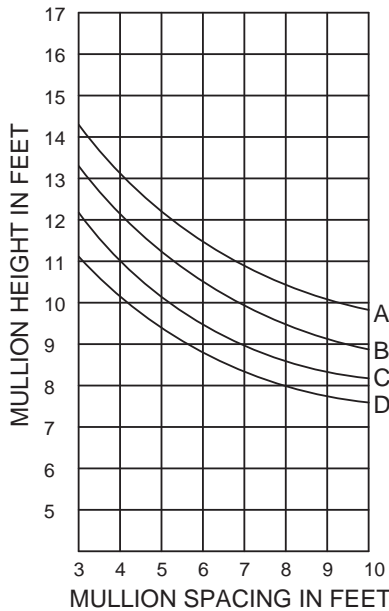

$I_{102/STL} = 4.642 \text{ IN}^4$   
 $S_{102/STL} = 1.672 \text{ IN}^3$

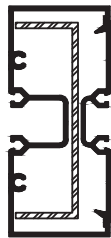

400 TUBE WITH STEEL REINFORCEMENT

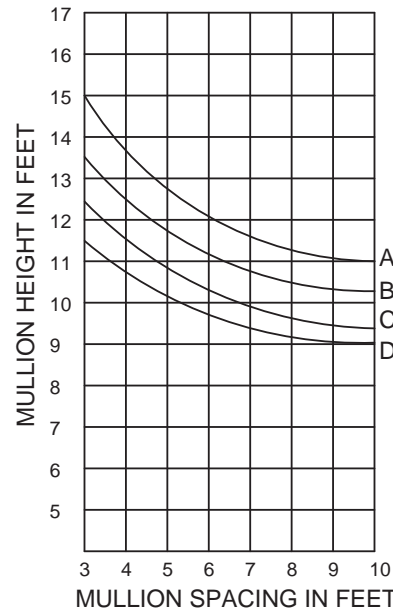

$I = 5.052 \text{ IN}^4$   
 $S = 2.526 \text{ IN}^3$



**PL-400 SERIES**  
**1-3/4" X 4"**  
**WIND LOAD**



400 DOOR JAMB WITH FILLER

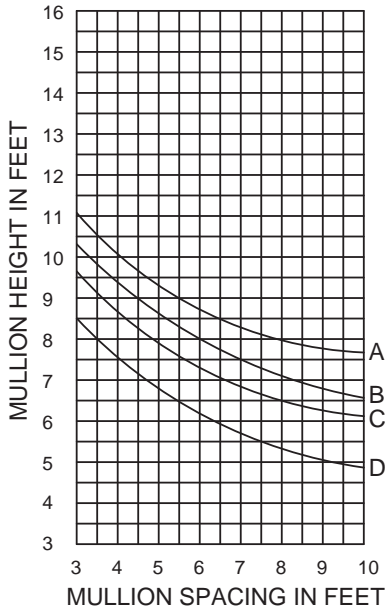

$I = 1.892 \text{ IN}^4$   
 $S = 0.841 \text{ IN}^3$



400 DOUBLE POCKET WITH  
 400 DOUBLE POCKET

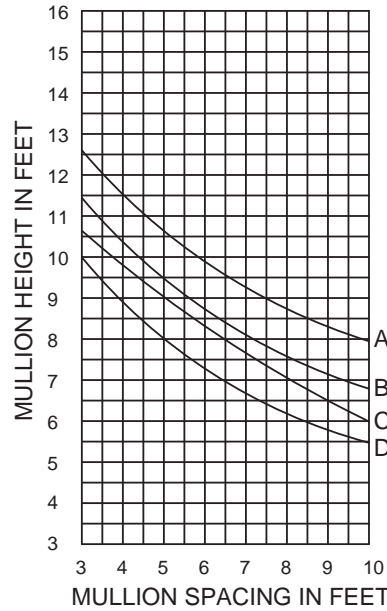

$I = 3.054 \text{ IN}^4$   
 $S = 1.082 \text{ IN}^3$

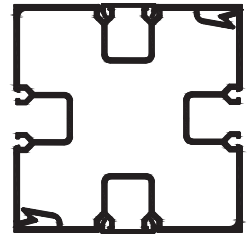

CURVE REPRESENTATION  
 A = 15 P.S.F. ( 75 M.P.H )  
 B = 20 P.S.F. ( 90 M.P.H )  
 C = 25 P.S.F. ( 100 M.P.H )  
 D = 30 P.S.F. ( 110 M.P.H )

400 DOOR JAMB & FILLER  
 WITH STEEL REINFORCEMENT

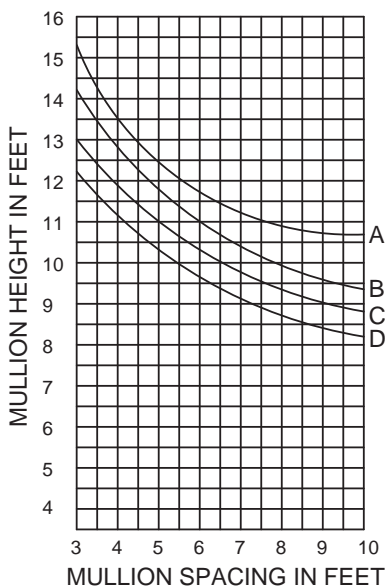

$I = 5.601 \text{ IN}^4$



400 DOUBLE POCKET  
 WITH 400 CORNER POST

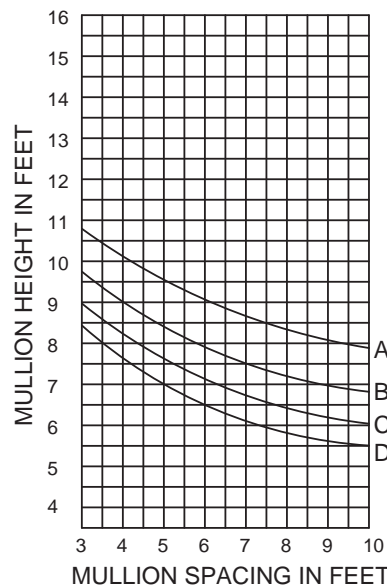

$I = 1.303 \text{ IN}^4$   
 $S = 0.802 \text{ IN}^3$

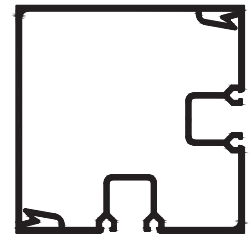



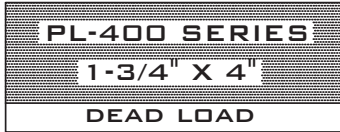

## DEAD LOAD DESIGN

GLAZING FRAMING SHALL BE DESIGNED NOT TO EXCEED L/360 OR 1/8" DEFLECTION WHICHEVER IS LES, RATIO CURVES SHALL REPRESENT LIMIT.

VALUES ARE BASED ON CRITERIA FOR SIMPLE BEAM UNIFORMLY LOADED.

ALLOWABLE STRESSES FOR 6063-T5 ALUMINUM ALLOY = 9500 P.S.I.  
ALLOWABLE STRESSES FOR A-36 STRUCTURAL STEEL = 21600 P.S.I.

MAXIMUM DEFLECTION BETWEEN SUPPORTS FOR SINGLE SPAN:

$$\Delta = \frac{Pa}{24EI} (3L^2 - 4a^2)$$

MAXIMUM BENDING MOMENT FOR SINGLE SPAN:

$$M = Pa$$

NOTATIONS REPRESENT:

P = 1/2 GLASS LOAD

a = 1/4 OR 1/8 POINT OF SPAN (INCHES)

E =  $10 \times 10^6$  P.S.I.

I = MOMENT OF INERTIA OF MULLION

L = LENGTH HORIZONTAL SPAN

<b>PL-400 SERIES</b>
<b>1-3/4" X 4"</b>
<b>DEAD LOAD</b>



400 HORIZONTAL MULLION

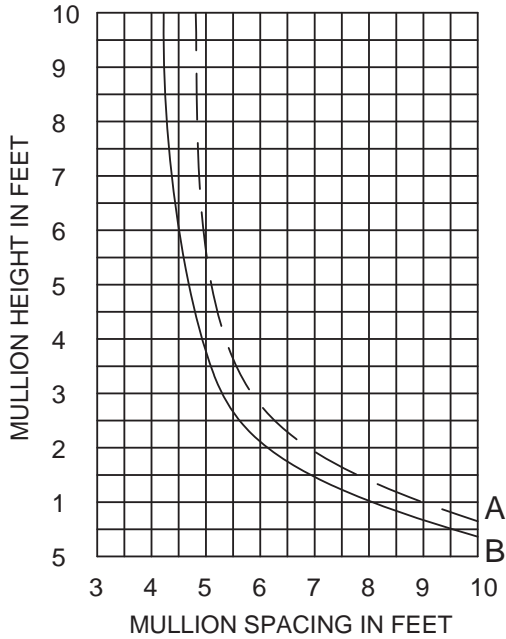

$I = 0.201 \text{ IN}^4$       MAX ALLOW DEFLECTION  $L/360$   
 $S = 0.203 \text{ IN}^3$       OR  $1/8"$  WHICHEVER IS LESS

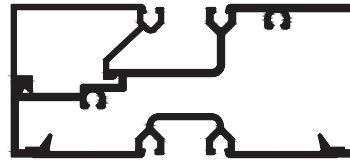

**CURVE REPRESENTATION**  
 (A) ( - - - - ) = 1/8 PTS. OR A MINIMUM OF 8" AWAY FROM THE EDGE OF GLASS  
 (B) ( ——— ) = 1/4 PTS. A MINIMUM OF 8" AWAY FROM THE EDGE OF GLASS

# **401 SERIES**

1 3/4" x 4"

SECTION

# **401 SERIES**

1 3/4" x 4"

SECTION



## ALUMINUM STOREFRONTS PL-401 SERIES

### **PART 1 GENERAL**

#### 1.1 SECTION INCLUDES

- A. Aluminum storefronts.

#### 1.2 REFERENCES

- A. ASTM International (ASTM):
  1. ASTM B 221 - Standard Specification for Aluminum and Aluminum-Alloy Extruded Bars, Rods, Wire, Profiles, and Tubes.
  2. ASTM E 283 - Test Method for Determining the Rate of Air Leakage Through Exterior Windows, Curtain Walls, and Doors under Specified Pressure Differences across the Specimen.
  3. ASTM E 330 - Standard Test Method for Structural Performance of Exterior Windows, Doors, Skylights and Curtain Walls by Uniform Static Air Pressure Difference.
  4. ASTM E 331 - Test Method for Water Penetration of Exterior Windows, Curtain Walls, and Doors by Uniform Static Air Pressure Difference.

#### 1.3 SUBMITTALS

- A. Submit under provisions of applicable Requirements.
- B. Product Data: Manufacturer's data sheets on each product to be used, including:
  1. Preparation instructions and recommendations.
  2. Storage and handling requirements and recommendations.
  3. Installation methods.
- C. Shop Drawings: Configuration and details for installation, maintenance and operation.
- D. Selection Samples: For each finish product specified, two complete sets of color chips representing manufacturer's full range of available colors and patterns.
- E. Verification Samples: For each finish product specified, two samples, minimum size 6 inches (150 mm) square representing actual product, color, and patterns.

#### 1.4 QUALITY ASSURANCE

- A. Manufacturer Qualifications: Minimum 5 year experience manufacturing similar products.
- B. Installer Qualifications: Minimum 2 year experience installing similar products.
- C. Mock-Up: Provide a mock-up for evaluation of surface preparation techniques and application workmanship.
  1. Finish areas designated by Architect.
  2. Do not proceed with remaining work until workmanship is approved by Architect.
  3. Refinish mock-up area as required to produce acceptable work.

#### 1.5 PRE-INSTALLATION MEETINGS

### **PL-401 - 1**

- A. Convene minimum two weeks prior to starting work of this section.

#### 1.6 DELIVERY, STORAGE, AND HANDLING

- A. Deliver and store products in manufacturer's unopened packaging bearing the brand name and manufacturer's identification until ready for installation.
- B. Handling: Handle materials to avoid damage.

#### 1.7 PROJECT CONDITIONS

- A. Maintain environmental conditions (temperature, humidity, and ventilation) within limits recommended by manufacturer for optimum results. Do not install products under environmental conditions outside manufacturer's recommended limits.

#### 1.8 SEQUENCING

- A. Ensure that products of this section are supplied to affected trades in time to prevent interruption of construction progress.

### **PART 2 PRODUCTS**

#### 2.1 MANUFACTURERS

- A. Acceptable Manufacturer: PRL Glass Systems, Inc., which is located at: 13644 Nelson Ave.; City of Industry, CA 91746; Toll Free Tel: 800-433-7044; Fax: 626-968-9256; Email: request; Web:[prlglass.com](http://prlglass.com)
- B. Substitutions: Not permitted.
- C. Requests for substitutions will be considered in accordance with provisions of Section 01 60 00 - Product Requirements.

#### 2.2 ALUMINUM STOREFRONT

- A. Product: Aluminum Storefront Series as manufactured by PRL Glass Systems, Inc.
- B. Design:
  - 1. Framing sections shall be extruded from 6063-T5 aluminum alloy.
  - 2. Glazing beads shall be NS (non-stretch, high-shore) vinyl used on both sides of the glass. Vinyl shall incorporate a fiberglass cord bonded with the vinyl.
  - 3. Sections shall conform to details and shall present clean, straight, sharply defined lines, and shall be free from defects impairing strength or durability.
  - 4. Screws, nuts, bolts and fastening devices and internal components shall be of aluminum, stainless steel or other non-corrosive material.
  - 5. Factory preparation from detail drawings shall be so fabricated that field assembly will be able to produce accurate, tightly fitted joints.
- C. **401-Series (1-3/4 X 4 Offset Glaze for 1/4 Glazing):**
  - 1. Performance: (Test sample of 10 feet (3048 mm) wide by 10 feet (3048 mm) high - 3 lites wide by 2 lites high).
    - a. Air infiltration: Limit air leakage through fixed glazing and frames to 0.037 cfm/ft<sup>2</sup>/min when tested in accordance with ASTM E-283 at a cross pressure of 6.24 psf (0.30 kPa).
    - b. Water Penetration under Static Pressure: System shall not evidence uncontrolled water penetration at a cross pressure of 6 psf (0.29 kPa) when tested in accordance with ASTM-E331-00.
    - c. Uniform Load Structural per ASTM E 330: Limit deflection to L/175.

### **PL-401 - 2**

- 1) Passed at Design Pressure of 20 psf (0.96 kPa).

## **PART 3 EXECUTION**

### 3.1 EXAMINATION

- A. Do not begin installation until substrates have been properly prepared.
- B. If substrate preparation is the responsibility of another installer, notify Architect of unsatisfactory preparation before proceeding.

### 3.2 PREPARATION

- A. Clean surfaces thoroughly prior to installation.
- B. Prepare surfaces using the methods recommended by the manufacturer for achieving the best result for the substrate under the project conditions.

### 3.3 INSTALLATION

- A. Install in accordance with manufacturer's instructions.

### 3.4 FIELD QUALITY CONTROL

- A. All joints between metal and masonry shall be fully caulked and field tested to resist water leakage with provisions taken to drain infiltrated water.

### 3.5 PROTECTION

- A. Protect installed products until completion of project.
- B. Touch-up, repair or replace damaged products before Substantial Completion.

END OF SECTION





**PL-401 SERIES**  
**1-3/4" X 4"**  
**1/4" OFFSET GLAZED**

**PL-401 SERIES**  
 STOREFRONT MATERIAL



**SCREW RACE**

**QUICK SET**

**SCREW RACE**

**QUICK SET**

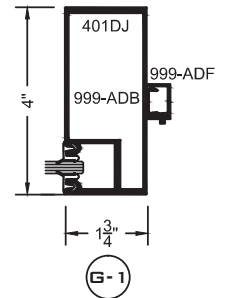
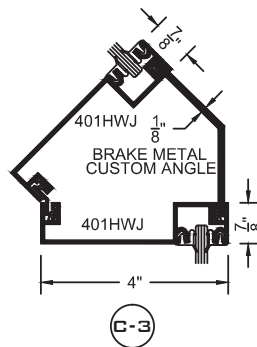
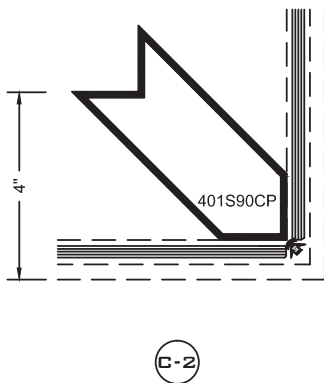
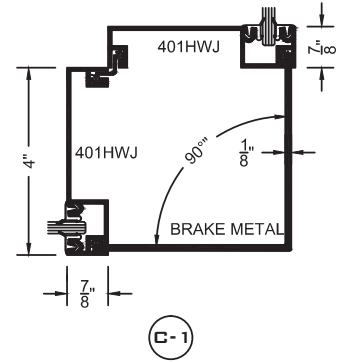
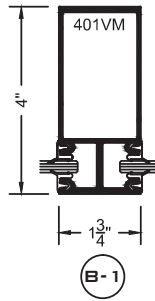
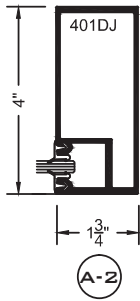
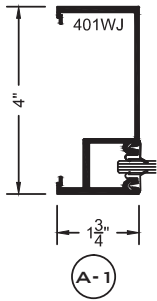
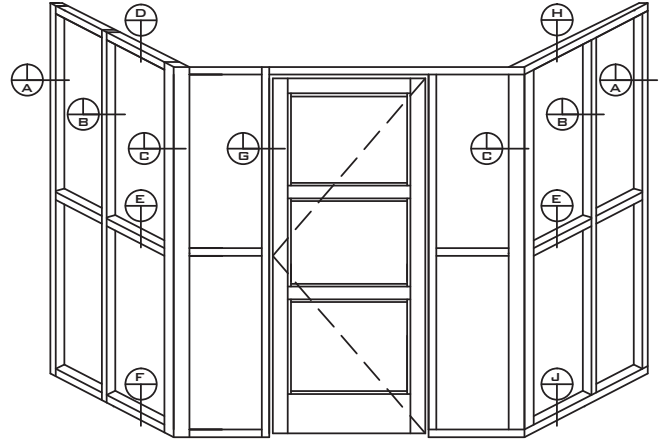
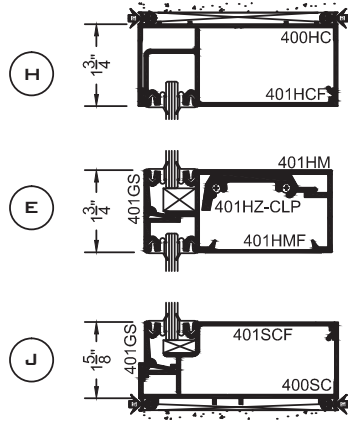
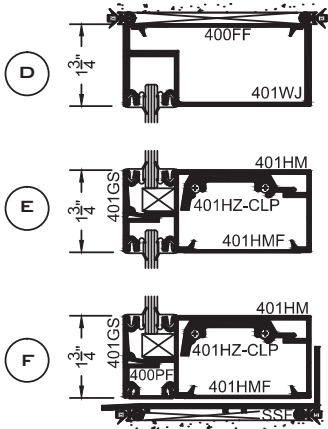

**PL-401 - 4**

ph: (877) 775-2586  
 fx: (877) 274-8800

14760 Don Julian Rd.  
 Industry, CA 91746

www.prlaluminum.com  
 sales@prlaluminum.com

**PL-401 SERIES**  
**1-3/4" X 4"**  
**FULL SCALE**

**QUICK SET**

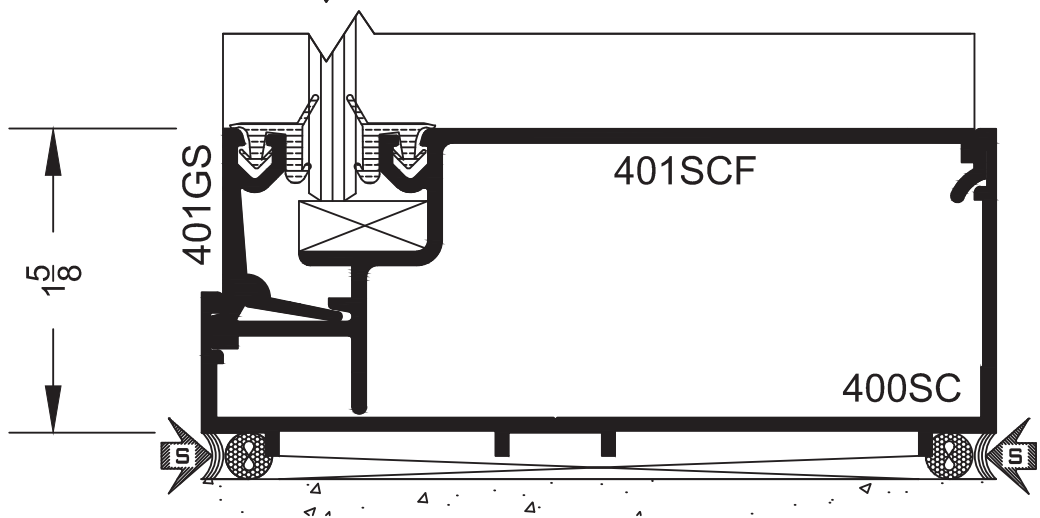
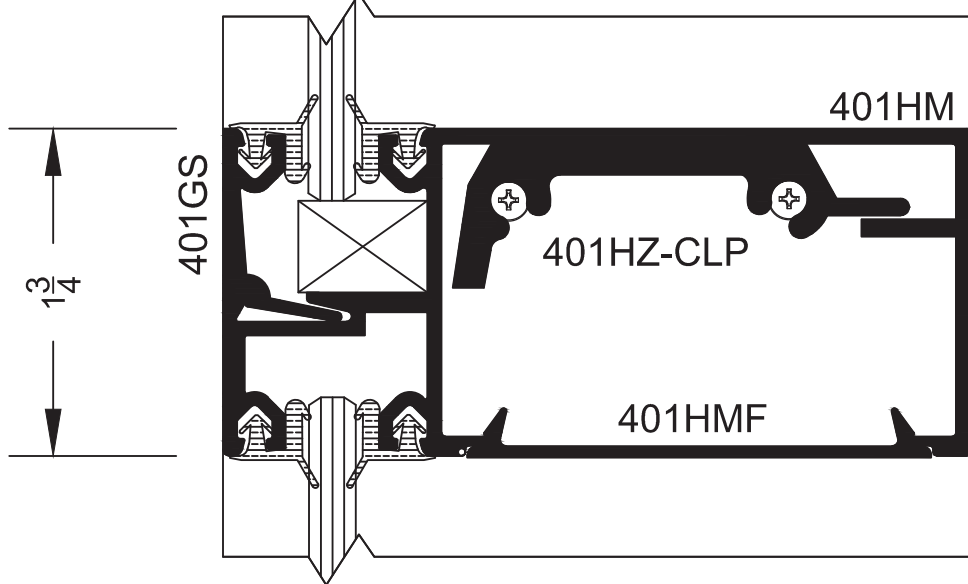
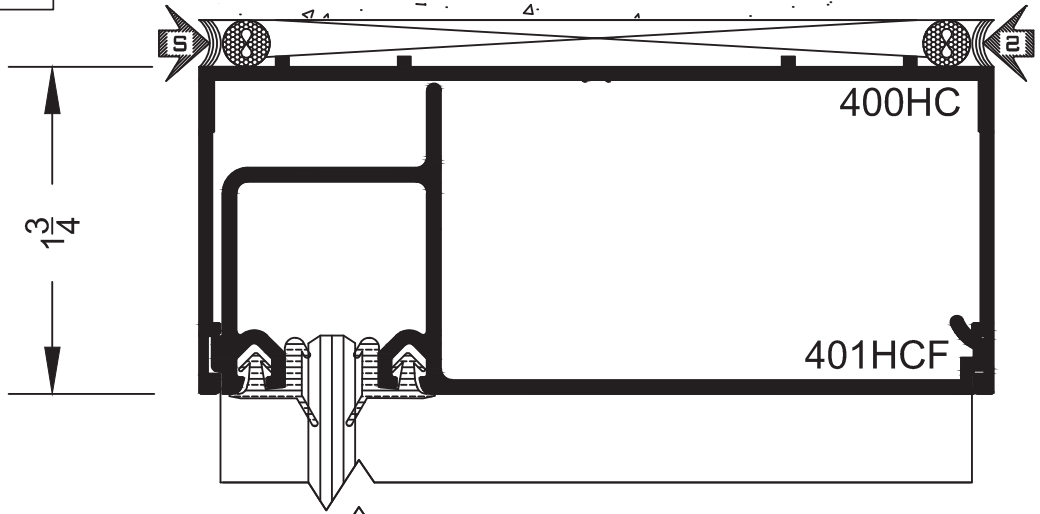

**PL-401 - 5**

14760 Don Julian Rd.  
 Industry, CA 91746

ph: (877) 775-2586  
 fx: (877) 274-8800

www.prlaluminum.com  
 sales@prlaluminum.com

PL-401 SERIES  
 1-3/4" X 4"  
 FULL SCALE

SCREW RACE



D

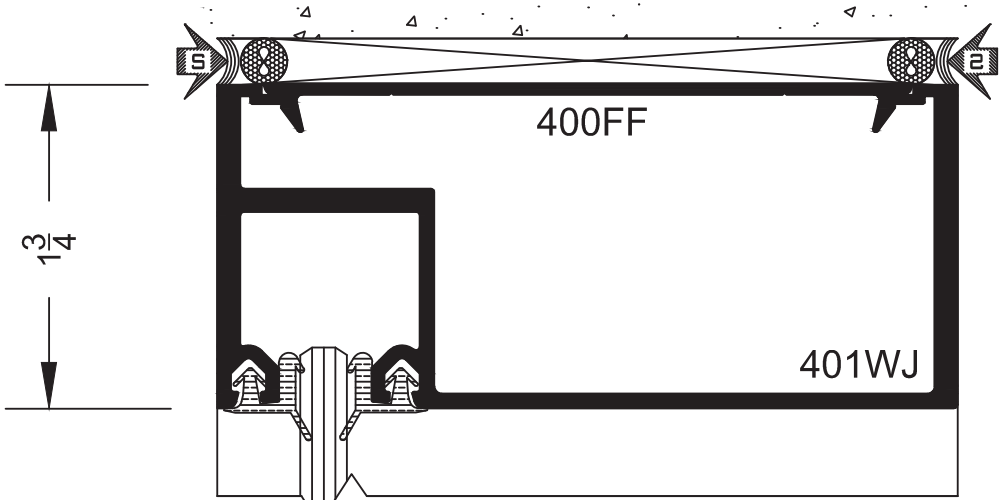

E

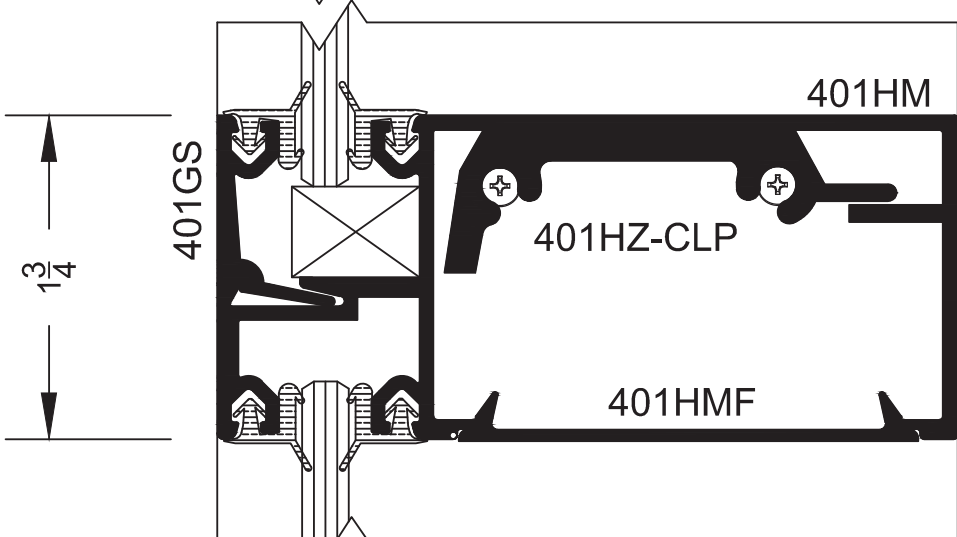

F

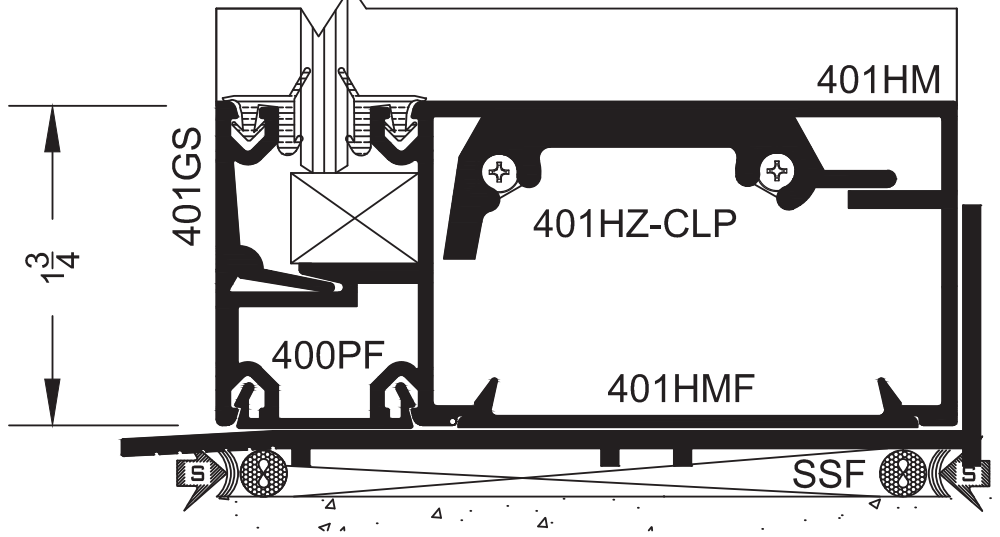

PL-401 - 6

14760 Don Julian Rd.  
 Industry, CA 91746

ph: (877) 775-2586  
 fx: (877) 274-8800

www.prlaluminum.com  
 sales@prlaluminum.com

**PL-401 SERIES**  
**1-3/4" X 4"**  
**FULL SCALE**

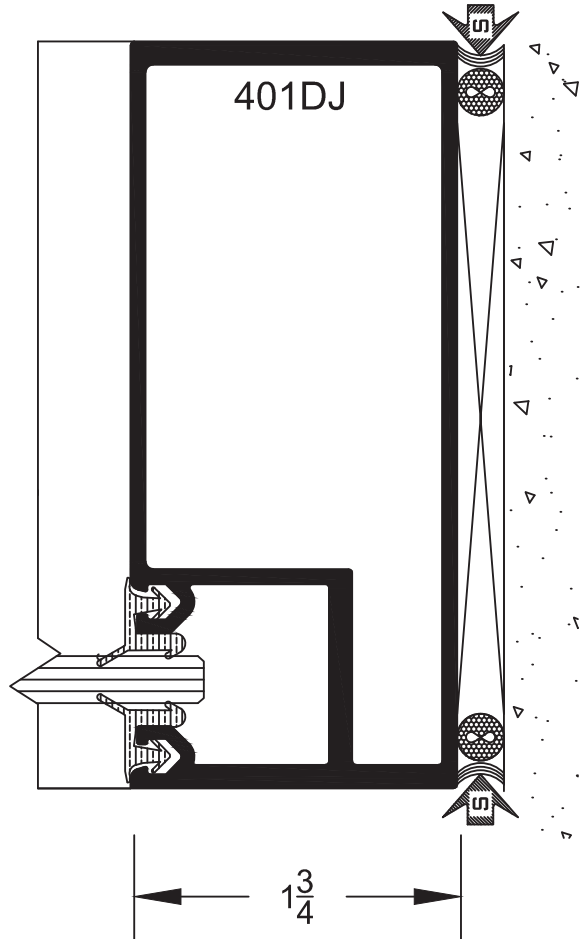
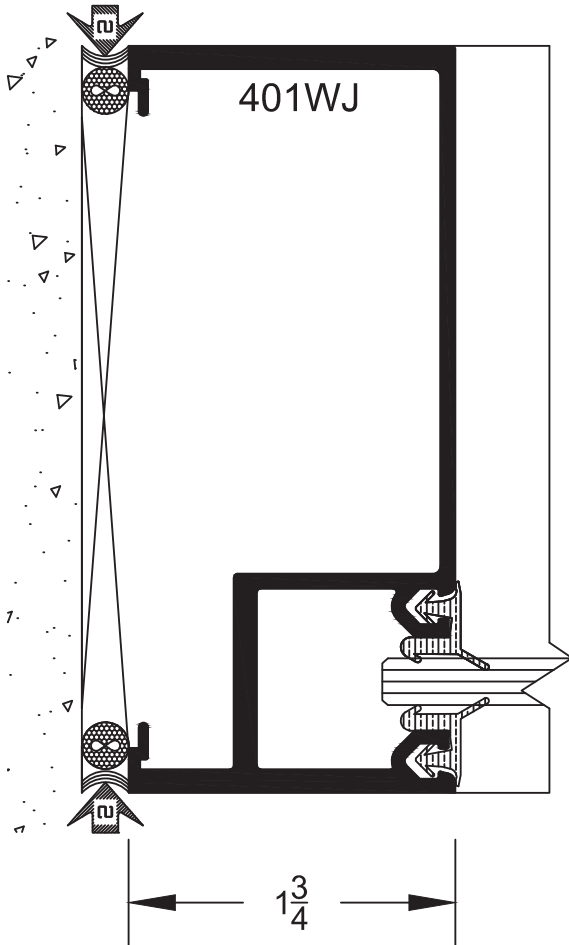

**PL-401 SERIES**  
**1-3/4" X 4"**  
**FULL SCALE**

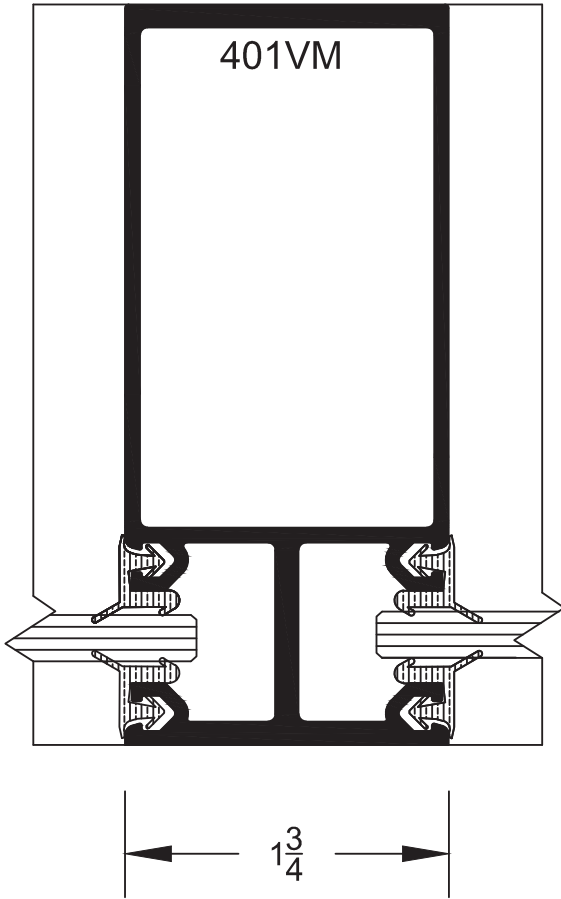

**B-1**

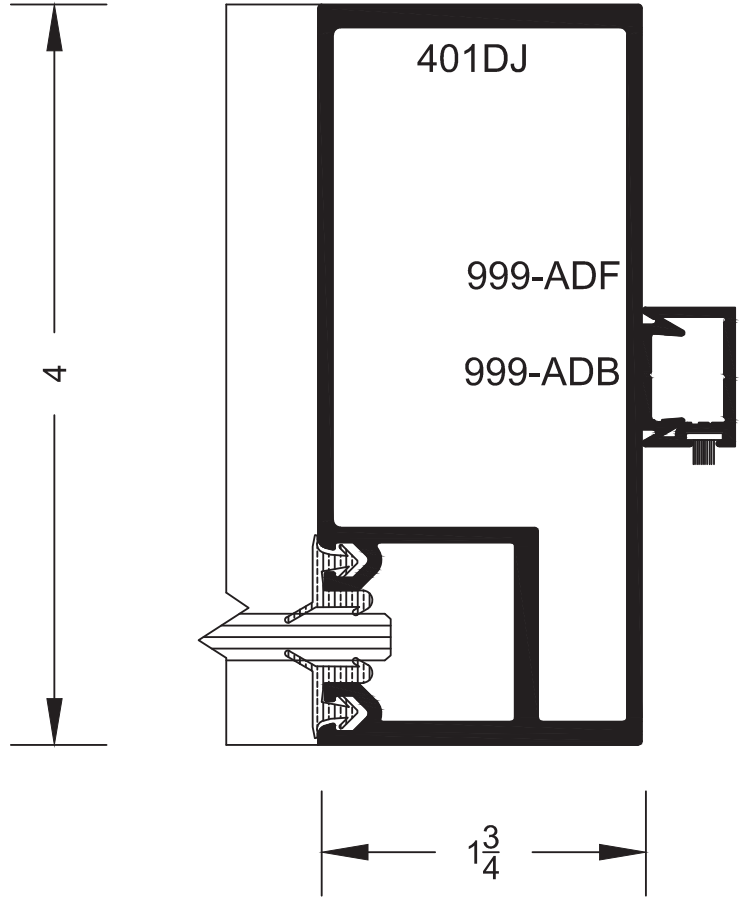

**G-1**

PL-401 SERIES  
1-3/4" X 4"  
FULL SCALE

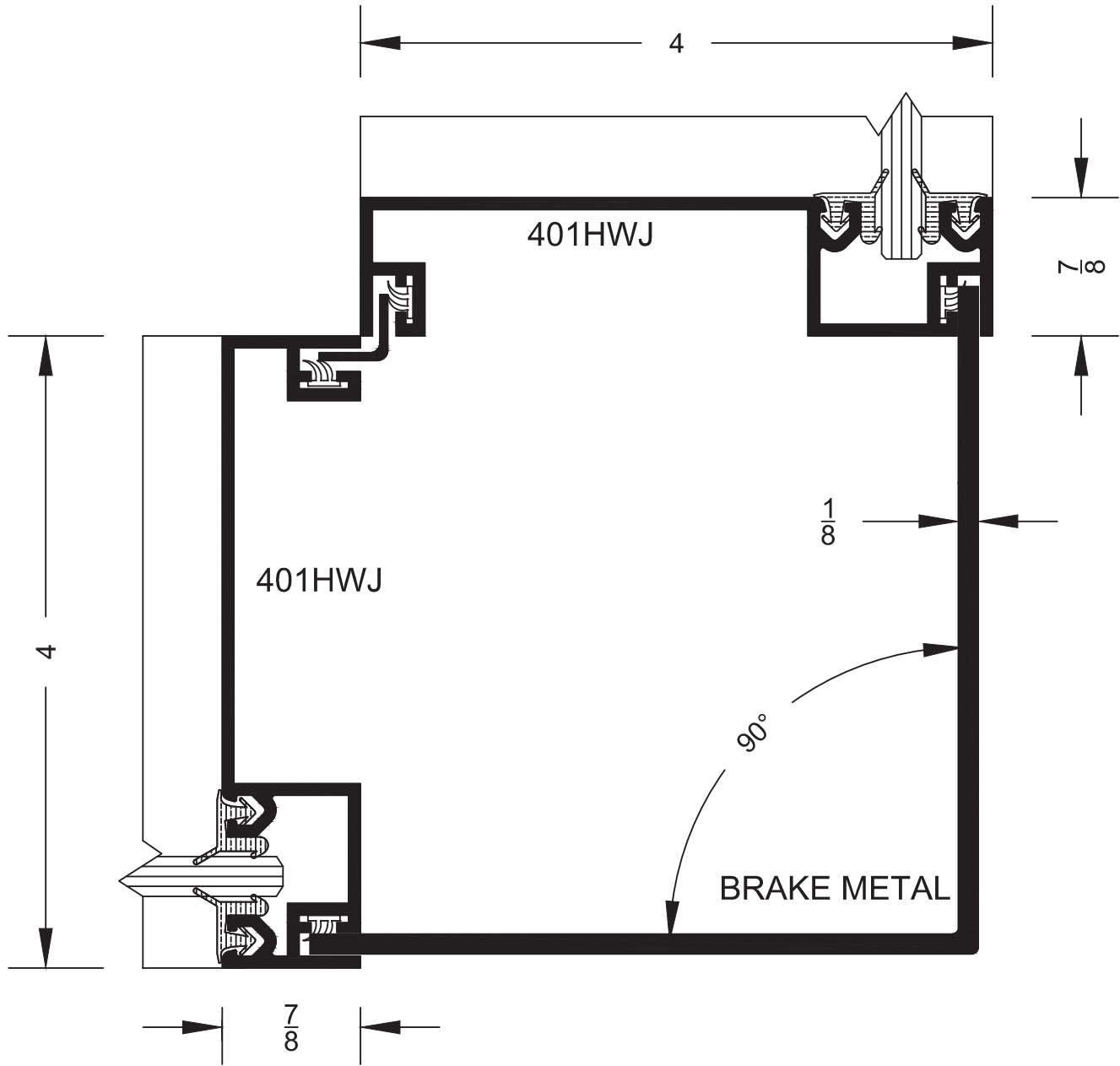

C-1

**PL-401 SERIES**  
**1-3/4" X 4"**  
**FULL SCALE**

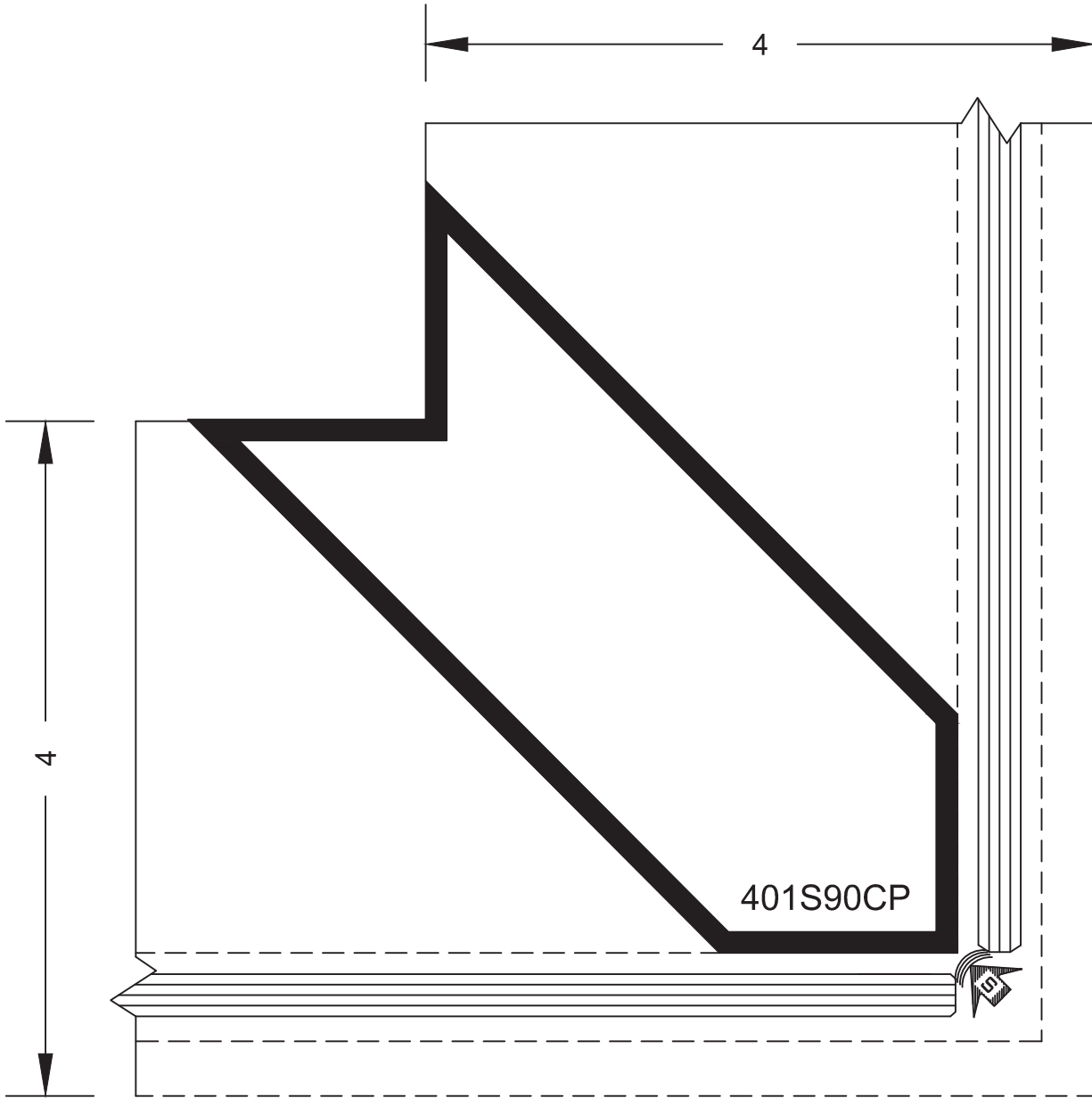

**C-2**

ph: (877) 775-2586  
fx: (877) 274-8800

**PL-401 - 10**  
14760 Don Julian Rd.  
Industry, CA 91746

[www.prlaluminum.com](http://www.prlaluminum.com)  
[sales@prlaluminum.com](mailto:sales@prlaluminum.com)

PL-401 SERIES  
1-3/4" X 4"  
FULL SCALE

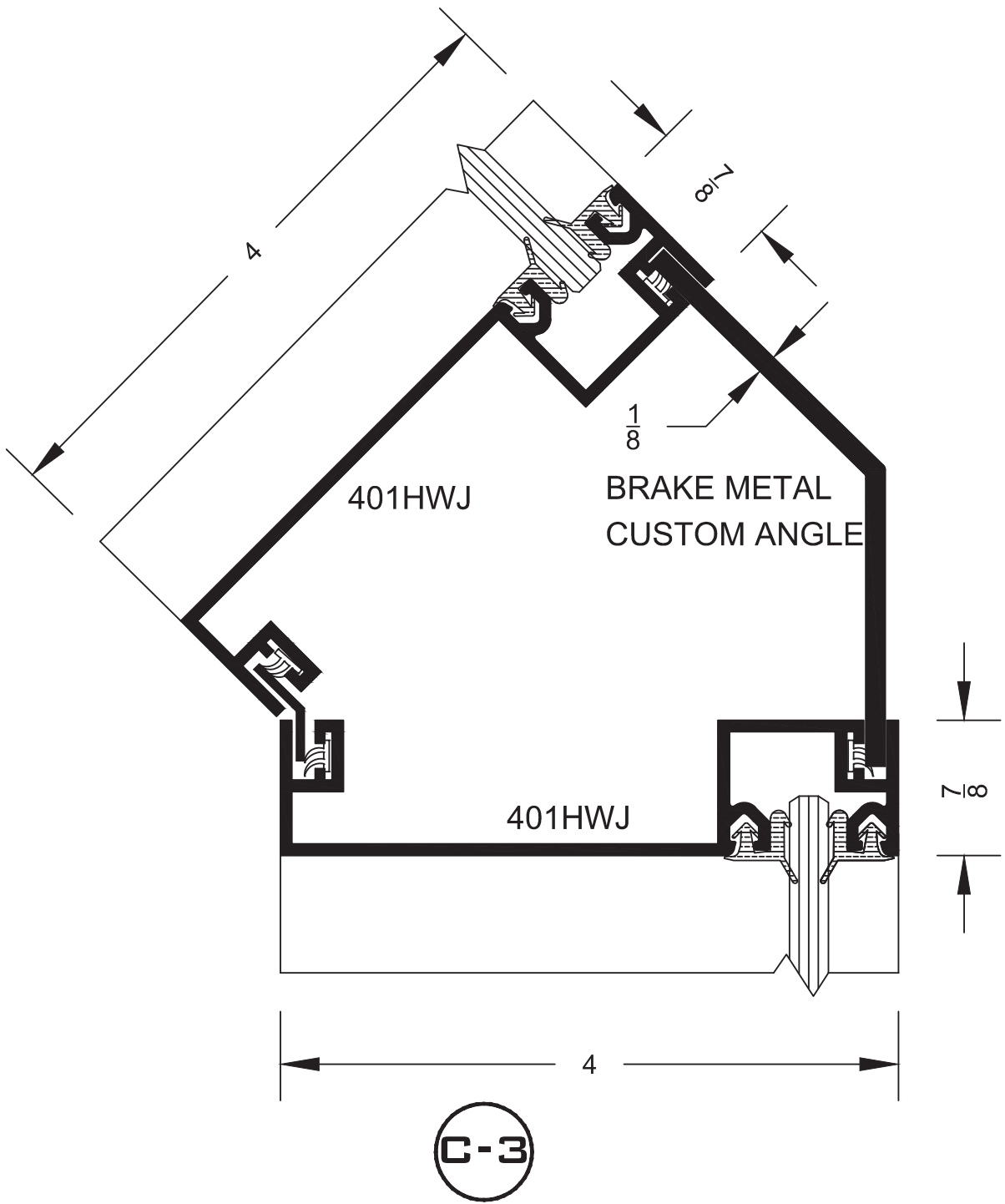

ph: (877) 775-2586  
fx: (877) 274-8800

PL-401 - 11  
14760 Don Julian Rd.  
Industry, CA 91746

www.prlaluminum.com  
sales@prlaluminum.com





## WIND LOAD DESIGN

GLAZING FRAMING SHALL BE DESIGNED NOT TO EXCEED L/175, RATIO CURVES SHALL REPRESENT LIMIT.

VALUES ARE BASED ON CRITERIA FOR SIMPLE BEAM UNIFORMLY LOADED.

ALLOWABLE STRESSES FOR 6063-T5 ALUMINUM ALLOY = 9500 P.S.I.  
ALLOWABLE STRESSES FOR A-36 STRUCTURAL STEEL = 21600 P.S.I.

MAXIMUM DEFLECTION BETWEEN SUPPORTS FOR SINGLE SPAN:

$$\Delta = \frac{5WL^3}{384EI}$$

MAXIMUM BENDING MOMENT FOR SINGLE SPAN:

$$M = \frac{WL}{8}$$

NOTATIONS REPRESENT:

W = TOTAL UNIFORM LOAD

L = LENGTH OF MULLION BETWEEN SUPPORTS

E =  $10 \times 10^6$  P.S.I.

I = MOMENT OF INERTIA OF MULLION

M = BENDING MOMENT

NOTE:

MULLIONS ARE ASSUMED TO HAVE EQUAL SIZE GLASS LIGHTS EACH SIDE

**401 VERTICAL MULLION**

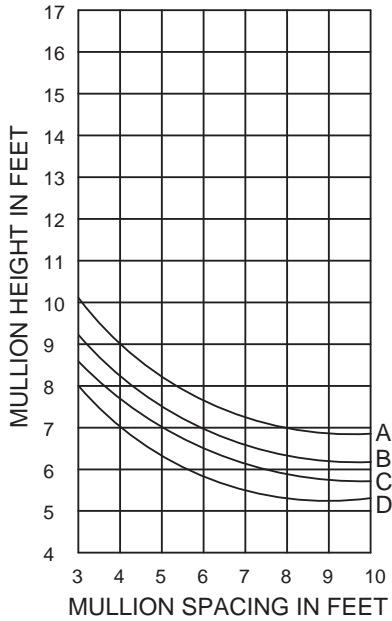

$I_{102} = 1.630 \text{ IN}^4$   
 $S_{102} = 0.815 \text{ IN}^3$



**401 DOOR JAMB**

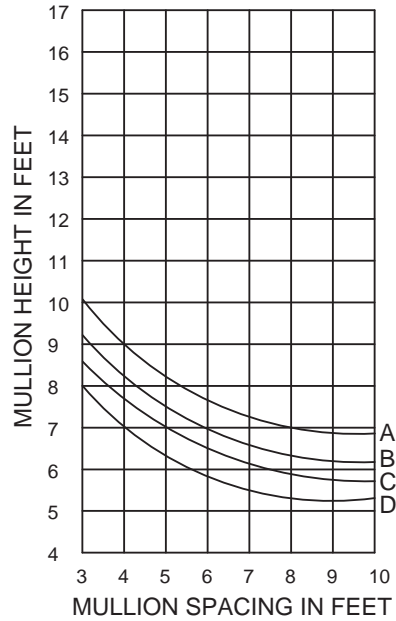

$I_{102} = 1.630 \text{ IN}^4$   
 $S_{102} = 0.815 \text{ IN}^3$

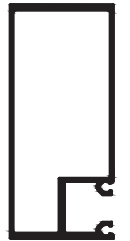

CURVE REPRESENTATION	
A	= 15 P.S.F. ( 75 M.P.H )
B	= 20 P.S.F. ( 90 M.P.H )
C	= 25 P.S.F. ( 100 M.P.H )
D	= 30 P.S.F. ( 110 M.P.H )

**401 VERTICAL WALL JAMB WITH STEEL REINFORCEMENT**

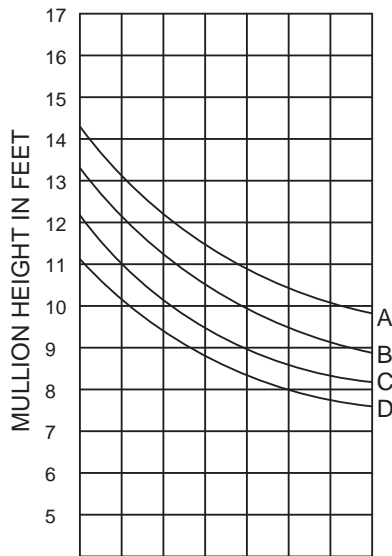

$I_{102/STL} = 4.642 \text{ IN}^4$   
 $S_{102/STL} = 1.672 \text{ IN}^3$

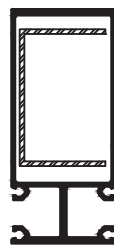

**401 VERTICAL WALL JAMB**

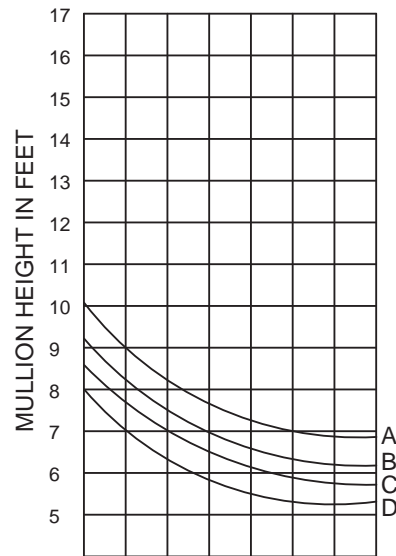

$I_{102} = 1.630 \text{ IN}^4$   
 $S_{102} = 0.815 \text{ IN}^3$



**450 SERIES**  
**1 3/4" x 4 1/2"**  
**SECTION**

**450 SERIES**  
**1 3/4" x 4 1/2"**  
**SECTION**

**ALUMINUM STOREFRONTS  
PL-450 SERIES**

**PART 1 GENERAL**

**1.1 SECTION INCLUDES**

- A. Aluminum storefronts.

**1.2 REFERENCES**

- A. ASTM International (ASTM):
  1. ASTM B 221 - Standard Specification for Aluminum and Aluminum-Alloy Extruded Bars, Rods, Wire, Profiles, and Tubes.
  2. ASTM E 283 - Test Method for Determining the Rate of Air Leakage Through Exterior Windows, Curtain Walls, and Doors under Specified Pressure Differences across the Specimen.
  3. ASTM E 330 - Standard Test Method for Structural Performance of Exterior Windows, Doors, Skylights and Curtain Walls by Uniform Static Air Pressure Difference.
  4. ASTM E 331 - Test Method for Water Penetration of Exterior Windows, Curtain Walls, and Doors by Uniform Static Air Pressure Difference.

**1.3 SUBMITTALS**

- A. Submit under provisions of applicable Requirements.
- B. Product Data: Manufacturer's data sheets on each product to be used, including:
  1. Preparation instructions and recommendations.
  2. Storage and handling requirements and recommendations.
  3. Installation methods.
- C. Shop Drawings: Configuration and details for installation, maintenance and operation.
- D. Selection Samples: For each finish product specified, two complete sets of color chips representing manufacturer's full range of available colors and patterns.
- E. Verification Samples: For each finish product specified, two samples, minimum size 6 inches (150 mm) square representing actual product, color, and patterns.

**1.4 QUALITY ASSURANCE**

- A. Manufacturer Qualifications: Minimum 5 year experience manufacturing similar products.
- B. Installer Qualifications: Minimum 2 year experience installing similar products.
- C. Mock-Up: Provide a mock-up for evaluation of surface preparation techniques and application workmanship.
  1. Finish areas designated by Architect.
  2. Do not proceed with remaining work until workmanship is approved by Architect.
  3. Refinish mock-up area as required to produce acceptable work.

**1.5 PRE-INSTALLATION MEETINGS**

**PL-450 - 1**

- A. Convene minimum two weeks prior to starting work of this section.

#### 1.6 DELIVERY, STORAGE, AND HANDLING

- A. Deliver and store products in manufacturer's unopened packaging bearing the brand name and manufacturer's identification until ready for installation.
- B. Handling: Handle materials to avoid damage.

#### 1.7 PROJECT CONDITIONS

- A. Maintain environmental conditions (temperature, humidity, and ventilation) within limits recommended by manufacturer for optimum results. Do not install products under environmental conditions outside manufacturer's recommended limits.

#### 1.8 SEQUENCING

- A. Ensure that products of this section are supplied to affected trades in time to prevent interruption of construction progress.

### **PART 2 PRODUCTS**

#### 2.1 MANUFACTURERS

- A. Acceptable Manufacturer: PRL Glass Systems, Inc., which is located at: 13644 Nelson Ave.; City of Industry, CA 91746; Toll Free Tel: 800-433-7044; Fax: 626-968-9256; Email: request; Web:[prlglass.com](http://prlglass.com)
- B. Substitutions: Not permitted.
- C. Requests for substitutions will be considered in accordance with provisions of Section 01 60 00 - Product Requirements.

#### 2.2 ALUMINUM STOREFRONT

- A. Product: Aluminum Storefront Series as manufactured by PRL Glass Systems, Inc.
- B. Design:
  - 1. Framing sections shall be extruded from 6063-T5 aluminum alloy.
  - 2. Glazing beads shall be NS (non-stretch, high-shore) vinyl used on both sides of the glass. Vinyl shall incorporate a fiberglass cord bonded with the vinyl.
  - 3. Sections shall conform to details and shall present clean, straight, sharply defined lines, and shall be free from defects impairing strength or durability.
  - 4. Screws, nuts, bolts and fastening devices and internal components shall be of aluminum, stainless steel or other non-corrosive material.
  - 5. Factory preparation from detail drawings shall be so fabricated that field assembly will be able to produce accurate, tightly fitted joints.
- C. **450-Series (1-3/4 X 4-1/2 Center Glaze for 1/4 Glazing):**
  - 1. Performance: (Test sample of 10 feet (3048 mm) wide by 10 feet (3048 mm) high - 3 lites wide by 2 lites high).
    - a. Air infiltration: Limit air leakage through fixed glazing and frames to 0.042 cfm/ft<sup>2</sup>/min when tested in accordance with ASTM E-283 at a cross pressure of 6.24 psf (0.30 kPa).
    - b. Water Penetration under Static Pressure: System shall not evidence uncontrolled water penetration at a cross pressure of 6 psf (0.29 kPa) when tested in accordance with ASTM-E331-00.
    - c. Uniform Load Structural per ASTM E 330: Limit deflection to L/175.

- 1) Passed at Design Pressure of 20 psf (0.96 kPa).

## **PART 3 EXECUTION**

### 3.1 EXAMINATION

- A. Do not begin installation until substrates have been properly prepared.
- B. If substrate preparation is the responsibility of another installer, notify Architect of unsatisfactory preparation before proceeding.

### 3.2 PREPARATION

- A. Clean surfaces thoroughly prior to installation.
- B. Prepare surfaces using the methods recommended by the manufacturer for achieving the best result for the substrate under the project conditions.

### 3.3 INSTALLATION

- A. Install in accordance with manufacturer's instructions.

### 3.4 FIELD QUALITY CONTROL

- A. All joints between metal and masonry shall be fully caulked and field tested to resist water leakage with provisions taken to drain infiltrated water.

### 3.5 PROTECTION

- A. Protect installed products until completion of project.
- B. Touch-up, repair or replace damaged products before Substantial Completion.

END OF SECTION





**PL-450 SERIES**  
**1-3/4 X 4-1/2**  
**1/4" CENTER GLAZED**

**PL-450 SERIES**  
 STOREFRONT MATERIAL



**SCREW RACE**

**QUICK SET**

**SCREW RACE**

**QUICK SET**

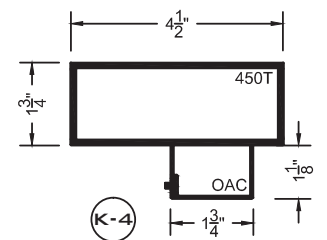
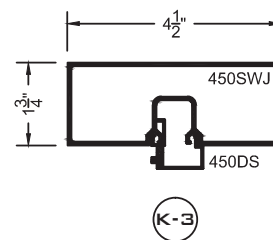
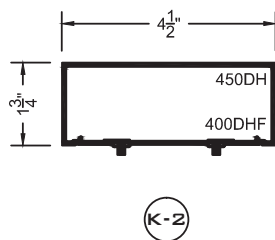
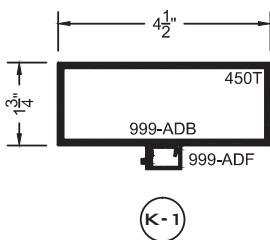
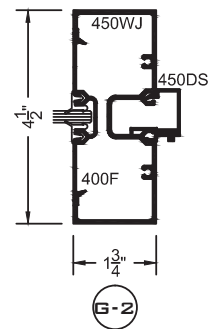
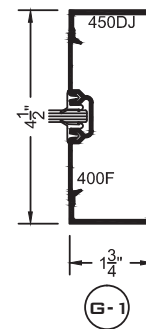
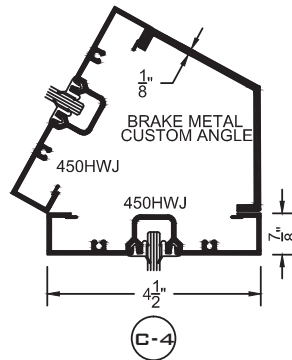
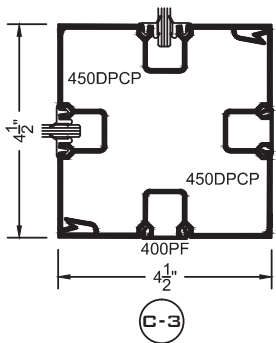
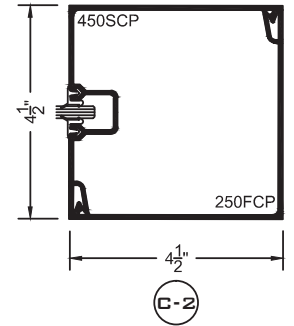
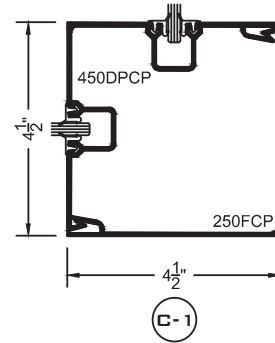
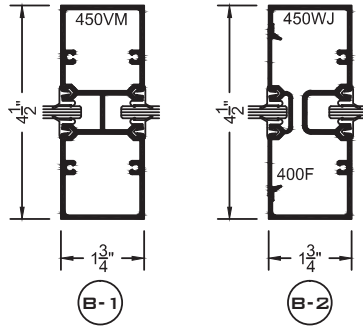
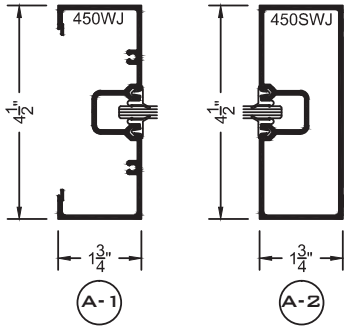
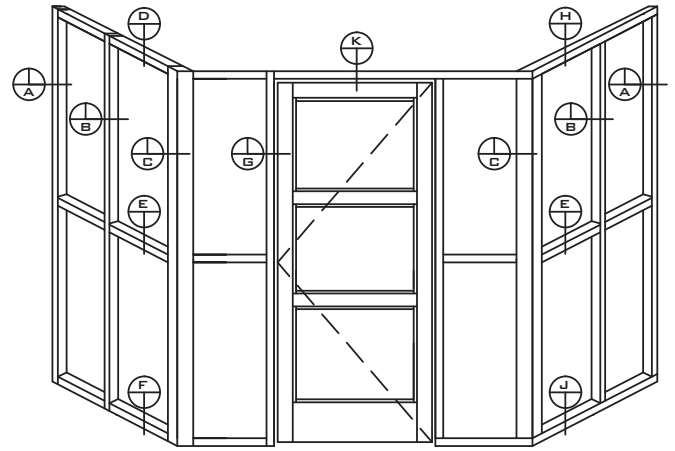
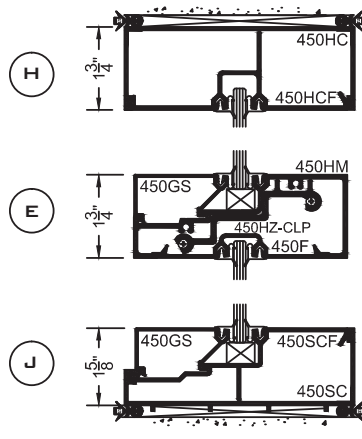
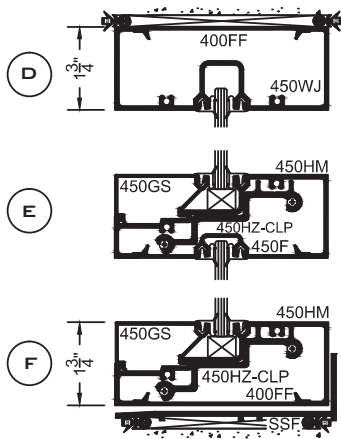

**PL-450 - 4**

ph: (877) 775-2586  
 fx: (877) 274-8800

14760 Don Julian Rd.  
 Industry, CA 91746

www.prlaluminum.com  
 sales@prlaluminum.com

**PL-450 SERIES**  
**1-3/4 X 4-1/2**  
**FULL SCALE**

**QUICK SET**



**H**

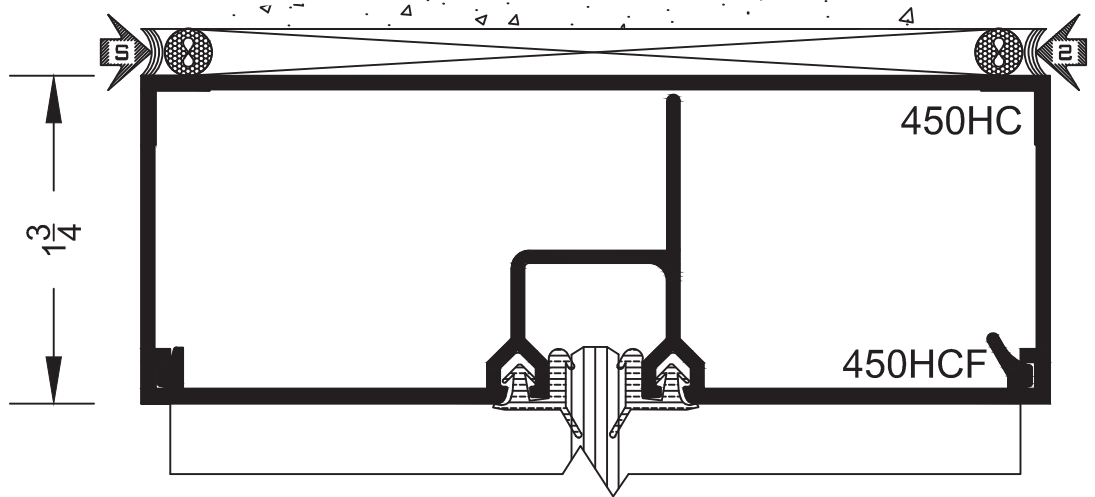

**F**

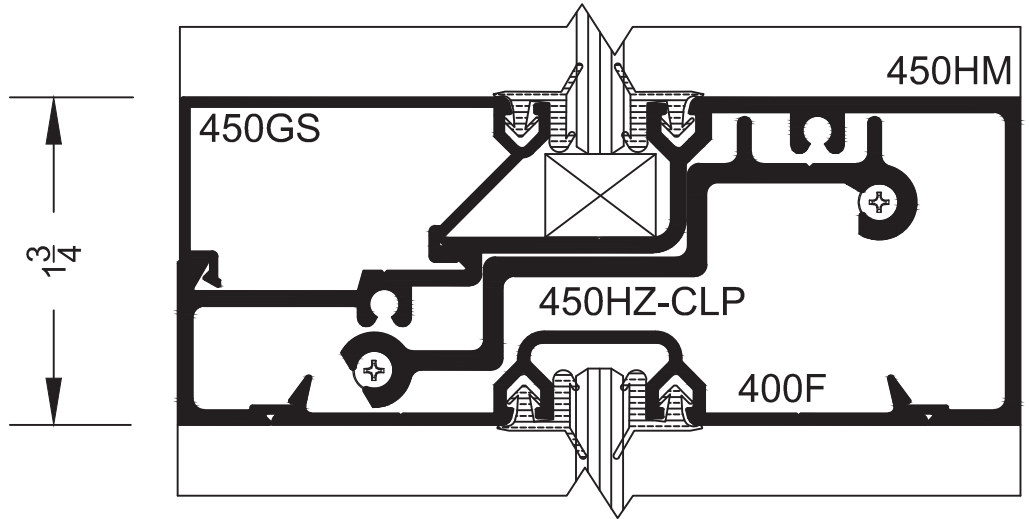

**J**

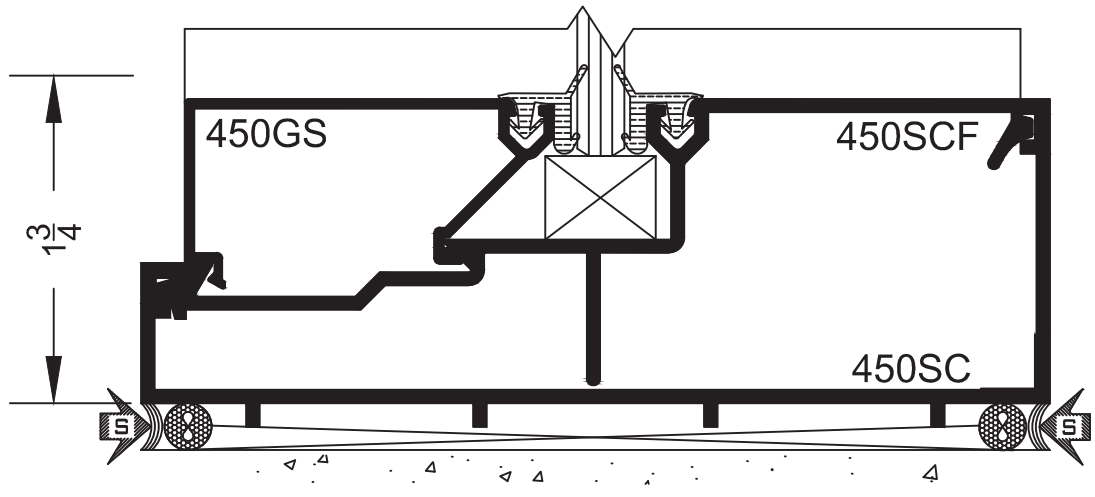

**PL-450 - 5**

14760 Don Julian Rd.  
 Industry, CA 91746

ph: (877) 775-2586  
 fx: (877) 274-8800

www.prlaluminum.com  
 sales@prlaluminum.com

**PL-450 SERIES**  
**1-3/4 X 4-1/2**  
**FULL SCALE**

**SCREW RACE**



**D**

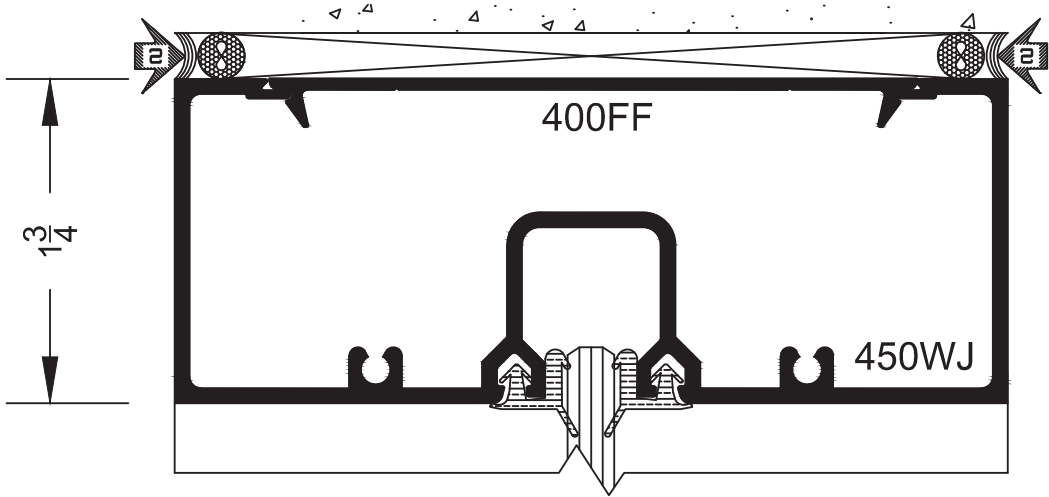

**E**

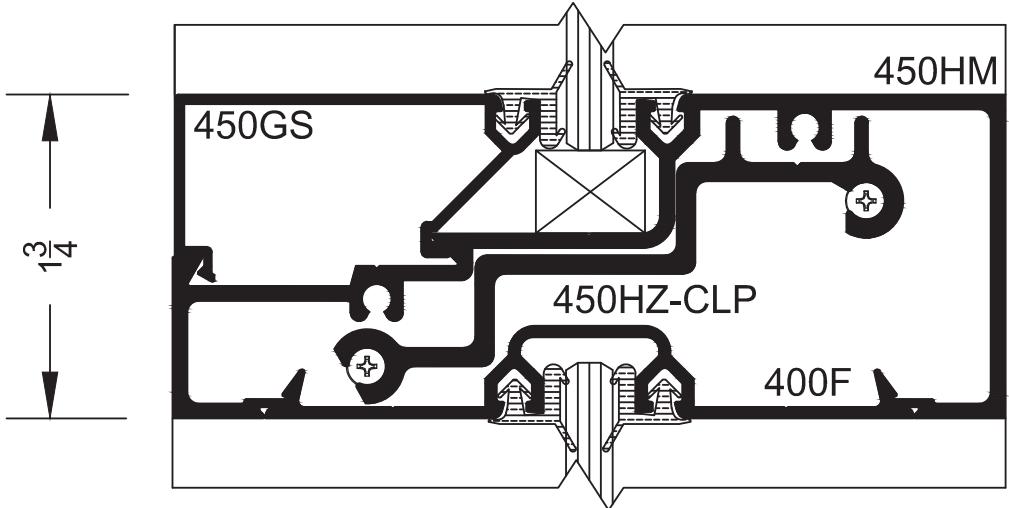

**F**

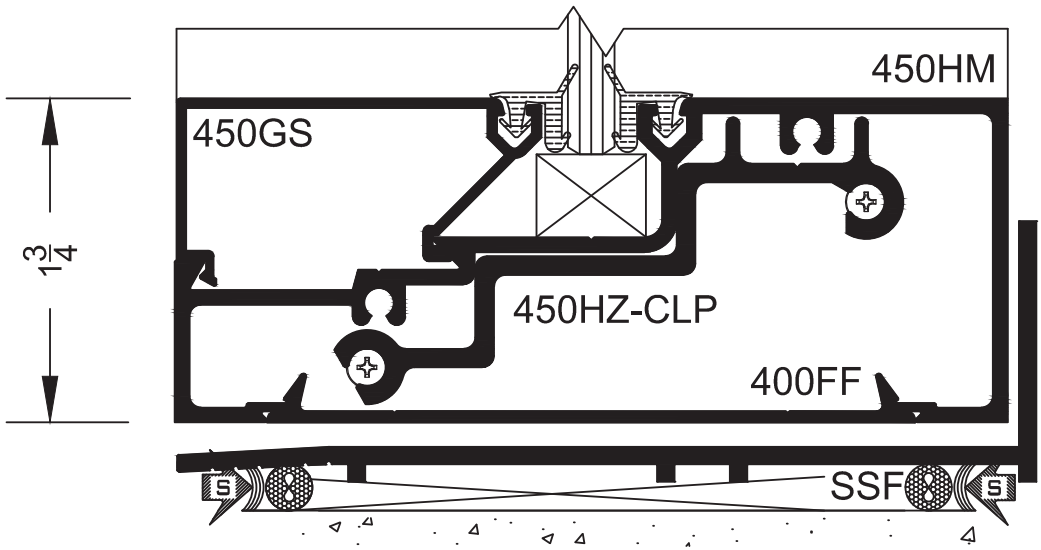

**PL-450 - 6**

ph: (877) 775-2586  
 fx: (877) 274-8800

14760 Don Julian Rd.  
 Industry, CA 91746

[www.prlaluminum.com](http://www.prlaluminum.com)  
[sales@prlaluminum.com](mailto:sales@prlaluminum.com)

**PL-450 SERIES**  
**1-3/4 X 4-1/2**  
**FULL SCALE**

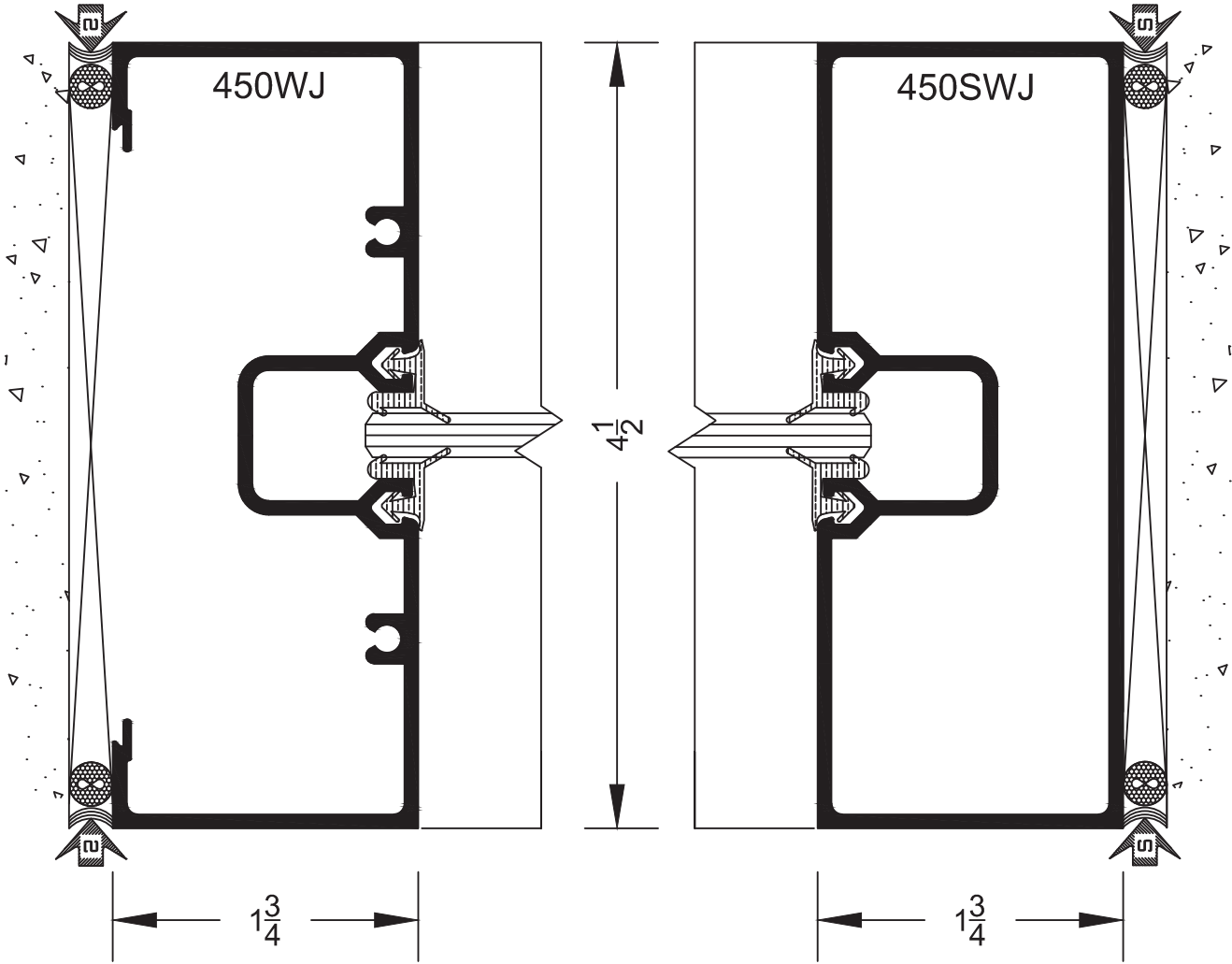

A-1

A-2

ph: (877) 775-2586  
fx: (877) 274-8800

**PL-450 - 7**  
14760 Don Julian Rd.  
Industry, CA 91746

[www.prlaluminum.com](http://www.prlaluminum.com)  
[sales@prlaluminum.com](mailto:sales@prlaluminum.com)

**PL-450 SERIES**  
**1-3/4 X 4-1/2**  
**FULL SCALE**

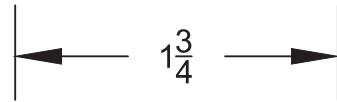
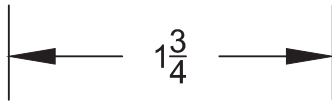
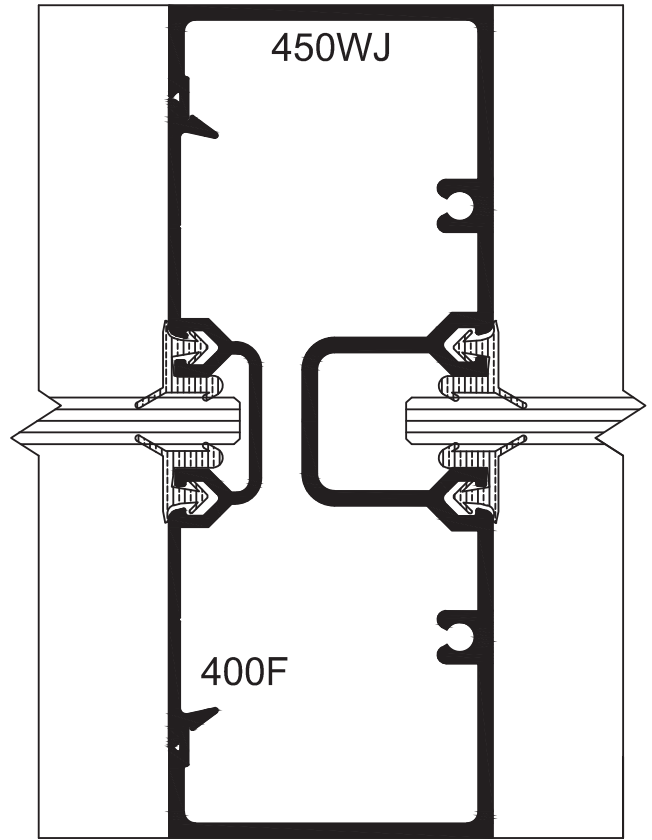
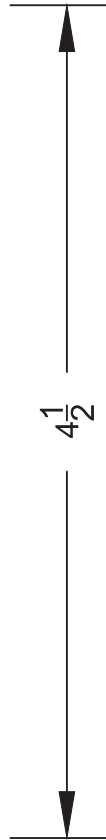
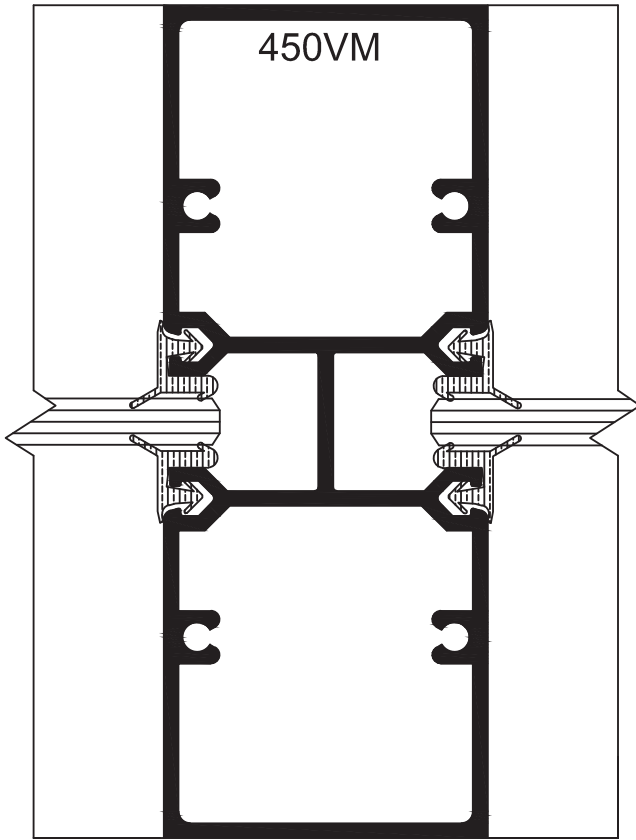

**B-1**

**B-2**

PL-450 SERIES  
1-3/4 X 4-1/2  
FULL SCALE

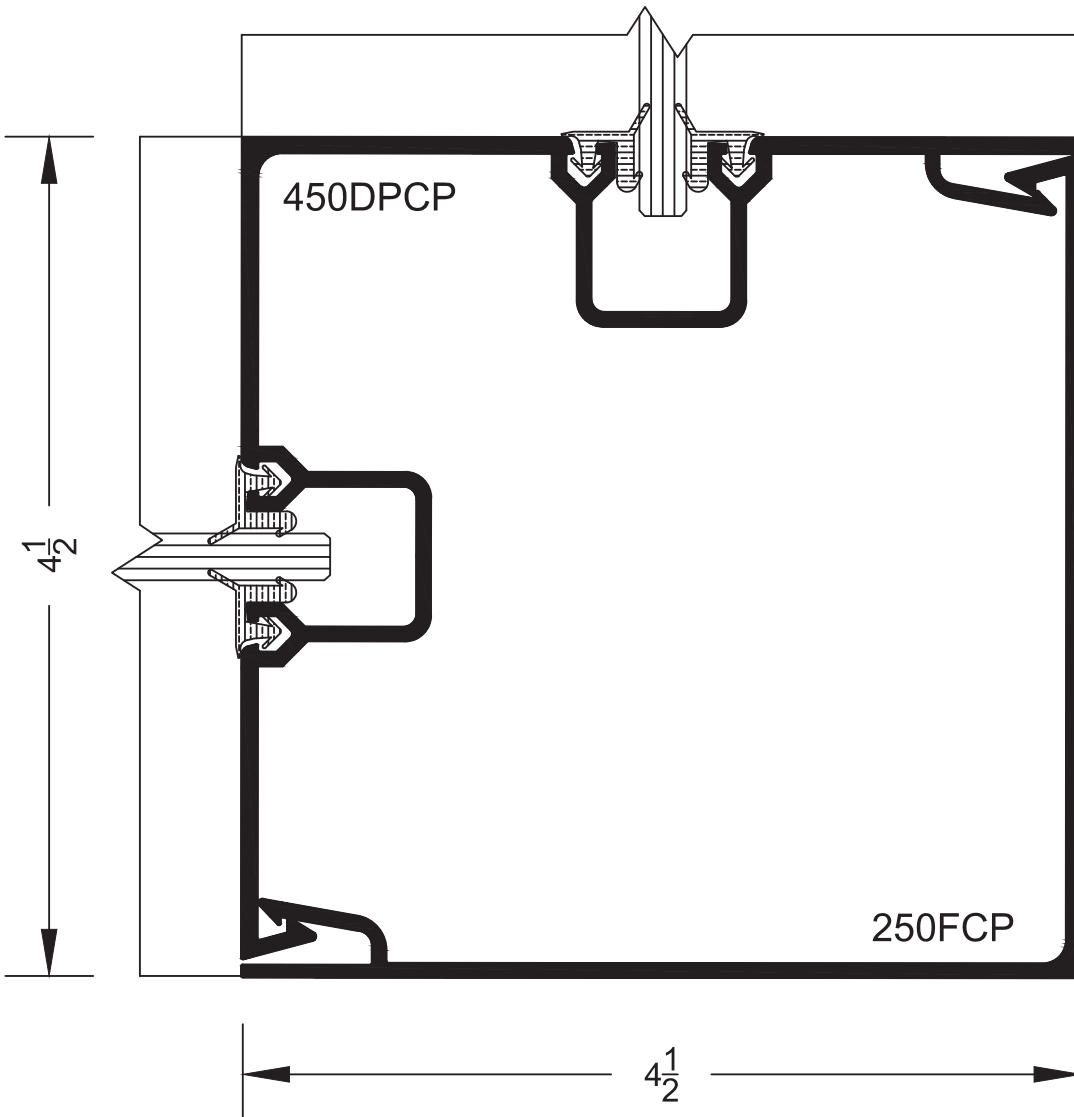

C-1

PL-450 SERIES  
1-3/4 X 4-1/2  
FULL SCALE

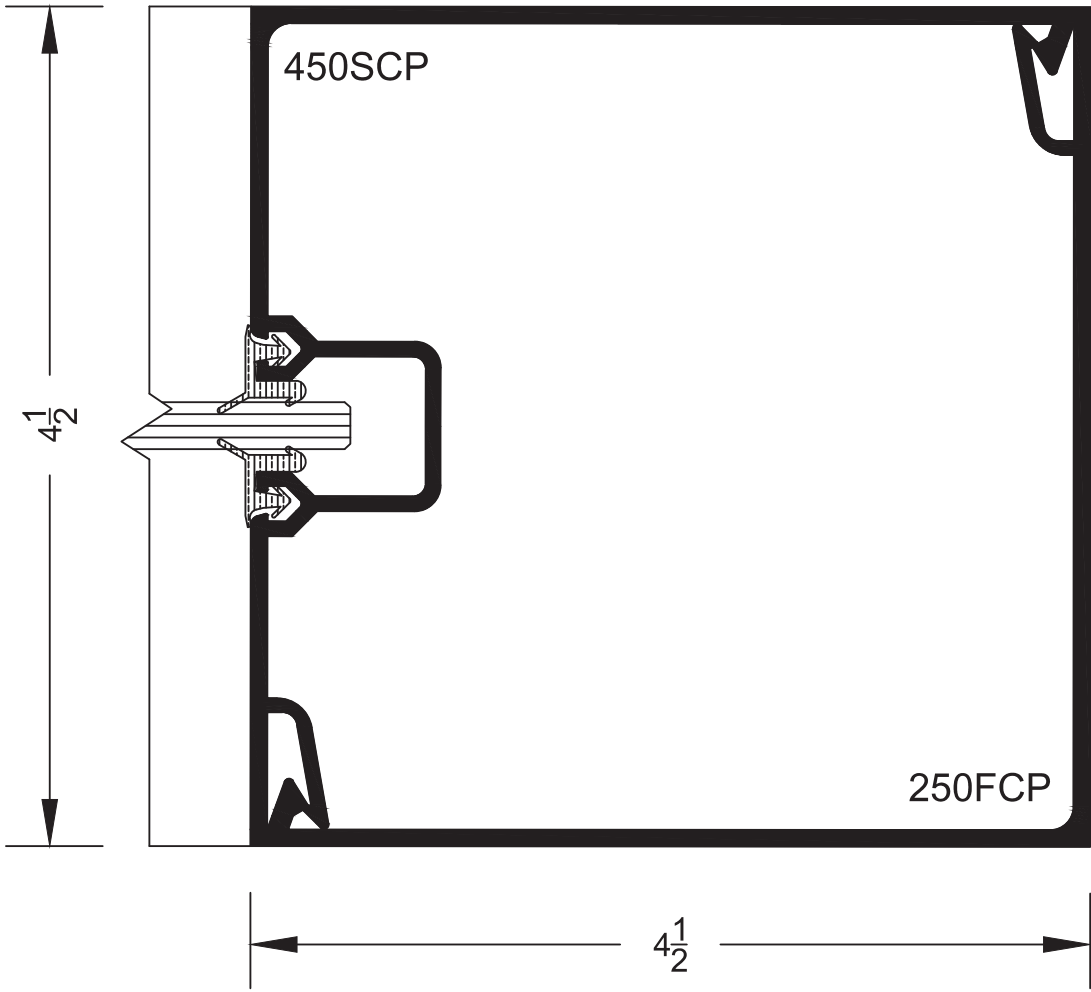

C-2

PL-450 SERIES  
1-3/4 X 4-1/2  
FULL SCALE

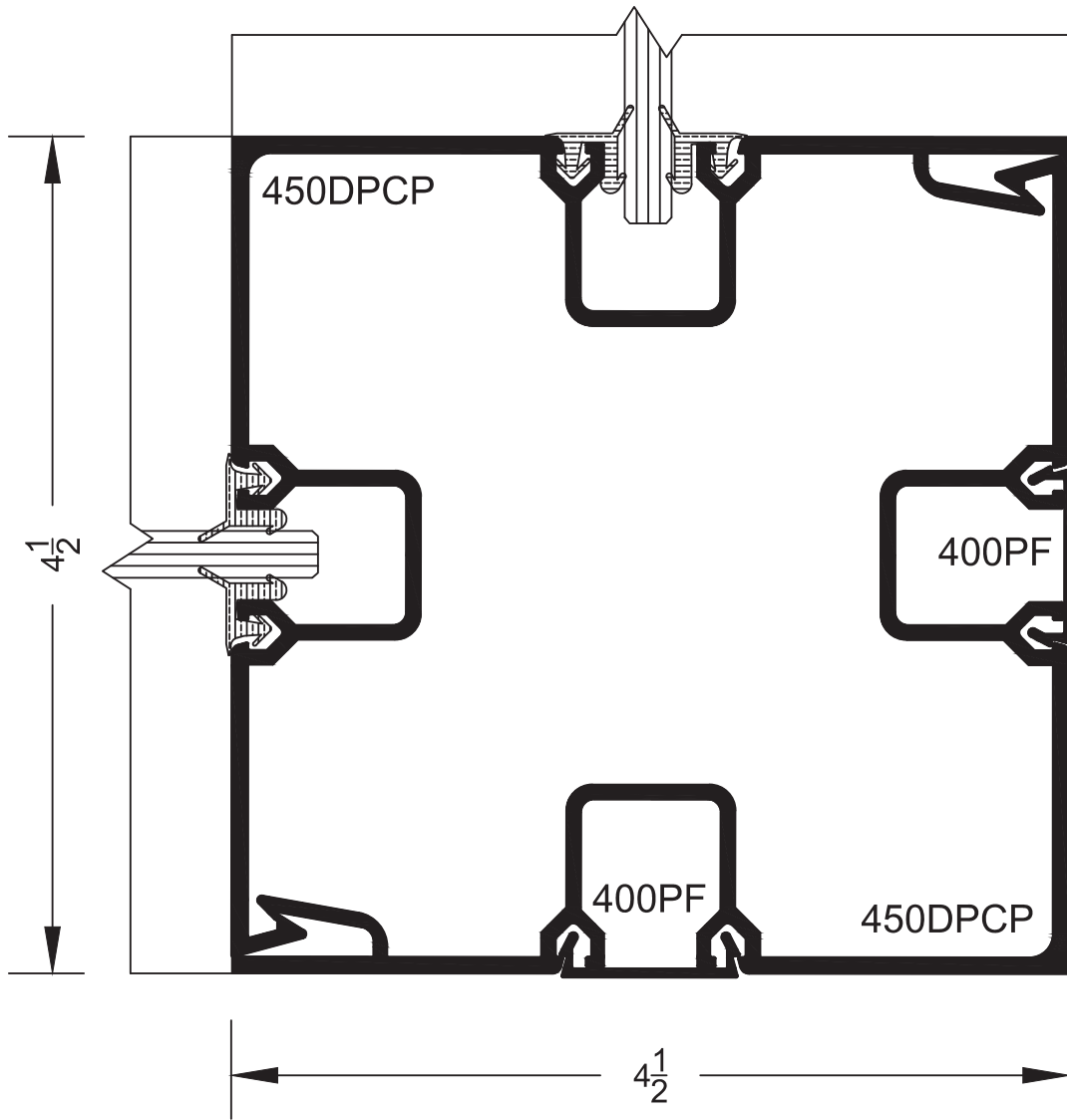

C-3



PL-450 SERIES  
1-3/4 X 4-1/2  
FULL SCALE

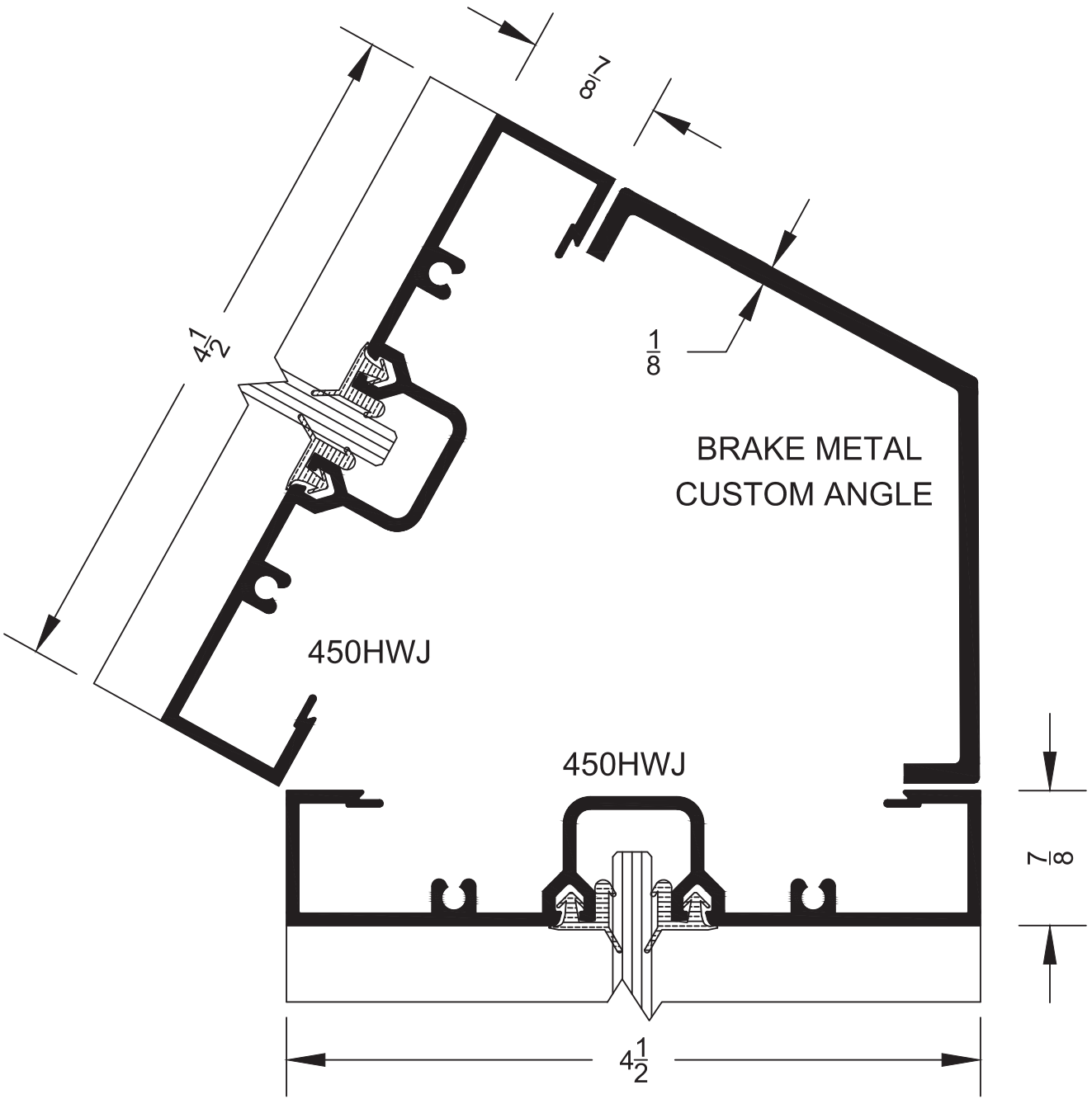

C-4

ph: (877) 775-2586  
fx: (877) 274-8800

PL-450 - 12  
14760 Don Julian Rd.  
Industry, CA 91746

www.prlaluminum.com  
sales@prlaluminum.com

**PL-450 SERIES**  
**1-3/4 X 4-1/2**  
**FULL SCALE**

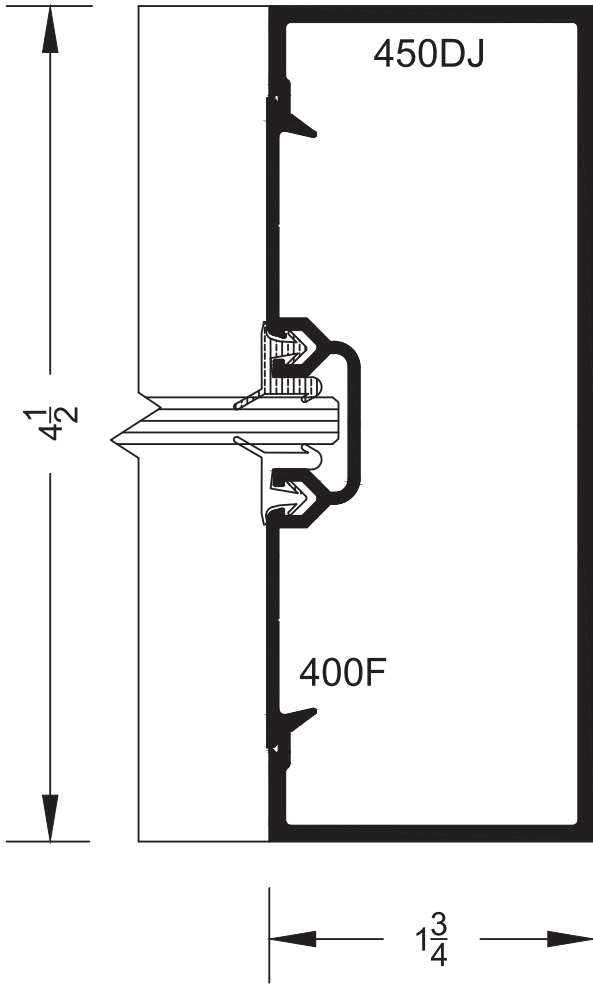

**G-1**

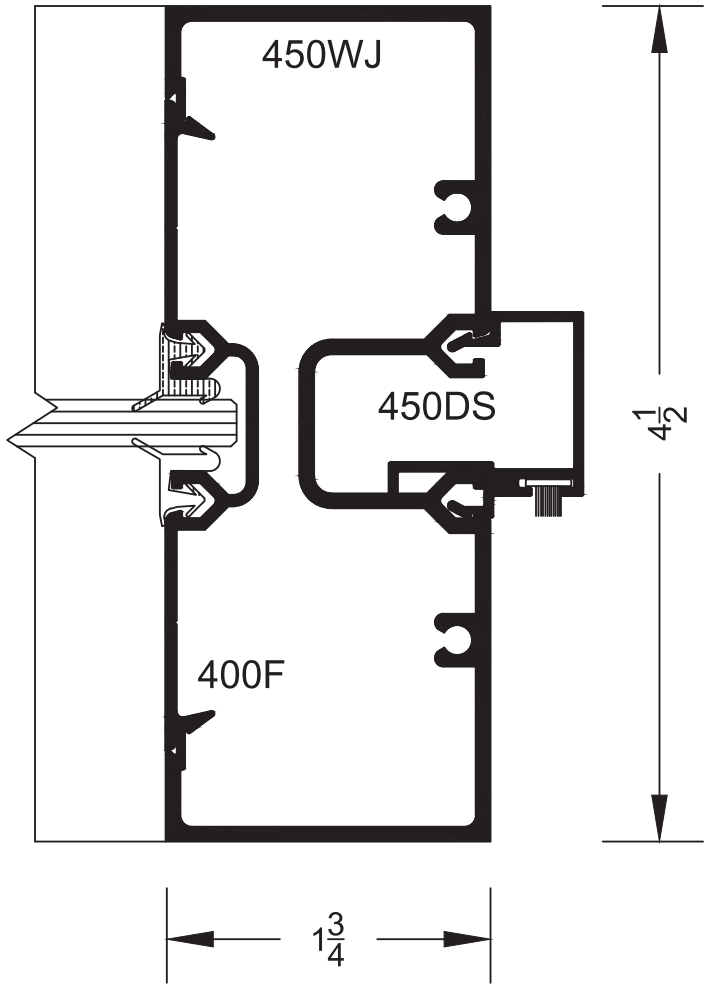

**G-2**

PL-450 SERIES  
1-3/4 X 4-1/2  
FULL SCALE



(K-1)

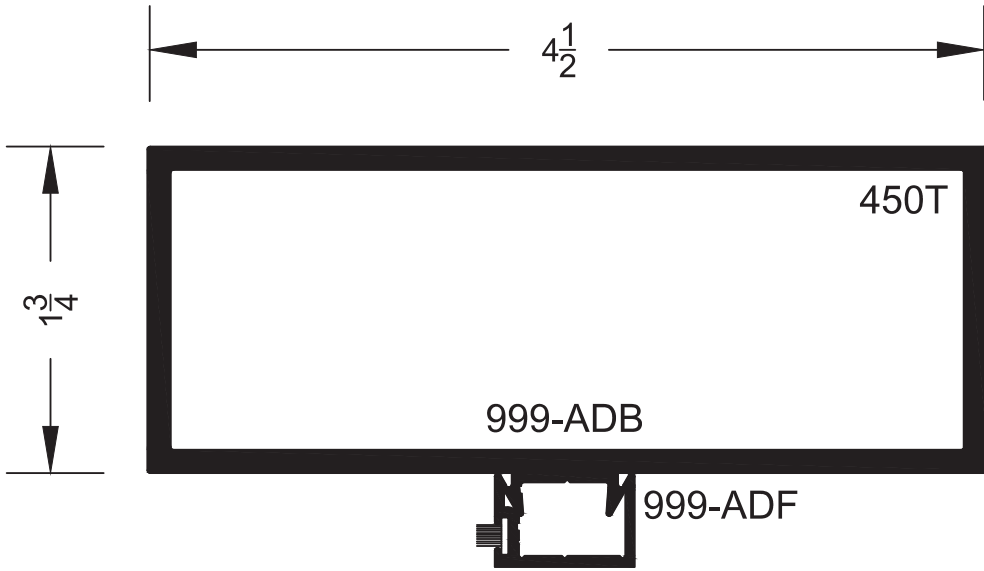

(K-2)

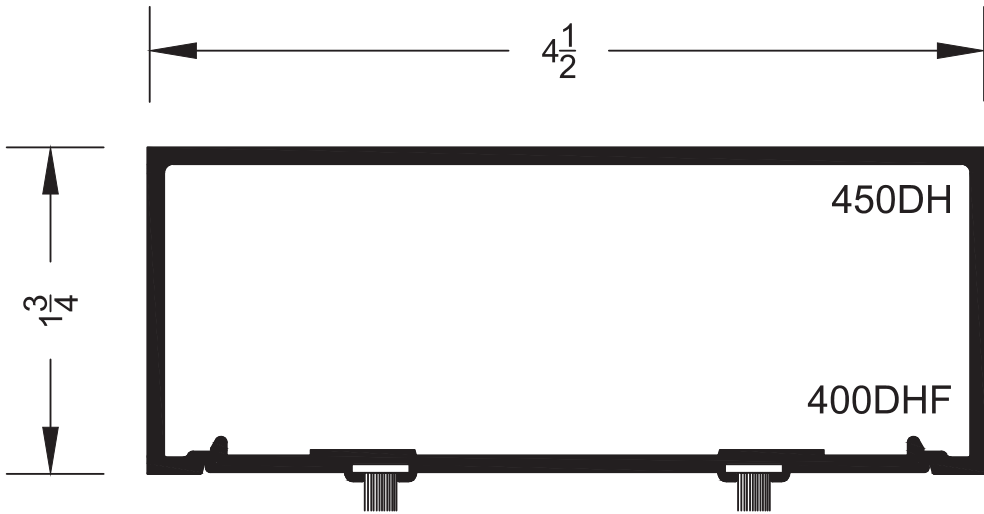

PL-450 SERIES  
1-3/4 X 4-1/2  
FULL SCALE



K-3

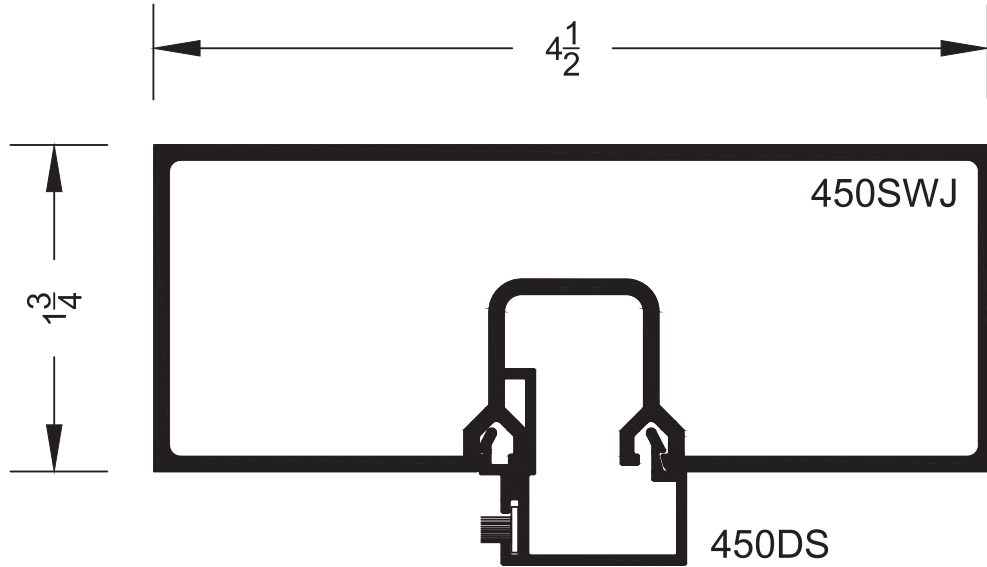

K-4

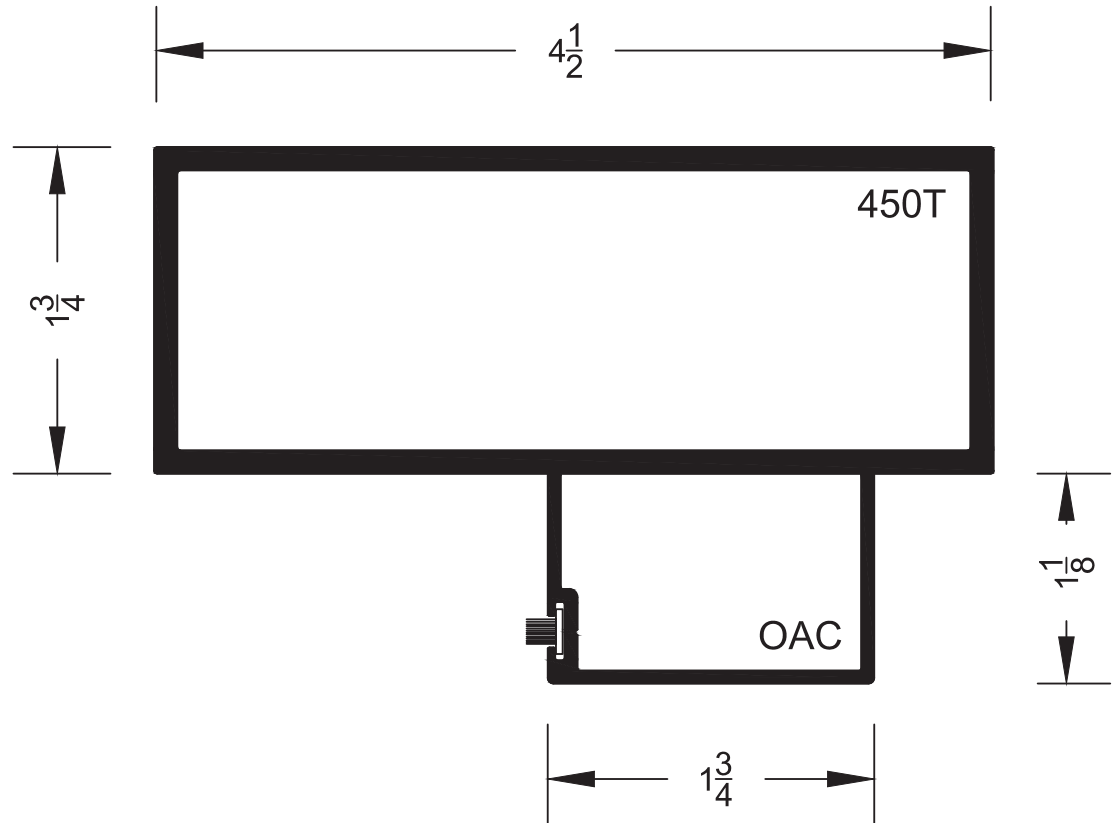

PL-450 - 15

ph: (877) 775-2586  
fx: (877) 274-8800

14760 Don Julian Rd.  
Industry, CA 91746

www.prlaluminum.com  
sales@prlaluminum.com



## WIND LOAD DESIGN

GLAZING FRAMING SHALL BE DESIGNED NOT TO EXCEED L/175, RATIO  
CURVES SHALL REPRESENT LIMIT.

VALUES ARE BASED ON CRITERIA FOR SIMPLE BEAM UNIFORMLY LOADED.

ALLOWABLE STRESSES FOR 6063-T5 ALUMINUM ALLOY = 9500 P.S.I.  
ALLOWABLE STRESSES FOR A-36 STRUCTURAL STEEL = 21600 P.S.I.

MAXIMUM DEFLECTION BETWEEN SUPPORTS FOR SINGLE SPAN:

$$\Delta = \frac{5WL^3}{384EI}$$

MAXIMUM BENDING MOMENT FOR SINGLE SPAN:

$$M = \frac{WL}{8}$$

NOTATIONS REPRESENT:

W = TOTAL UNIFORM LOAD

L = LENGTH OF MULLION BETWEEN SUPPORTS

E =  $10 \times 10^6$  P.S.I.

I = MOMENT OF INERTIA OF MULLION

M = BENDING MOMENT

NOTE:

MULLIONS ARE ASSUMED TO HAVE EQUAL SIZE GLASS LIGHTS EACH SIDE

**PL-450 SERIES**  
**1-3/4 X 4-1/2**  
**WIND LOAD**



450 WALL JAMB WITH FILLER

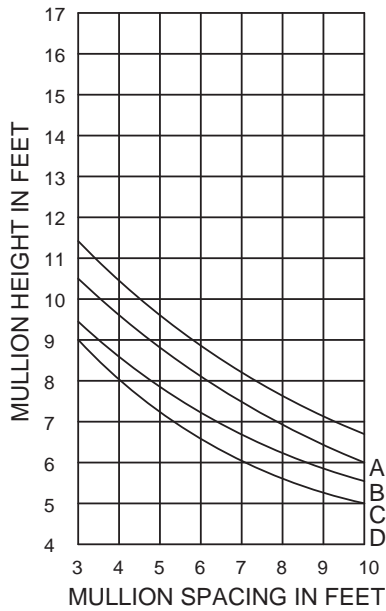

$I_{102} = 1.630 \text{ IN}^4$   
 $S_{102} = 0.815 \text{ IN}^3$



450 WALL JAMB WITH STEEL REINFORCEMENT

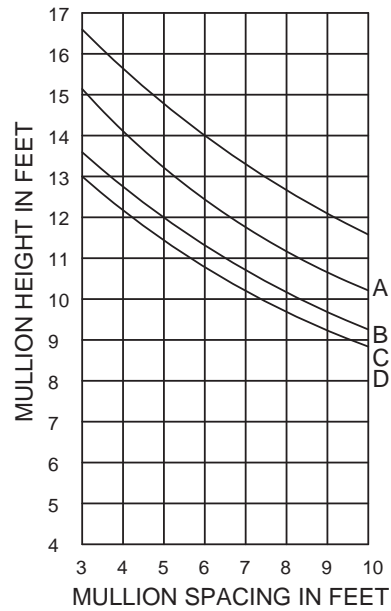

$I_{102/STL} = 4.642 \text{ IN}^4$   
 $S_{102/STL} = 1.672 \text{ IN}^3$

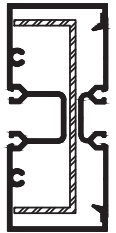

CURVE REPRESENTATION

- A = 15 P.S.F. ( 75 M.P.H )
- B = 20 P.S.F. ( 90 M.P.H )
- C = 25 P.S.F. ( 100 M.P.H )
- D = 30 P.S.F. ( 110 M.P.H )

450 TUBE

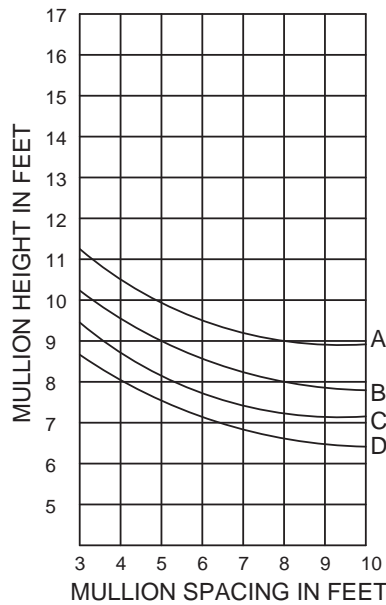

$I = 2.040 \text{ IN}^4$   
 $S = 1.20 \text{ IN}^3$

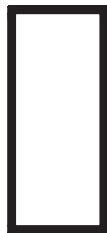

450 TUBE WITH STEEL REINFORCEMENT

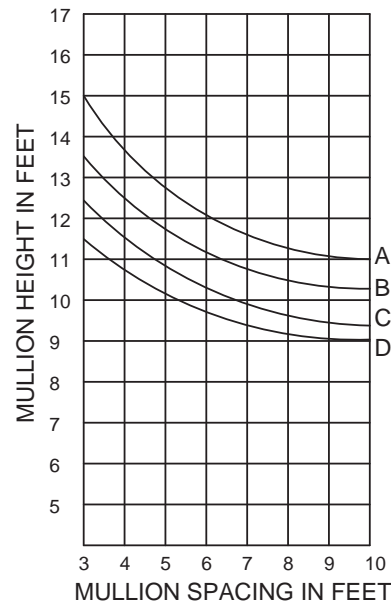

$I = 5.052 \text{ IN}^4$   
 $S = 2.526 \text{ IN}^3$

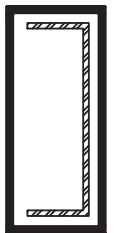

**PL-450 SERIES**  
**1-3/4 X 4-1/2**  
**WIND LOAD**



**450 WALL JAMB WITH FILLER**

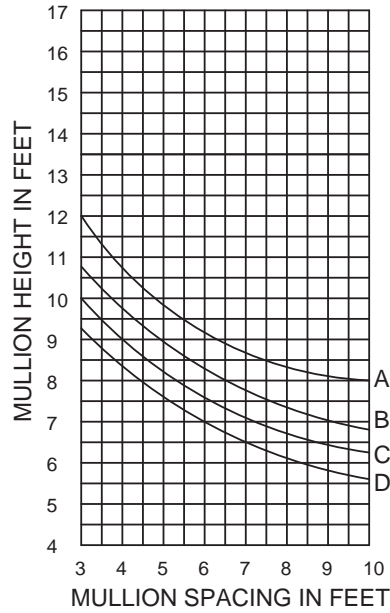

$I = 2.528 \text{ IN}^4$   
 $S = 1.124 \text{ IN}^3$



**CURVE REPRESENTATION**  
 A = 15 P.S.F. ( 75 M.P.H )  
 B = 20 P.S.F. ( 90 M.P.H )  
 C = 25 P.S.F. ( 100 M.P.H )  
 D = 30 P.S.F. ( 110 M.P.H )

**450 WALL JAMB WITH FILLER WITH STEEL REINFORCEMENT**

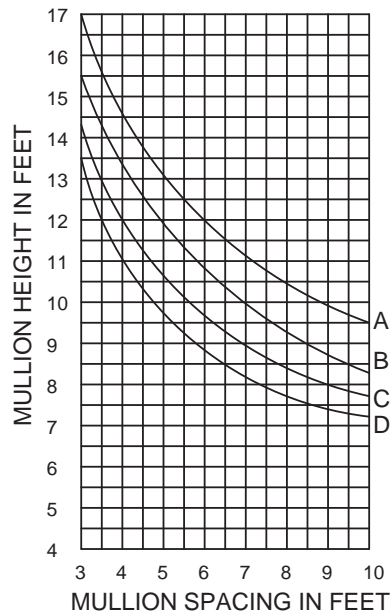

$I = 7.688 \text{ IN}^4$



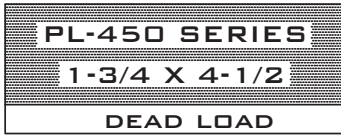

## DEAD LOAD DESIGN

GLAZING FRAMING SHALL BE DESIGNED NOT TO EXCEED L/360 OR 1/8" DEFLECTION WHICHEVER IS LES, RATIO CURVES SHALL REPRESENT LIMIT.

VALUES ARE BASED ON CRITERIA FOR SIMPLE BEAM UNIFORMLY LOADED.

ALLOWABLE STRESSES FOR 6063-T5 ALUMINUM ALLOY = 9500 P.S.I.  
ALLOWABLE STRESSES FOR A-36 STRUCTURAL STEEL = 21600 P.S.I.

MAXIMUM DEFLECTION BETWEEN SUPPORTS FOR SINGLE SPAN:

$$\Delta = \frac{Pa}{24EI} (3L^2 - 4a^2)$$

MAXIMUM BENDING MOMENT FOR SINGLE SPAN:

$$M = Pa$$

NOTATIONS REPRESENT:

P = 1/2 GLASS LOAD

a = 1/4 OR 1/8 POINT OF SPAN (INCHES)

E =  $10 \times 10^6$  P.S.I.

I = MOMENT OF INERTIA OF MULLION

L = LENGTH HORIZONTAL SPAN



**PL-450 SERIES**  
**1-3/4 X 4-1/2**  
**DEAD LOAD**



450 HORIZONTAL MULLION

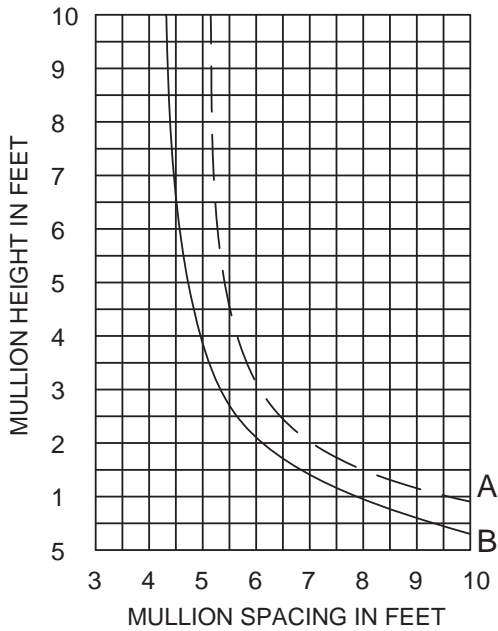

$I = 0.241 \text{ IN}^4$       MAX ALLOW DEFLECTION  $L/360$   
 $S = 0.250 \text{ IN}^3$       OR  $1/8"$  WHICHEVER IS LESS

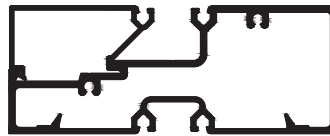

**CURVE REPRESENTATION**  
**(A) ( - - - - ) = 1/8 PTS. OR A MINIMUM OF 8" AWAY FROM THE EDGE OF GLASS**  
**(B) ( ——— ) = 1/4 PTS. A MINIMUM OF 8" AWAY FROM THE EDGE OF GLASS**



# **PLCW-600 SERIES**

**2 1/2" x 6"**

**SECTION**

# **PLCW-600 SERIES**

**2 1/2" x 6"**

**SECTION**



## ALUMINUM CURTAIN WALLS PLCW-600 SERIES

### **PART 1 GENERAL**

#### 1.1 SECTION INCLUDES

- A. Aluminum curtain walls.

#### 1.2 REFERENCES

- A. American Architectural Manufacturers Association (AAMA):
  1. AAMA/NWWDA 101/I.S. 2-97 - Voluntary Specification, Performance Requirements and Test Procedures for Air Leakage Resistance, Water Penetration Resistance, Structural Loading, Forced Entry Resistance.
  2. AAMA-501.1 - Standard Test Method for Water Penetration of Windows, Curtain Walls and Doors Using Dynamic Pressure
  3. AAMA 501.4 - Recommended Static Test Method for Evaluating Curtain Wall and Storefront Systems Subjected to Seismic and Wind Induced Interstory Drifts.
  4. AAMA 2605 - Voluntary Specification, Performance Requirements and Test Procedures for Superior Performing Organic Coatings on Aluminum Extrusions and Panels.
- B. ASTM International (ASTM):
  1. ASTM B 221 - Standard Specification for Aluminum and Aluminum-Alloy Extruded Bars, Rods, Wire, Profiles, and Tubes.
  2. ASTM E 283 - Test Method for Determining the Rate of Air Leakage Through Exterior Windows, Curtain Walls, and Doors under Specified Pressure Differences across the Specimen.
  3. ASTM E330 - Standard Test Method for Structural Performance of Exterior Windows, Doors, Skylights and Curtain Walls by Uniform Static Air Pressure Difference.
  4. ASTM E 331 - Test Method for Water Penetration of Exterior Windows, Curtain Walls, and Doors by Uniform Static Air Pressure Difference.
  5. ASTM E 1886 - Standard Test Method for Performance of Exterior Windows, Curtain Walls, Doors, and Impact Protective Systems Impacted by Missile(s) and Exposed to Cyclic Pressure Differentials.
  6. ASTM E 1996 - Standard Specification for Performance of Exterior Windows, Curtain Walls, Doors and Impact Protective Systems Impacted by Windborne Debris in Hurricanes.
- C. National Fenestration Rating Council (NFRC):
  1. NFRC-100 - Procedure for Determining Fenestration Product U-factors.
  2. NFRC-200 - Procedure for Determining Fenestration Product Solar Heat Gain Coefficient and Visible Transmittance at Normal Incidence.

#### 1.3 SUBMITTALS

- A. Submit under provisions of applicable Requirements.
- B. Product Data: Manufacturer's data sheets on each product to be used, including:
  1. Preparation instructions and recommendations.
  2. Storage and handling requirements and recommendations.

### **PLCW-600 - 1**

- 3. Installation methods.
  - C. Shop Drawings:
    - 1. Provide drawings showing each configuration.
  - D. Selection Samples: For each finish product specified, two complete sets of color chips representing manufacturer's full range of available colors and patterns.
  - E. Verification Samples: For each finish product specified, two samples, minimum size 6 inches (150 mm) square representing actual product, color, and patterns.
- 1.4 QUALITY ASSURANCE
- A. Manufacturer Qualifications: Minimum 5 year experience manufacturing similar products.
  - B. Installer Qualifications: Minimum 2 year experience installing similar products.
  - C. Mock-Up: Provide a mock-up for evaluation of surface preparation techniques and application workmanship.
    - 1. Finish areas designated by Architect.
    - 2. Do not proceed with remaining work until workmanship is approved by Architect.
    - 3. Refinish mock-up area as required to produce acceptable work.
- 1.5 PRE-INSTALLATION MEETINGS
- A. Convene minimum two weeks prior to starting work of this section.
- 1.6 DELIVERY, STORAGE, AND HANDLING
- A. Deliver and store products in manufacturer's unopened packaging bearing the brand name and manufacturer's identification until ready for installation.
  - B. Handling: Handle materials to avoid damage.
- 1.7 PROJECT CONDITIONS
- A. Maintain environmental conditions (temperature, humidity, and ventilation) within limits recommended by manufacturer for optimum results. Do not install products under environmental conditions outside manufacturer's recommended limits.
- 1.8 SEQUENCING
- A. Ensure that products of this section are supplied to affected trades in time to prevent interruption of construction progress.

## **PART 2 PRODUCTS**

- A. Acceptable Manufacturer: PRL Glass Systems, Inc., which is located at: 13644 Nelson Ave.; City of Industry, CA 91746; Toll Free Tel: 800-433-7044; Fax: 626-968-9256; Email:[request info \(info@prlglass.com\)](mailto:requestinfo@prlglass.com); Web:[prlglass.com](http://prlglass.com)
  - B. Substitutions: Not permitted.
  - C. Requests for substitutions will be considered in accordance with provisions of Section 01 60 00 - Product Requirements.
- 2.2 CURTAIN WALLS

- A. Frame : 2-1/2 inches (64 mm) face width:
  - 1. Glazing: Structural glaze verticals.
  - 2. Glazing: Structural glaze horizontals.
  
- B. **6 Inches (152 mm) Depth:**
  - 1. **Product: PLCW-600 as manufactured by PRL Glass Systems, Inc.**
  - 2. Performance:
    - a. Air infiltration: Limit air leakage through fixed glazing and frames to 0.026 cfm/ft<sup>2</sup>/min (0.01 L/s/m<sup>2</sup>) when tested in accordance with ASTM E-283-04 at a cross pressure of 6.24 psf (0.30 kPa).
    - b. Water Penetration under Static Pressure: System shall not evidence uncontrolled water penetration at a cross pressure of 15 psf (103 kPa) when tested in accordance with ASTM-E331-00.
    - c. Water Penetration under Dynamic Pressure: System shall not evidence uncontrolled water penetration at a cross pressure of 15 psf (103 kPa) when tested in accordance with AAMA-501.1-05.
    - d. Design Wind Load: Limit mullion deflection to L/175 up to 13 feet-6 inches (4115 mm) and L/240+1/4 inch (6 mm) for spans above 13 feet-6 inches (4115 mm) when measured in accordance with ASTM E330-02 at a cross pressure of 40 psf (276 kPa).
    - e. Seismic Racking: Compliance that system can accommodate a lateral movement of 3/4 inch (19 mm) when tested to AAMA 501.4-00.
    - f. Thermal Conductance: Whole product rating shall be determined in accordance with NFRC-100. Show that specified product can achieve U-factor of no greater than 0.37 (Values based on structural glaze verticals, and insulated glass comprising exterior light of 1/4 inch (6 mm) bronze, 1/2 inch (13 mm) space with argon fill and an interior light of 1/4 inch (6 mm) SunGuard SNX 62/27).
    - g. Solar Heat Gain: Whole product rating shall be determined in accordance with NFRC-200. Show that the specified product can achieve a SHGC of no greater than 0.36. (Values based on structural glaze verticals, and insulated glass comprising exterior light of 1/4 inch (6 mm) bronze, 1/2 inch (13 mm) space with argon fill and an interior light of 1/4 inch (6 mm) SunGuard SNX 62/27).
    - h. Large Missile Impact: Design and fabrication shall meet the performance requirements in the referenced test procedures for a +1676/-2873 Pa (+35/-60 psf) design pressure with missile impacts corresponding to Missile Level D and Wind Zone 3 for a Basic Protection Rating. (Laminated I.G. 1-1/8 inches (29 mm) I.G. Marine glazed into a rubber glazing gasket.

## 2.3 MATERIALS

- A. Material: Frames, assembly clips, trims and miscellaneous extrusions shall be extruded from Aluminum 6063-T6 alloy.
  
- B. Glazing Gaskets:
  - 1. Compression type gaskets. Extruded EPDM (Ethylene Propylene Diene Monomer) push in place gasket. Dense 60 Durometer Shore "A" - ASTM C864 Option II
  - 2. Structural silicone compatible gasket: true silicone gasket -70 Durometer Shore "A", complying with ASTM C1115, Type C.
  
- C. Thermal isolators: extruded rigid Geon complying with AAMA-303 and ASTM-D-1784-9.
  
- D. End Dams: Pre-molded end dams made from closed cell EPDM (Ethylene Propylene Diene Monomer) sponge to ASTM C509.

## 2.4 SUN CONTROL:

- A. Vertical Sunshade:

### PLCW-600 - 3

- B. Horizontal Sunshade:
- C. Light Shelf Adaptable:

## 2.5 FINISH

- A. Class II clear anodized aluminum shall conform to AA-M12-C22-A31.
- B. Class I clear anodized aluminum shall conform to AA-M12-C22-A41.
- C. Class II color anodized aluminum shall conform to AA-M12-C22-A34.
  - 1. Color: Champagne.
  - 2. Color: Light Bronze.
  - 3. Color: Medium Bronze.
  - 4. Color: Dark Bronze.
  - 5. Color: Black.
- D. Class I color anodized aluminum shall conform to AA-M12-C22-A44.
  - 1. Color: Champagne.
  - 2. Color: Light Bronze.
  - 3. Color: Medium Bronze.
  - 4. Color: Dark Bronze.
  - 5. Color: Black.
- E. Fluorocarbon finish complying with AAMA 2605.
  - 1. Resin: 70% PVDF resin shall be Kynar using Kynar500/Hylar5000.
  - 2. Cleaned and pretreated with chromium phosphate
  - 3. Coat extrusions with approved primers to minimum dry film thickness of 0.20 mil (.0051 mm).
  - 4. Color coat shall be a minimum dry film thickness of 1.0 mil (.025 mm).
  - 5. Approved Coating Manufacturers:
    - a. PPG Industries
    - b. Valspar Corporation

## **EXECUTION**

- A. Do not begin installation until substrates have been properly prepared.
- B. If substrate preparation is the responsibility of another installer, notify Architect of unsatisfactory preparation before proceeding.

## 3.2 PREPARATION

- A. Clean surfaces thoroughly prior to installation.
- B. Prepare surfaces using the methods recommended by the manufacturer for achieving the best result for the substrate under the project conditions.

## 3.3 INSTALLATION

- A. Install in accordance with manufacturer's instructions.

## 3.4 FIELD QUALITY CONTROL

- A. Owner will engage an independent AAMA approved testing agency.



- B. Conduct test under the supervision of and in the presence of the Owner, Architect, and Construction Manager.
- C. Test wall in accordance with AAMA 501.2-94.

### 3.5 PROTECTION

- A. Protect installed products until completion of project.
- B. Touch-up, repair or replace damaged products before Substantial Completion.

END OF SECTION



**PLCW-600 SERIES**

**2 1/2" x 6"**

**1/4 SCALE**

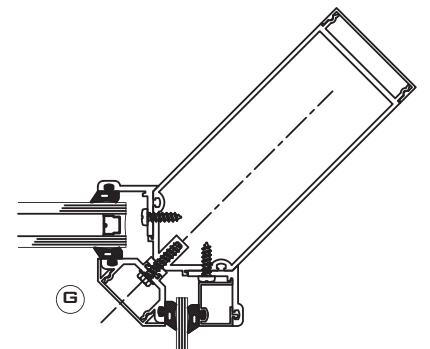
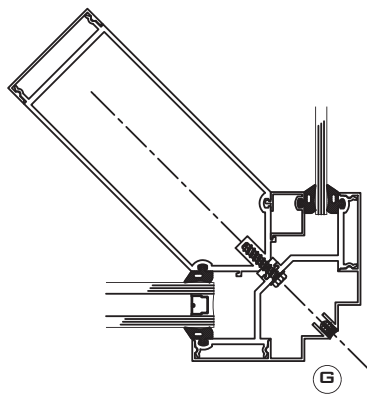
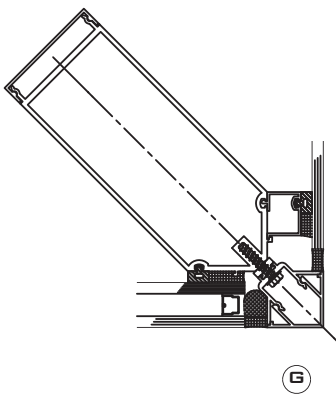
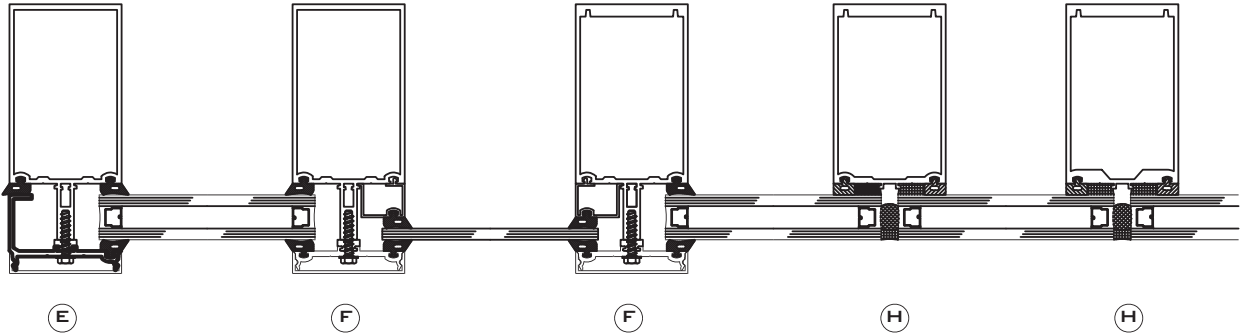
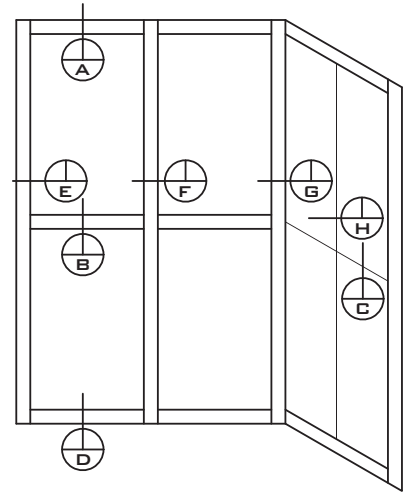
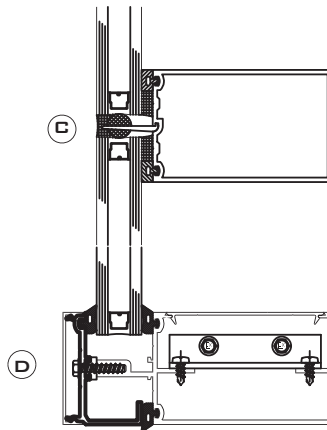
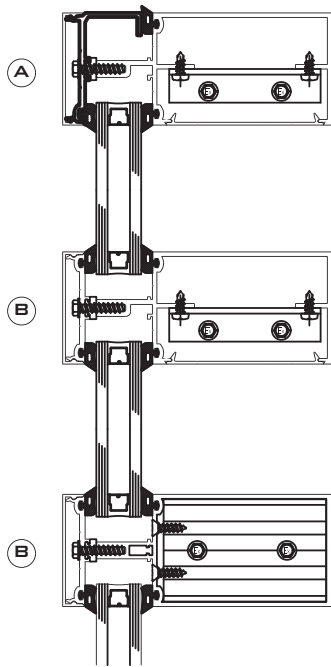

**PLCW-600 - 6**

14760 Don Julian Rd.  
Industry, CA 91746

ph: (877) 775-2586  
fx: (877) 274-8800

[www.prlaluminum.com](http://www.prlaluminum.com)  
[sales@prlaluminum.com](mailto:sales@prlaluminum.com)

**PLCW-600 SERIES**  
**2 1/2" x 6"**  
**1/4 SCALE**

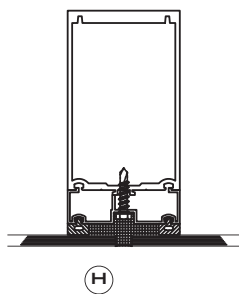
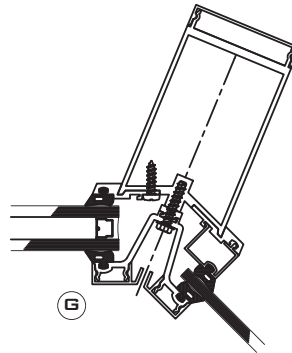
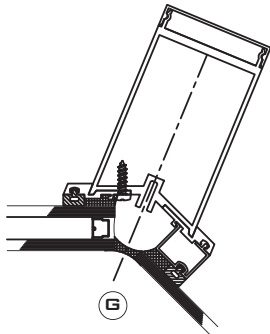
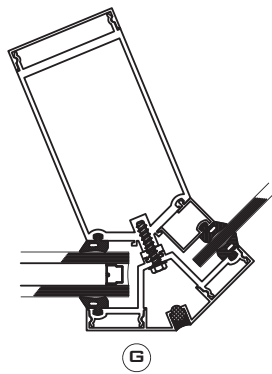
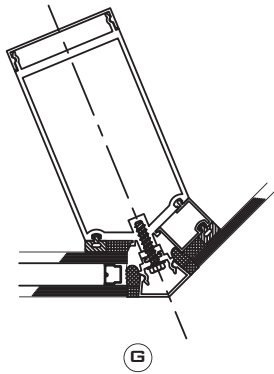

ph: (877) 775-2586  
fx: (877) 274-8800

**PLCW-600 - 7**  
14760 Don Julian Rd.  
Industry, CA 91746

[www.prlaluminum.com](http://www.prlaluminum.com)  
[sales@prlaluminum.com](mailto:sales@prlaluminum.com)

**PLCW-600 SERIES**  
**2 1/2" x 6"**  
**FULL SCALE**

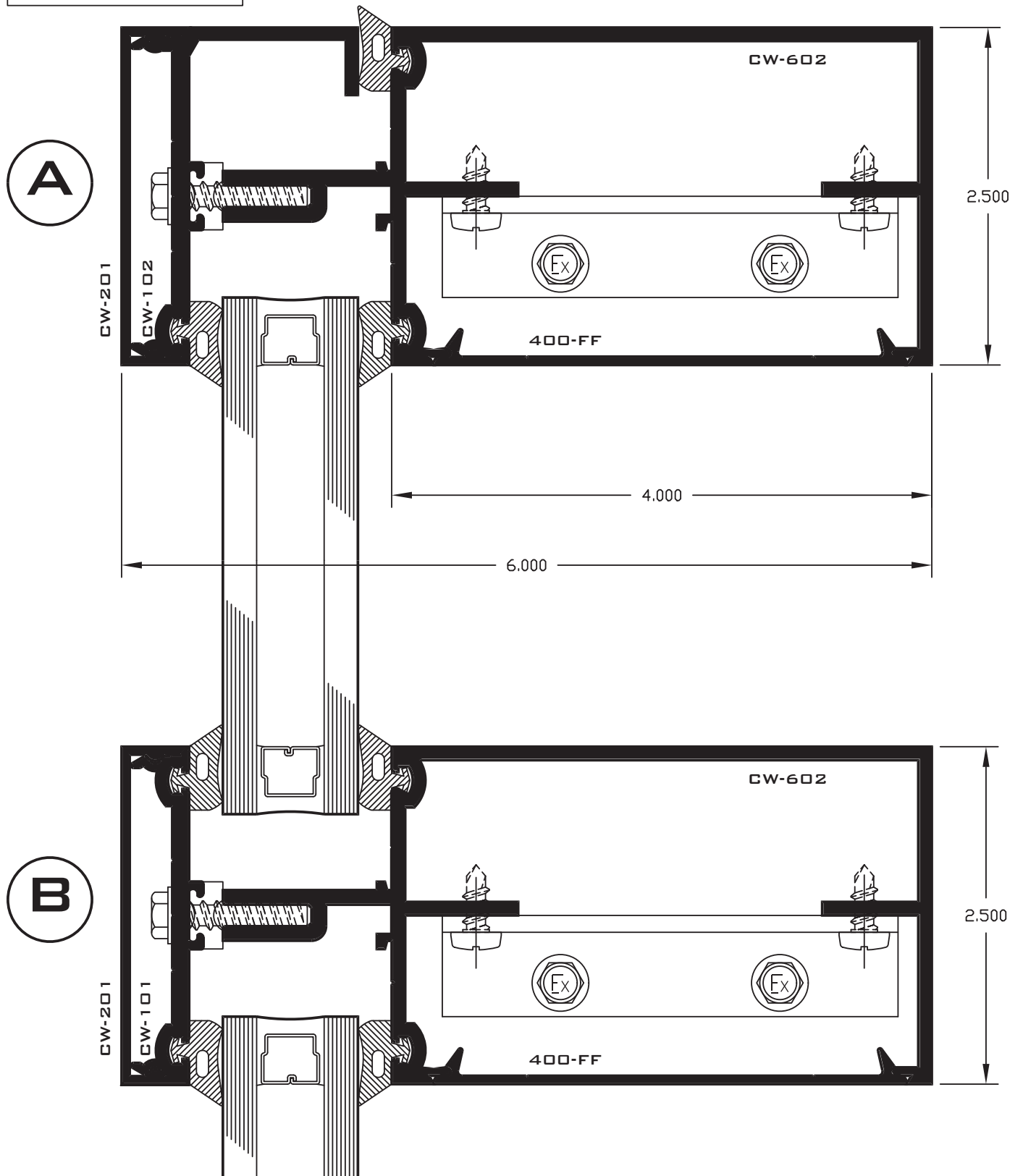

**PLCW-600 - 8**

14760 Don Julian Rd.  
 Industry, CA 91746

ph: (877) 775-2586  
 fx: (877) 274-8800

[www.prlaluminum.com](http://www.prlaluminum.com)  
[sales@prlaluminum.com](mailto:sales@prlaluminum.com)

PLCW-600 SERIES  
2 1/2" x 6"  
FULL SCALE

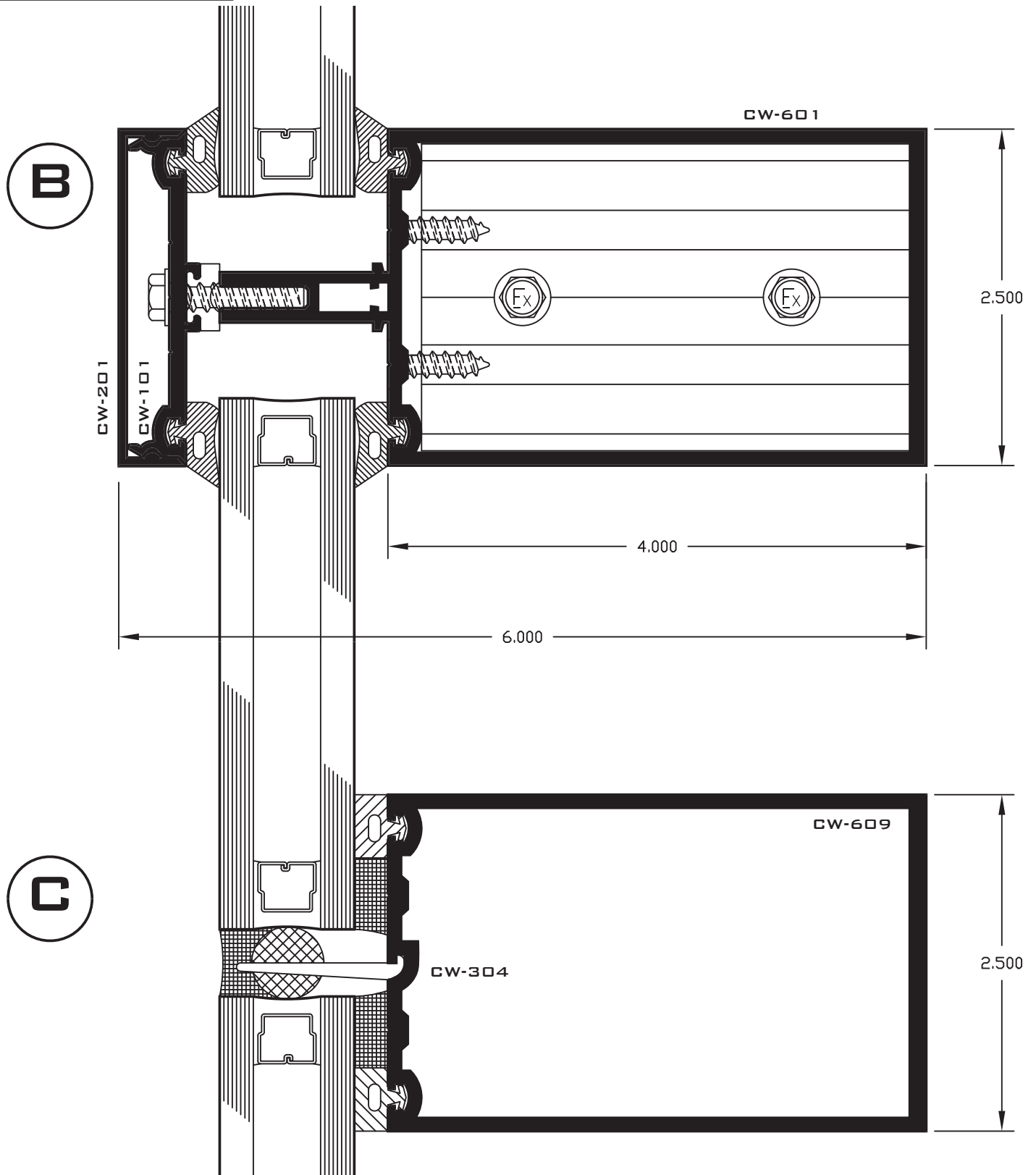

PLCW-600 - 9

14760 Don Julian Rd.  
Industry, CA 91746

ph: (877) 775-2586  
fx: (877) 274-8800

www.prlaluminum.com  
sales@prlaluminum.com

**PLCW-600 SERIES**  
 2 1/2" x 6"  
 FULL SCALE



**DETAIL AT SPANDREL**

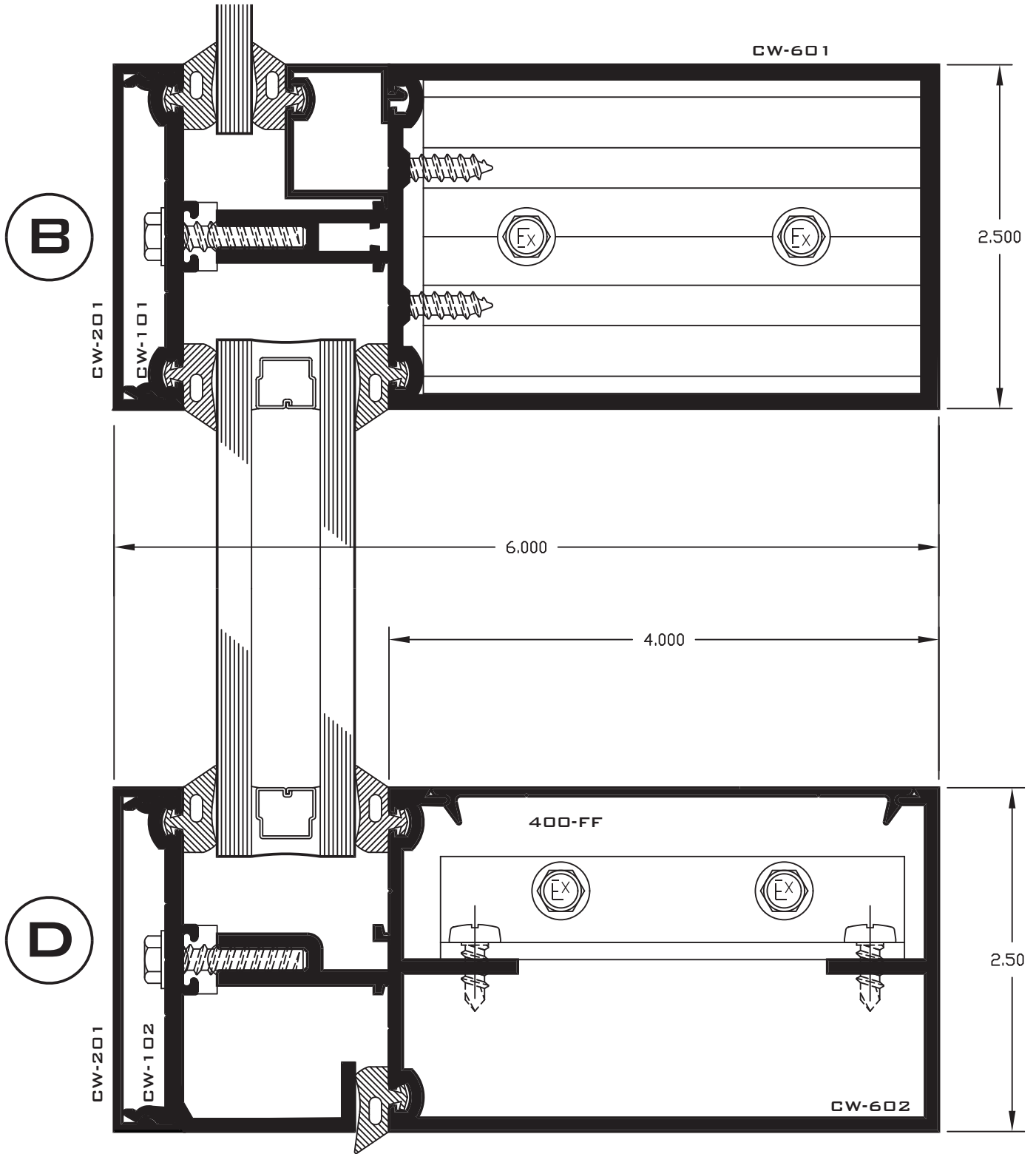

ph: (877) 775-2586  
 fx: (877) 274-8800

**PLCW-600 - 10**  
 14760 Don Julian Rd.  
 Industry, CA 91746

[www.prlaluminum.com](http://www.prlaluminum.com)  
[sales@prlaluminum.com](mailto:sales@prlaluminum.com)

**PLCW-600 SERIES**  
**2 1/2" x 6"**  
**FULL SCALE**

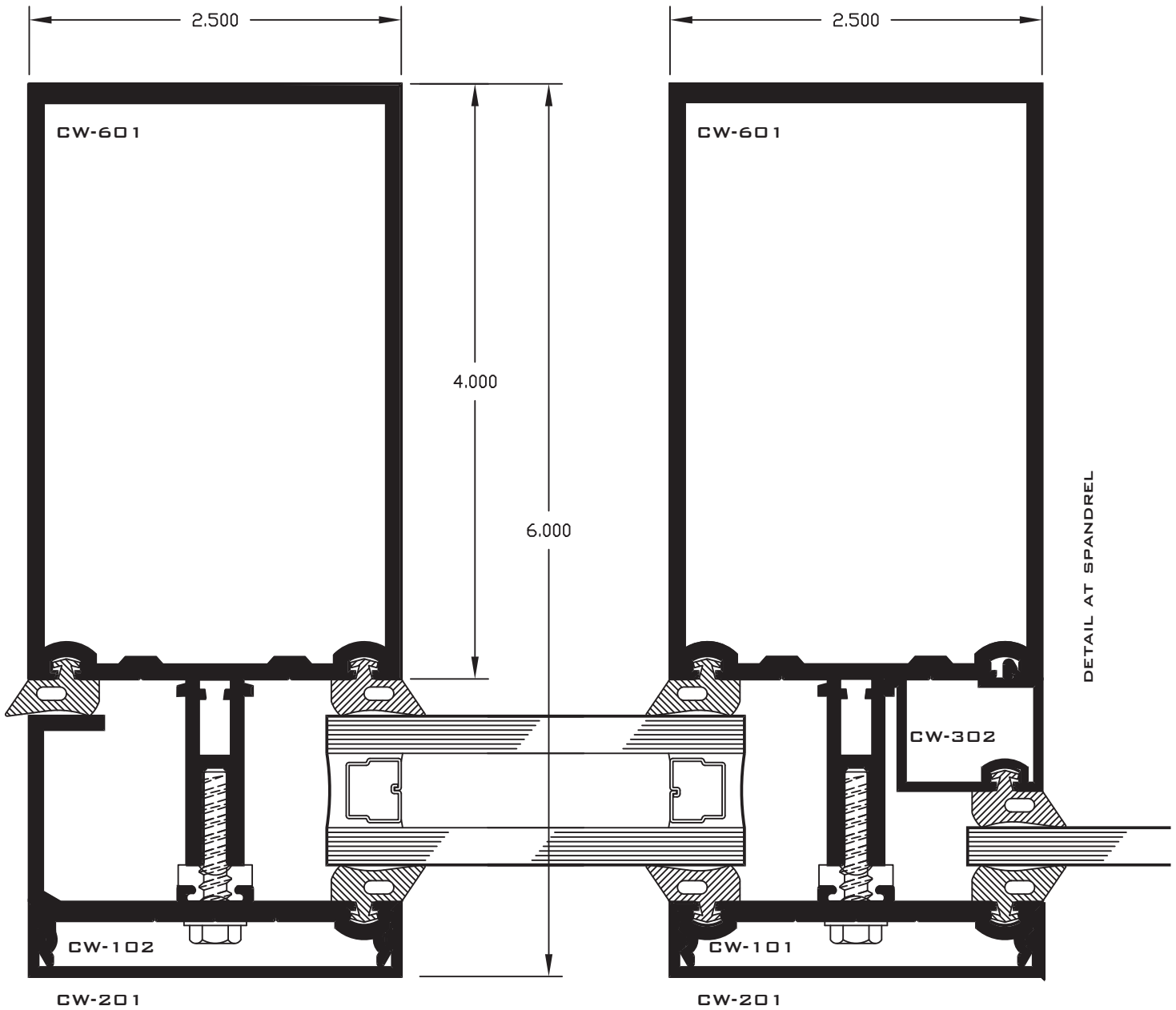

**E**

**F**

ph: (877) 775-2586  
 fx: (877) 274-8800

**PLCW-600 - 11**  
 14760 Don Julian Rd.  
 Industry, CA 91746

[www.prlaluminum.com](http://www.prlaluminum.com)  
[sales@prlaluminum.com](mailto:sales@prlaluminum.com)



**PLCW-600 SERIES**  
**2 1/2" x 6"**  
**FULL SCALE**

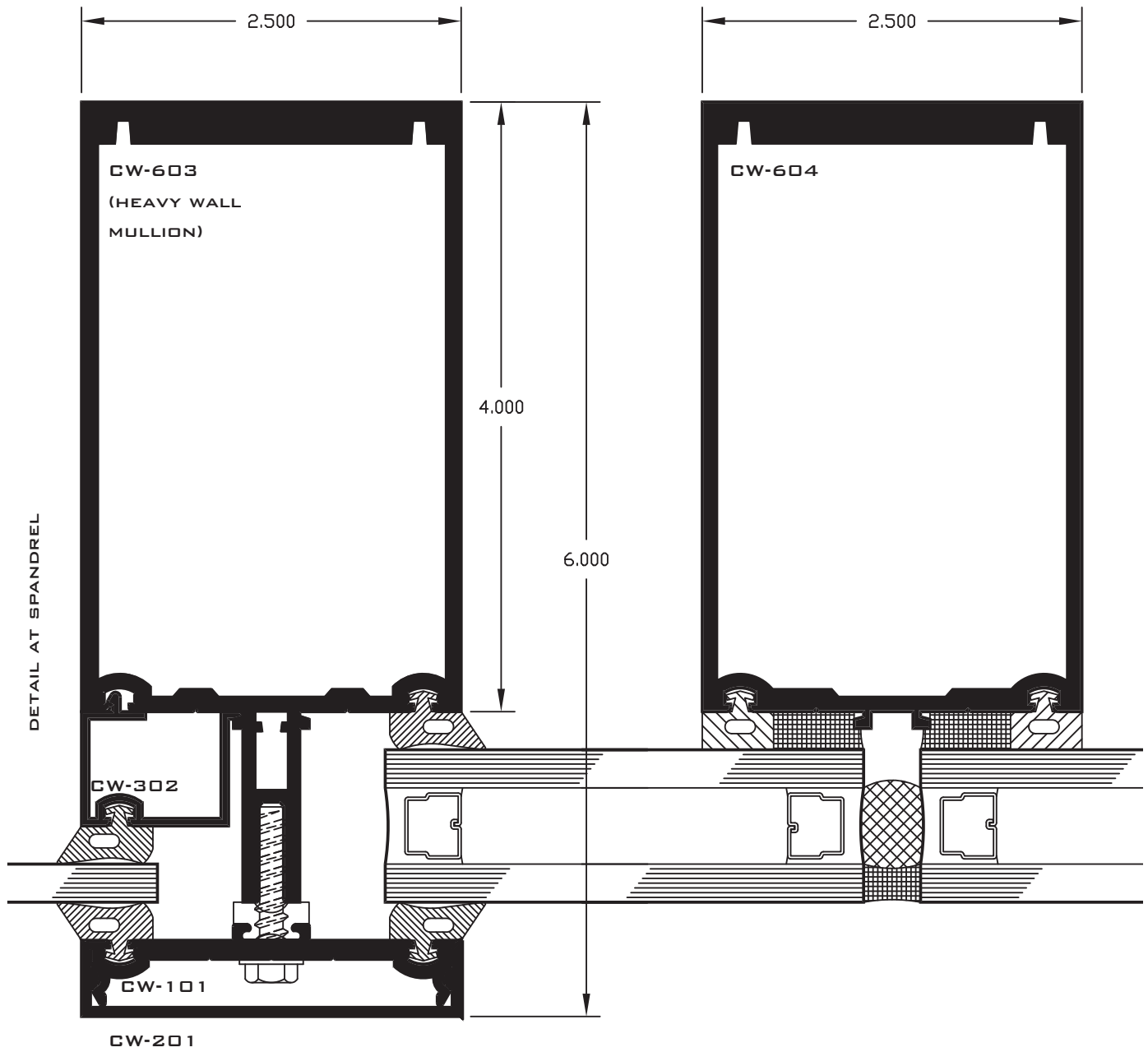

ph: (877) 775-2586  
 fx: (877) 274-8800

**PLCW-600 - 12**  
 14760 Don Julian Rd.  
 Industry, CA 91746

[www.prlaluminum.com](http://www.prlaluminum.com)  
[sales@prlaluminum.com](mailto:sales@prlaluminum.com)

**PLCW-600 SERIES**  
**2 1/2" x 6"**  
**FULL SCALE**

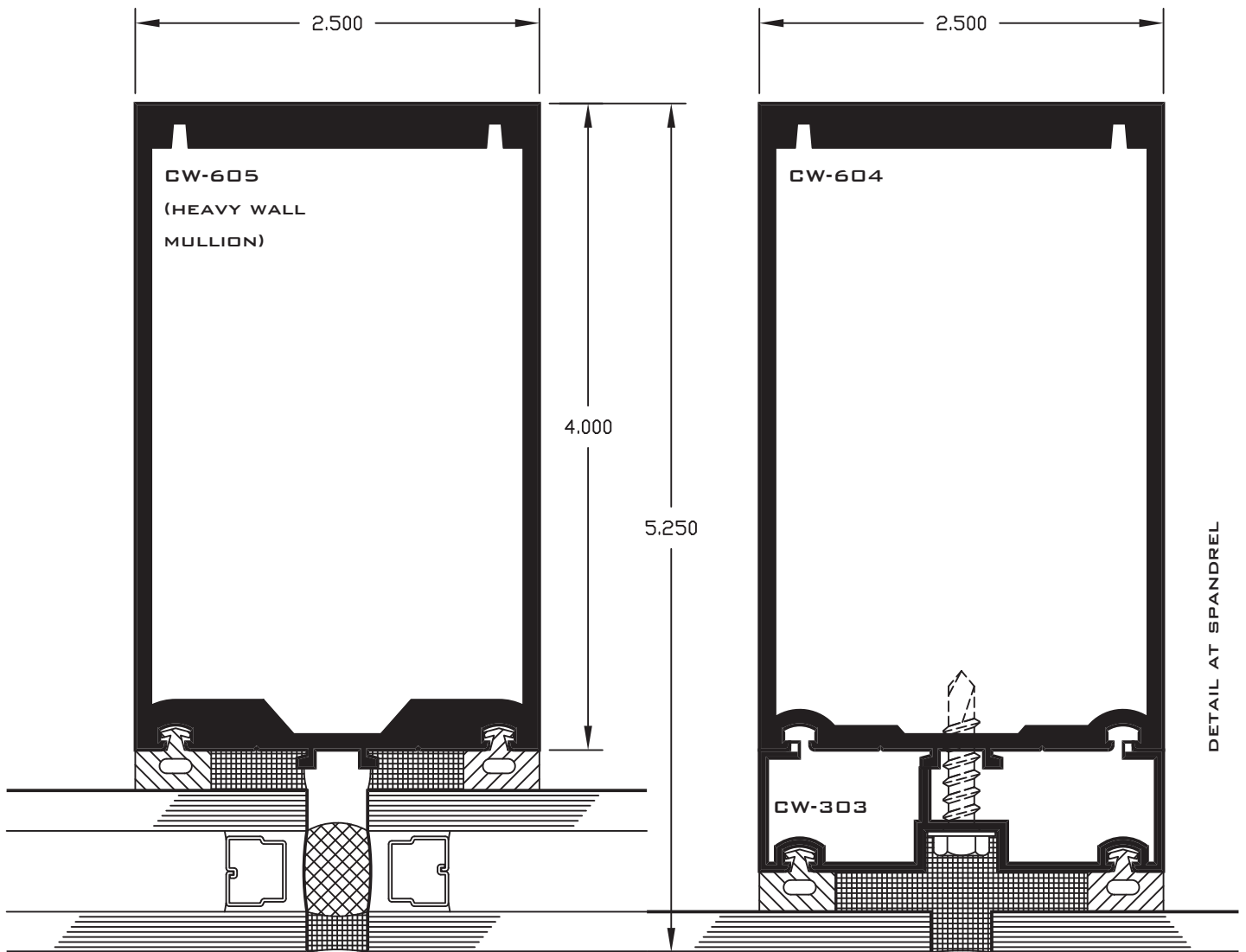

**PLCW-600 SERIES**  
**2 1/2" x 6"**  
**FULL SCALE**

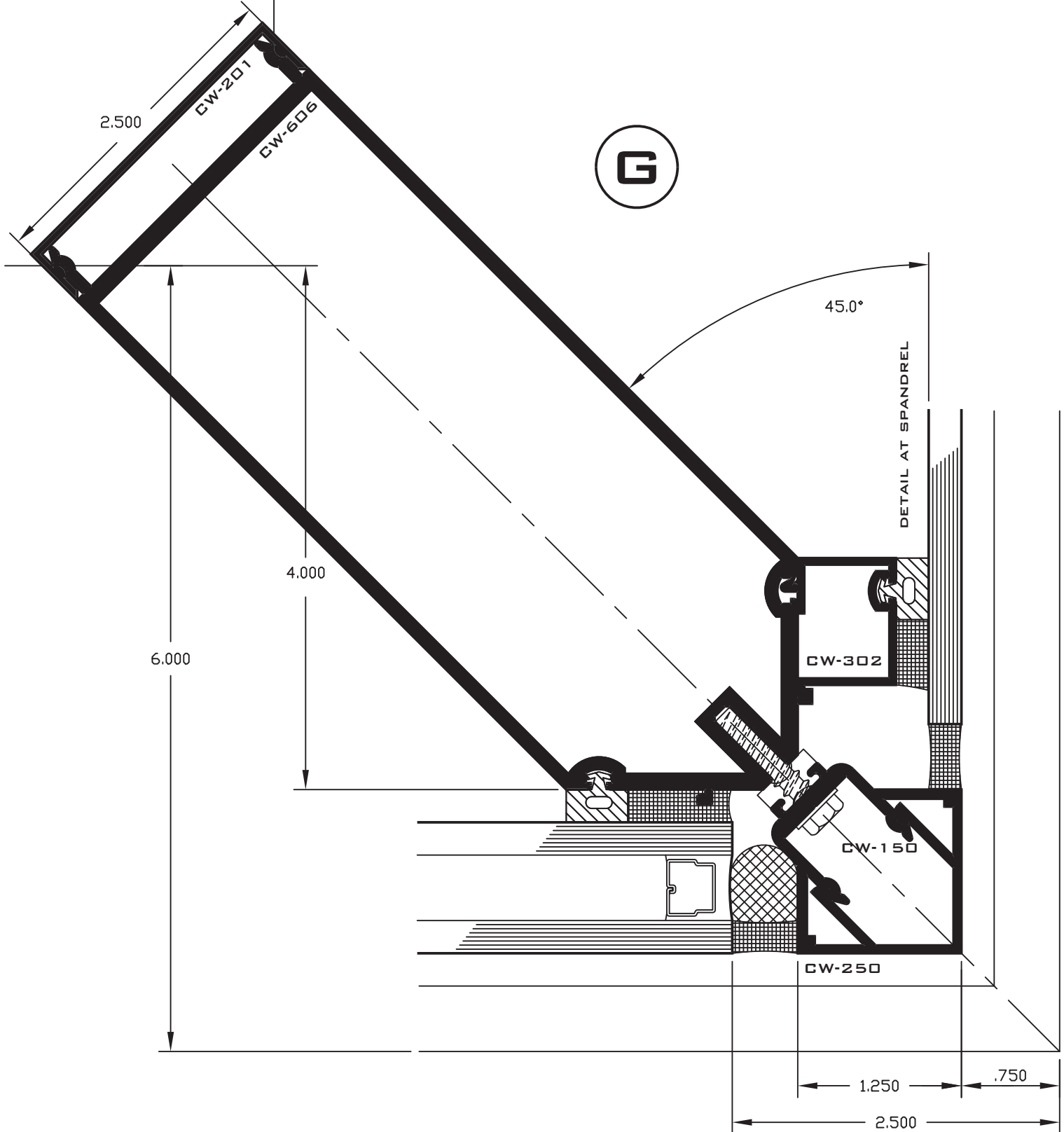

**PLCW-600 - 14**  
 14760 Don Julian Rd.  
 Industry, CA 91746

ph: (877) 775-2586  
 fx: (877) 274-8800

[www.prlaluminum.com](http://www.prlaluminum.com)  
[sales@prlaluminum.com](mailto:sales@prlaluminum.com)

**PLCW-600 SERIES**  
**2 1/2" x 6"**  
**FULL SCALE**

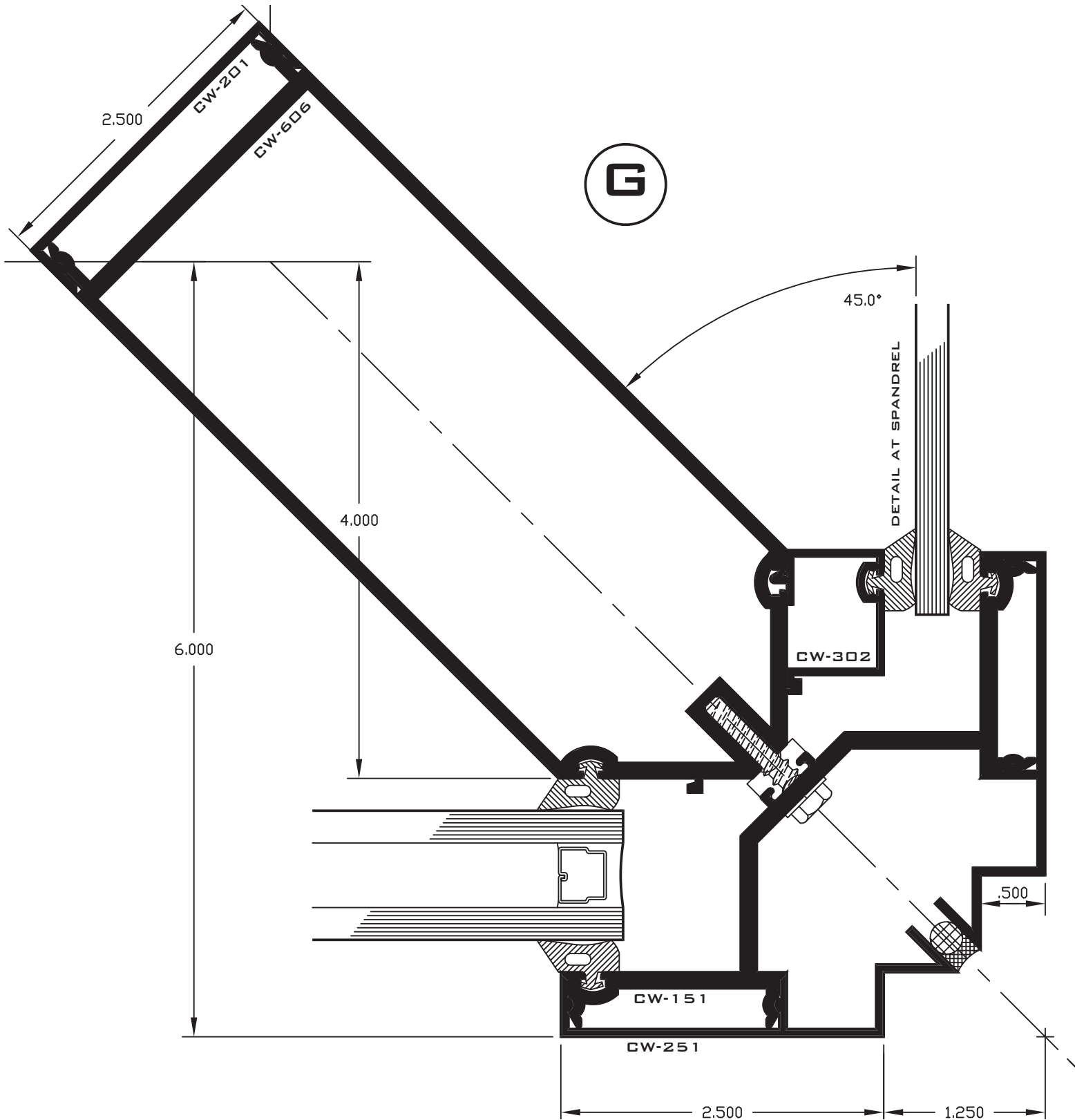

**PLCW-600 - 15**

14760 Don Julian Rd.  
 Industry, CA 91746

ph: (877) 775-2586  
 fx: (877) 274-8800

[www.prlaluminum.com](http://www.prlaluminum.com)  
[sales@prlaluminum.com](mailto:sales@prlaluminum.com)

**PLCW-600 SERIES**

**2 1/2" x 6"**

**FULL SCALE**

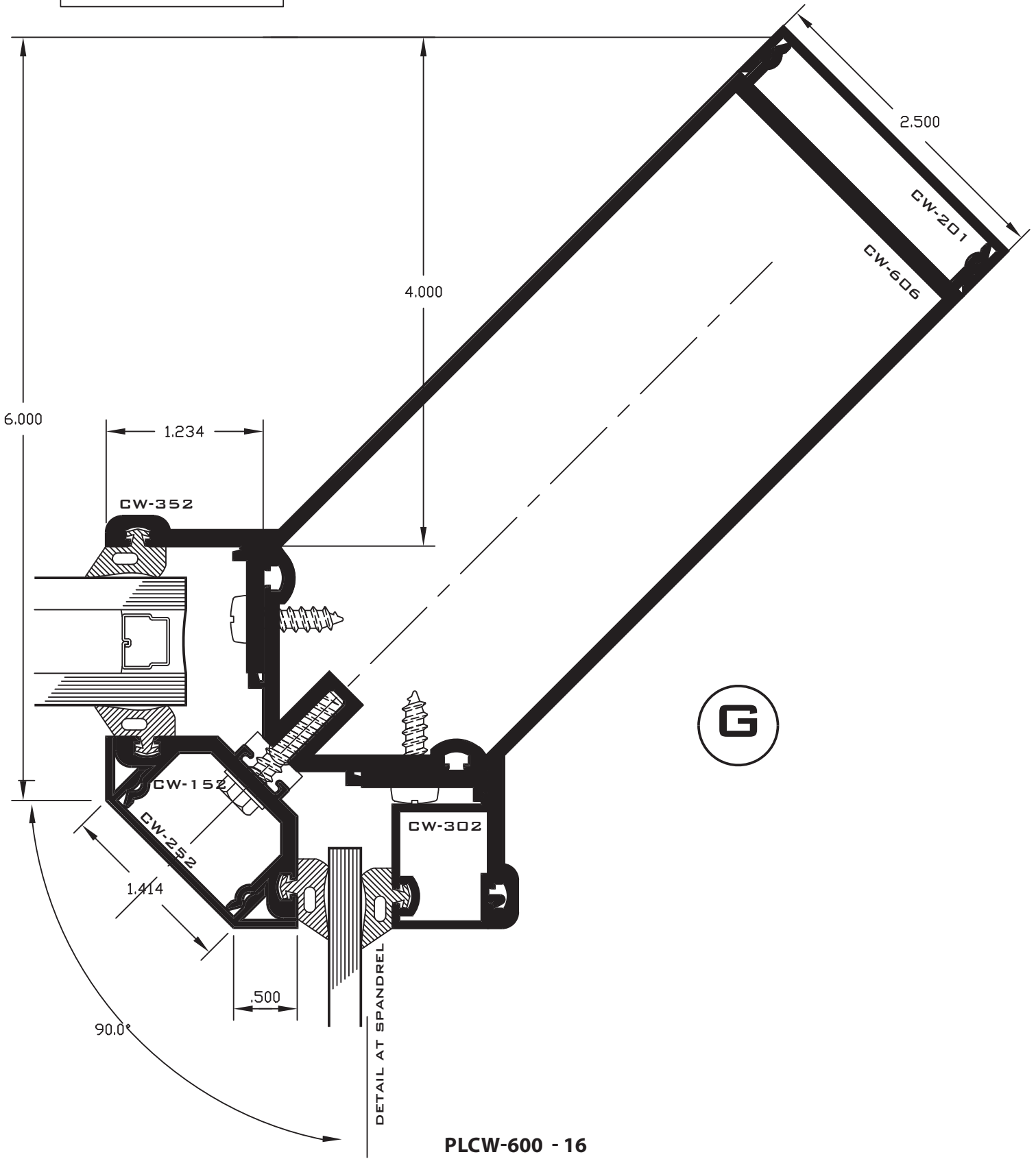

ph: (877) 775-2586  
fx: (877) 274-8800

**PLCW-600 - 16**  
14760 Don Julian Rd.  
Industry, CA 91746

[www.prlaluminum.com](http://www.prlaluminum.com)  
[sales@prlaluminum.com](mailto:sales@prlaluminum.com)

PLCW-600 SERIES  
2 1/2" x 6"  
FULL SCALE

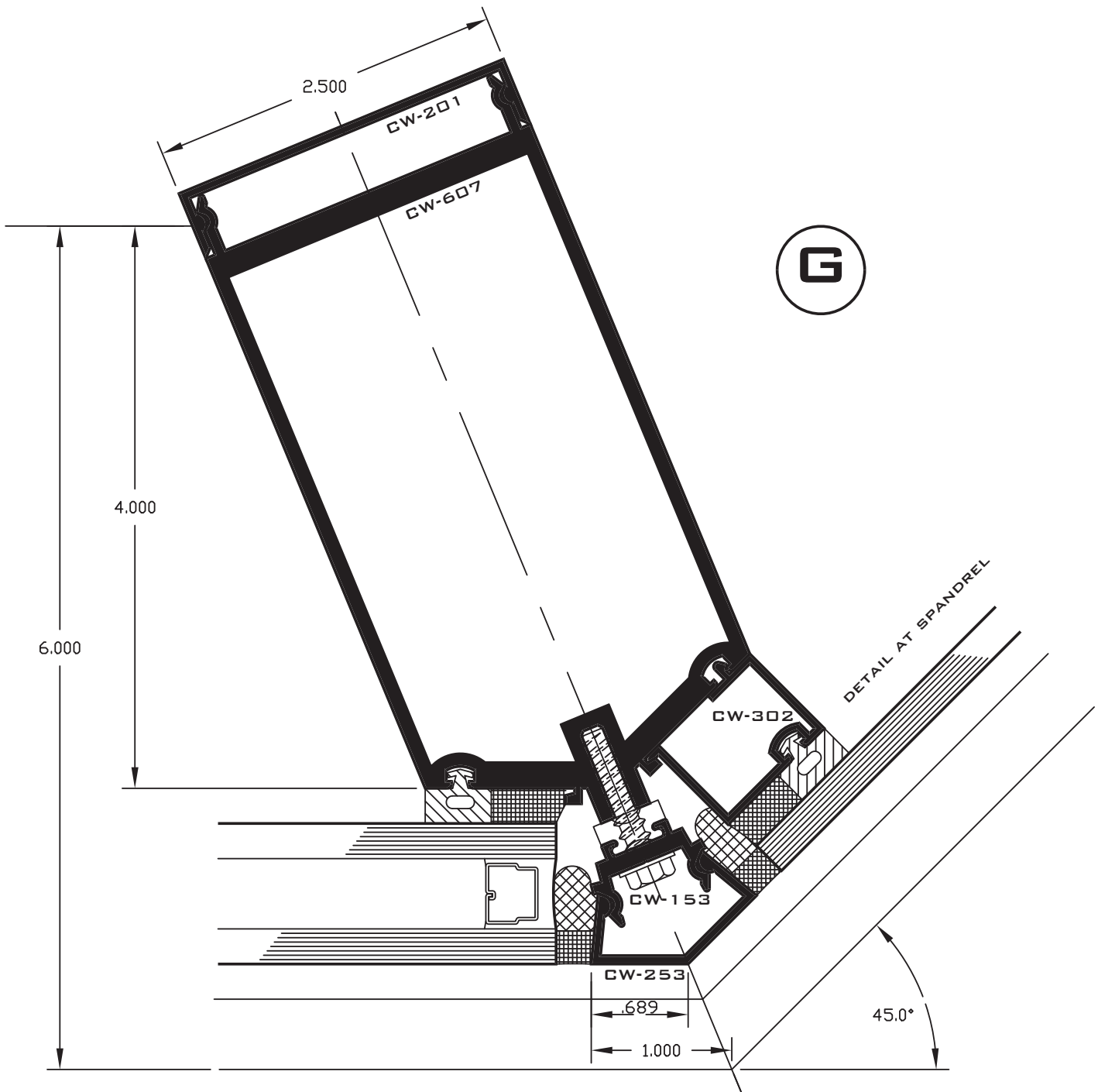

ph: (877) 775-2586  
fx: (877) 274-8800

PLCW-600 - 17  
14760 Don Julian Rd.  
Industry, CA 91746

www.prlaluminum.com  
sales@prlaluminum.com

**PLCW-600 SERIES**  
**2 1/2" x 6"**  
**FULL SCALE**

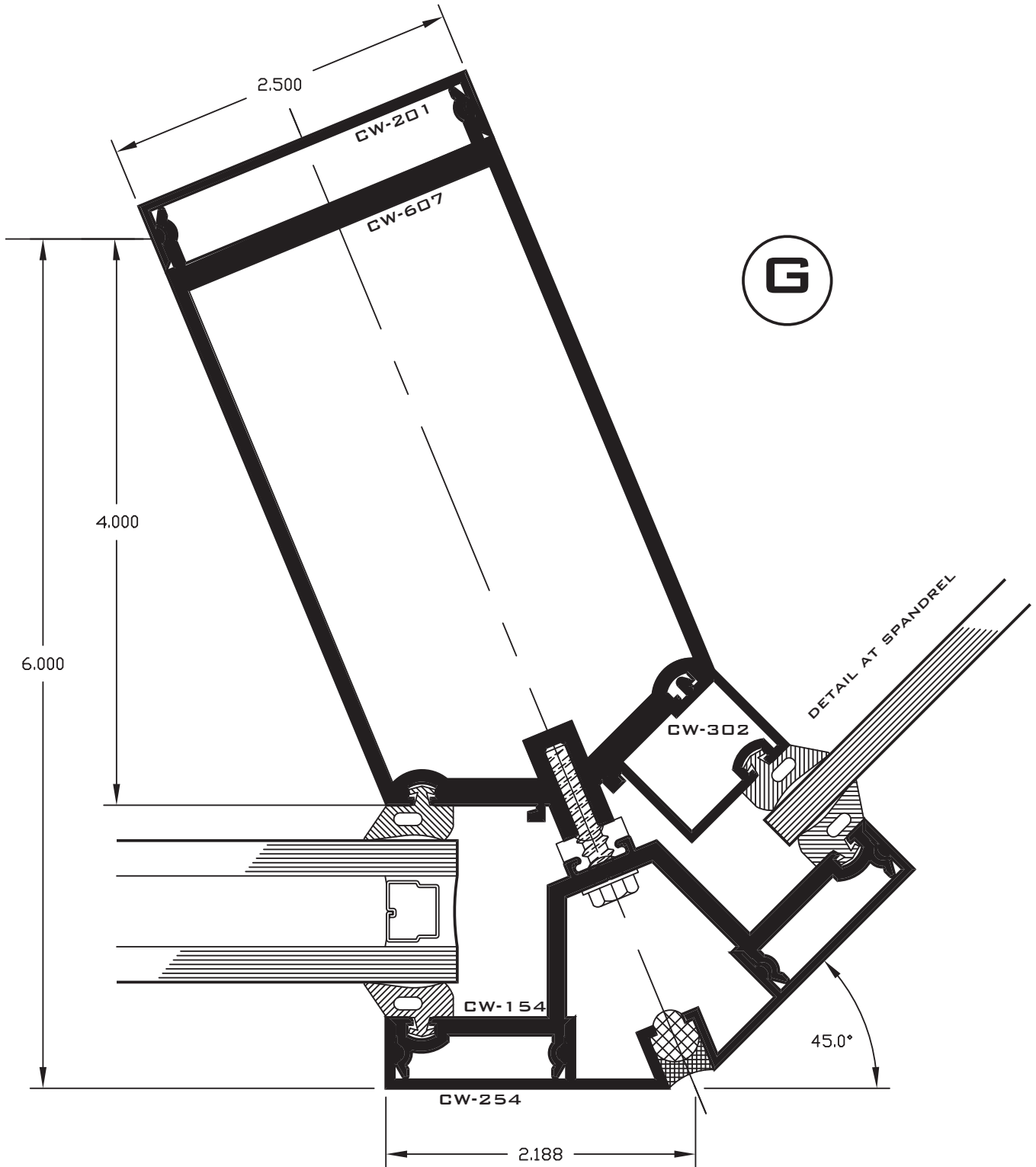

ph: (877) 775-2586  
 fx: (877) 274-8800

**PLCW-600 - 18**  
 14760 Don Julian Rd.  
 Industry, CA 91746

[www.prlaluminum.com](http://www.prlaluminum.com)  
[sales@prlaluminum.com](mailto:sales@prlaluminum.com)

PLCW-600 SERIES  
2 1/2" x 6"  
FULL SCALE

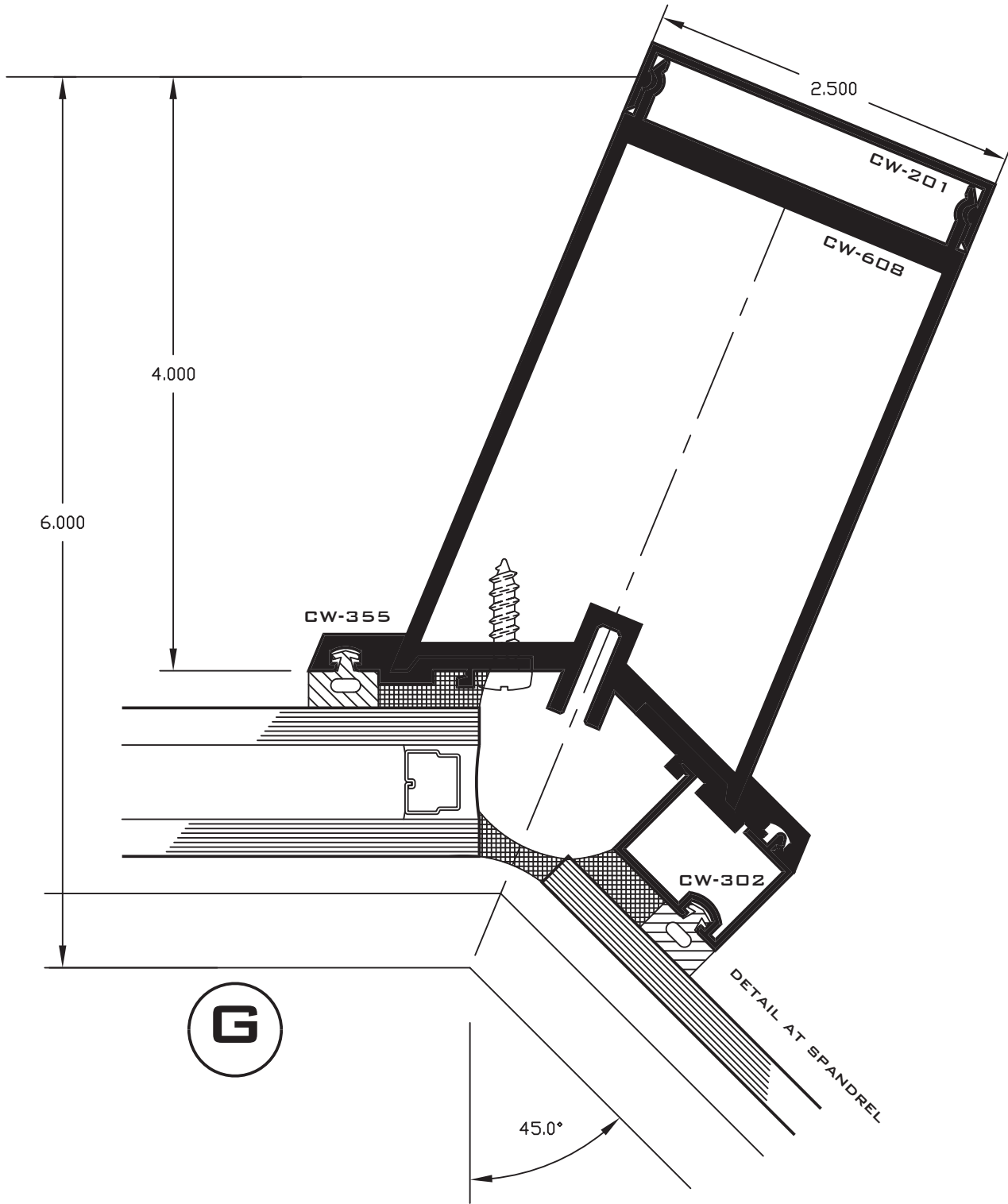

ph: (877) 775-2586  
fx: (877) 274-8800

PLCW-600 - 19  
14760 Don Julian Rd.  
Industry, CA 91746

www.prlaluminum.com  
sales@prlaluminum.com



**PLCW-600 SERIES**  
**2 1/2" x 6"**  
**FULL SCALE**

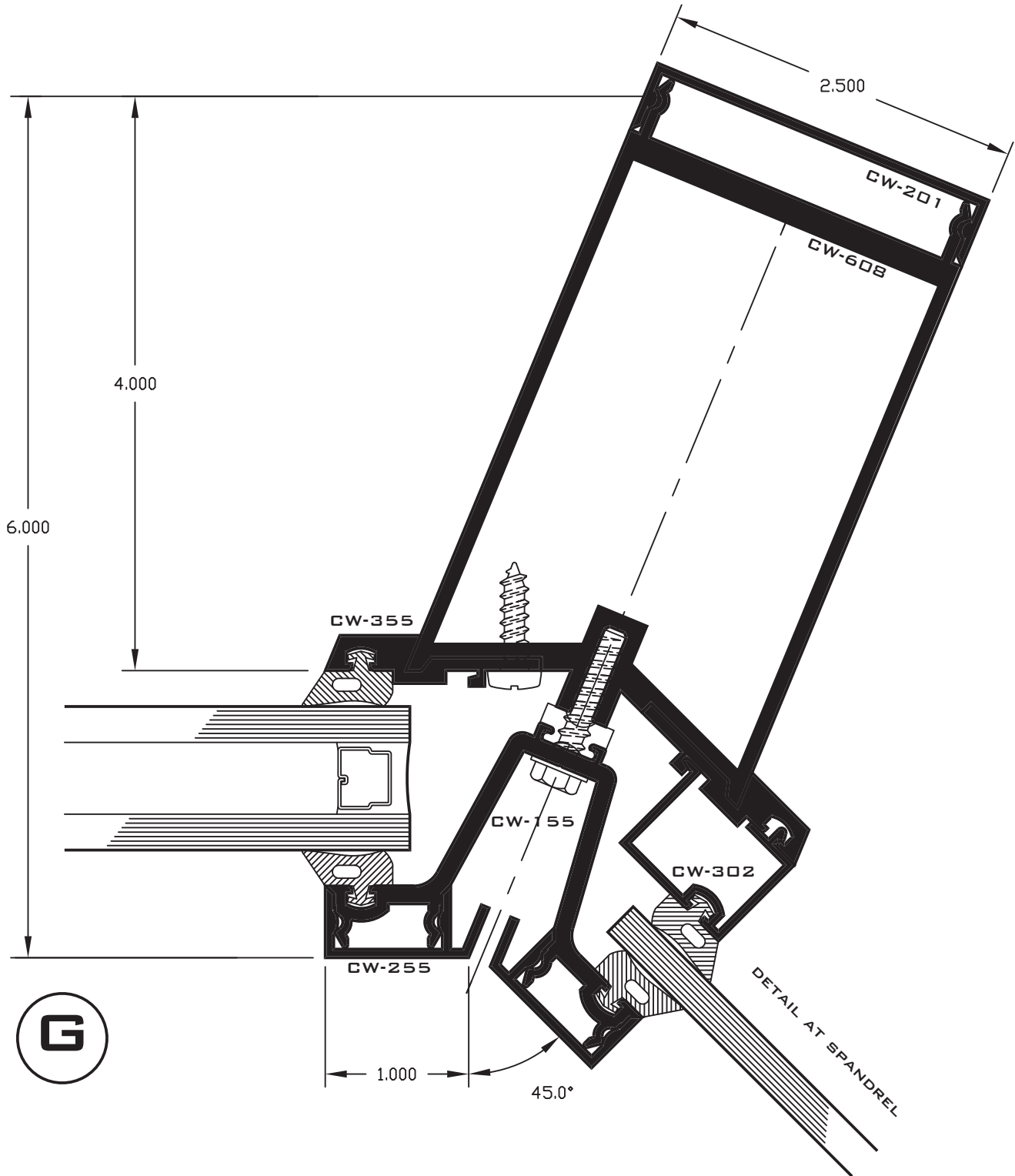

ph: (877) 775-2586  
fx: (877) 274-8800

**PLCW-600 - 20**  
14760 Don Julian Rd.  
Industry, CA 91746

[www.prlaluminum.com](http://www.prlaluminum.com)  
[sales@prlaluminum.com](mailto:sales@prlaluminum.com)



## wind load design

Mullion deflection is limited per AAMA TIR-A11-04  
deflection is limited to L/175 for spans up to 13'-6"  
and L/240 for spans beyond 13'-6"

allowable stress for 6063-T6 aluminum alloy = 15000 p.s.i.  
allowable stress for A-36 steel = 21600 p.s.i.

maximum deflection was based on the following equation:

$$\Delta = \frac{5WL^3}{384EI}$$

maximum bending moment was based on the following equation:

$$M = \frac{WL}{8}$$

assumptions:

W = total uniform load

L = length of mullion between anchors

E =  $10 \times 10^6$  p.s.i.

I = moment of inertia of the mullion

M = maximum bending moment

\* mullions are assumed to have equal size glass lights each side

check with local code requirements for acceptance of AAMA TIR-A11

**PLCW-600 SERIES**  
**2 1/2" x 6"**  
**WIND LOAD**

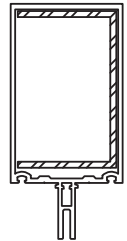
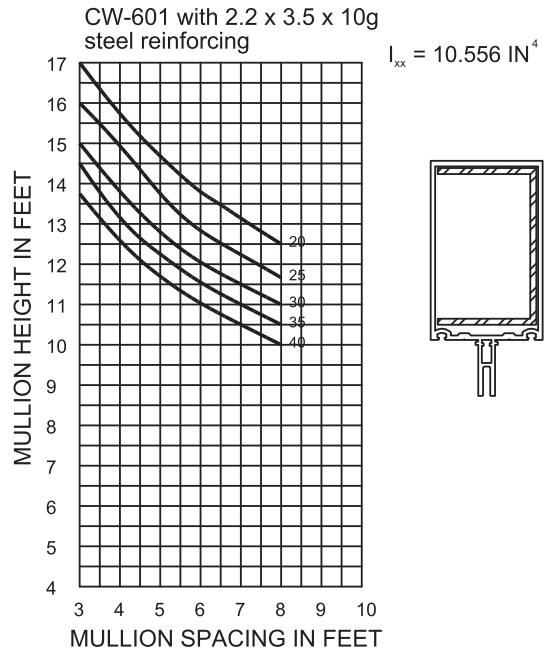
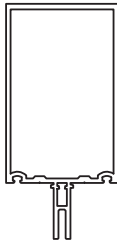
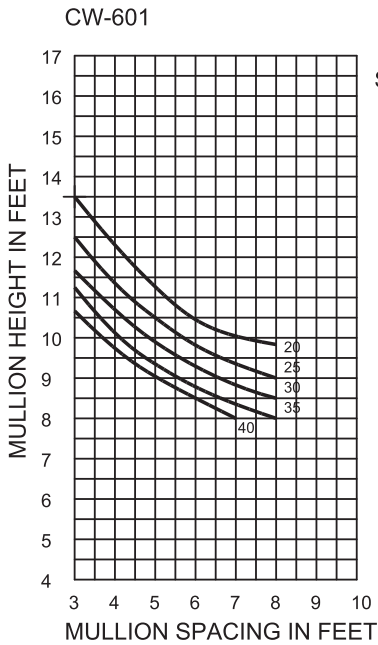

**CURVE REPRESENTATION**

A	= 20 P.S.F.
B	= 25 P.S.F.
C	= 30 P.S.F.
D	= 35 P.S.F.
E	= 40 P.S.F.

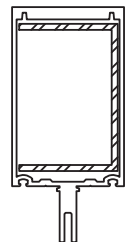
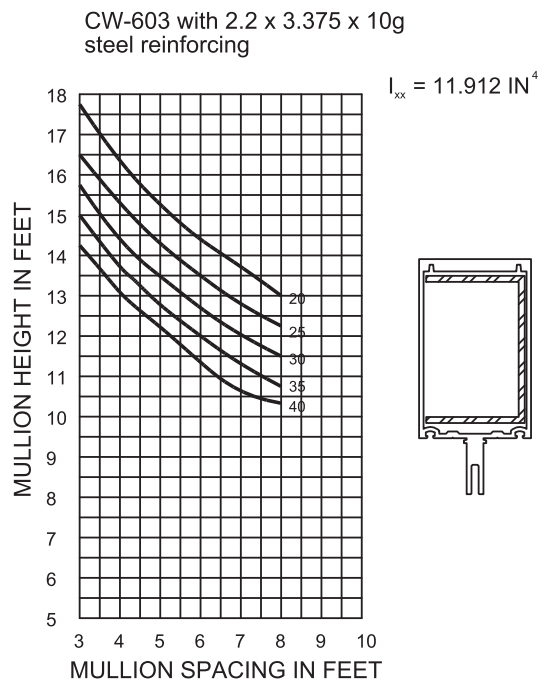
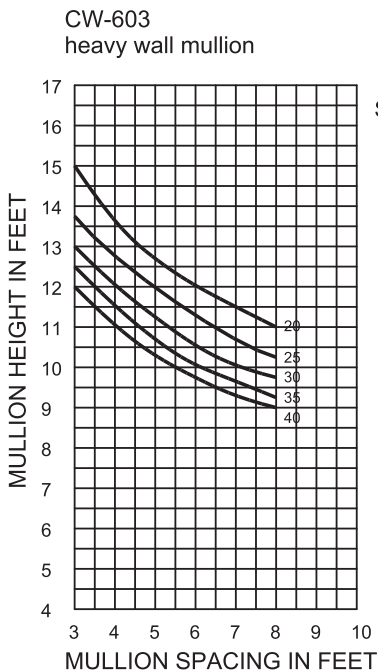

**PLCW-600 - 22**

ph: (877) 775-2586  
 fx: (877) 274-8800

14760 Don Julian Rd.  
 Industry, CA 91746

www.prlaluminum.com  
 sales@prlaluminum.com

**PLCW-600 SERIES**  
**2 1/2" x 6"**  
**WIND LOAD**

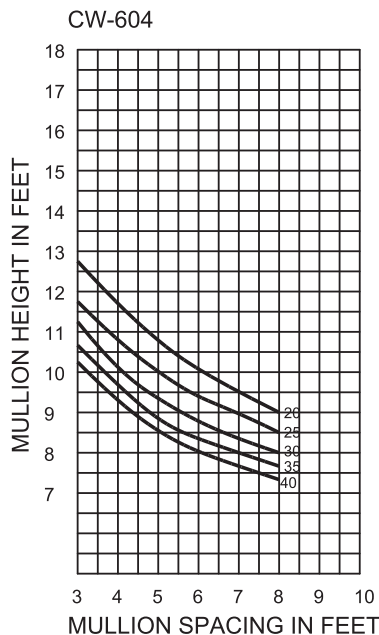

$I_{xx} = 4.153 \text{ IN}^4$   
 $S_{xx} = 1.794 \text{ IN}^3$

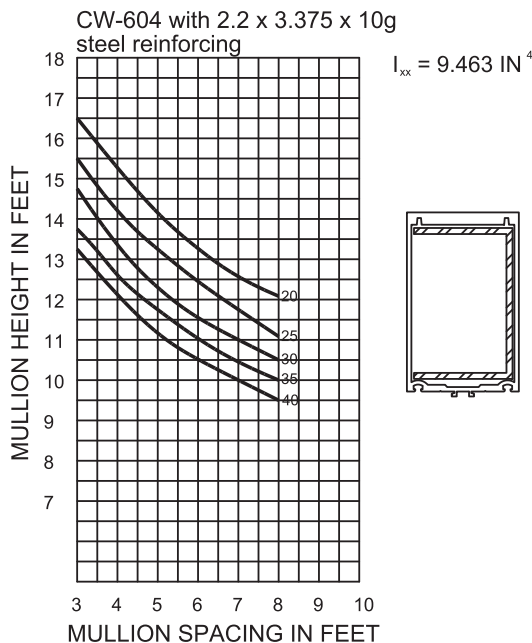
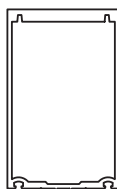

$I_{xx} = 9.463 \text{ IN}^4$

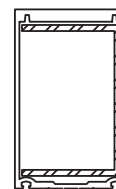

**CURVE REPRESENTATION**

A	=	20 P.S.F.
B	=	25 P.S.F.
C	=	30 P.S.F.
D	=	35 P.S.F.
E	=	40 P.S.F.

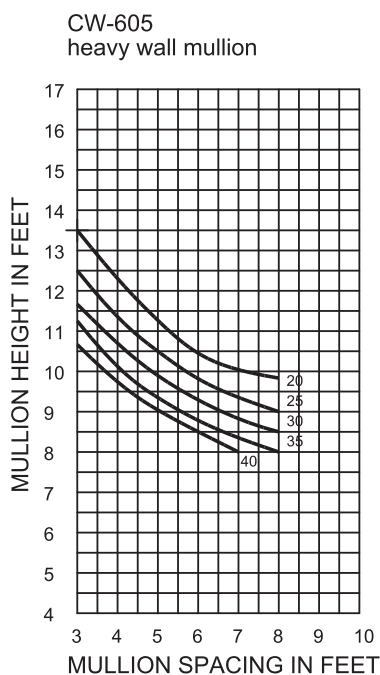

$I_{xx} = 4.918 \text{ IN}^4$   
 $S_{xx} = 2.342 \text{ IN}^3$

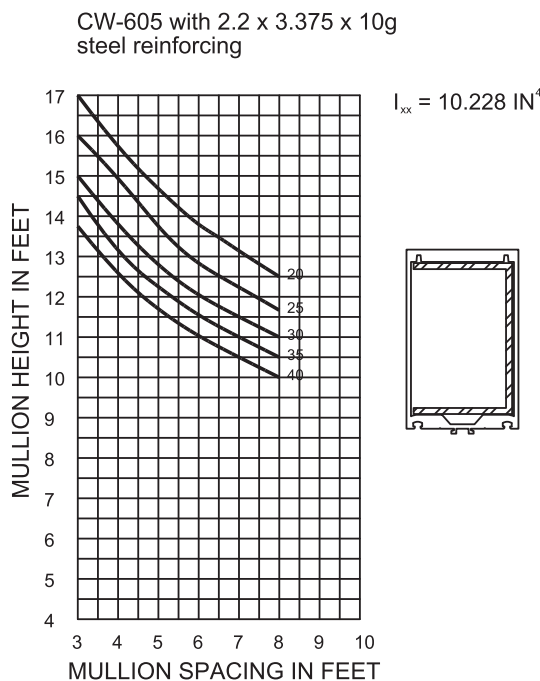
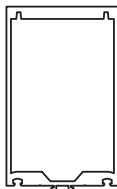

$I_{xx} = 10.228 \text{ IN}^4$

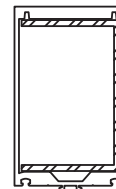

**PLCW-600 SERIES**

**2 1/2" x 6"**

**WIND LOAD**



CW-606  
90° inside/outside corner

$I_{xx} = 10.306 \text{ IN}^4$   
 $S_{xx} = 2.943 \text{ IN}^3$

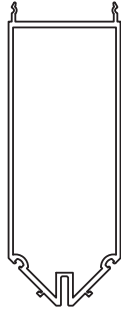
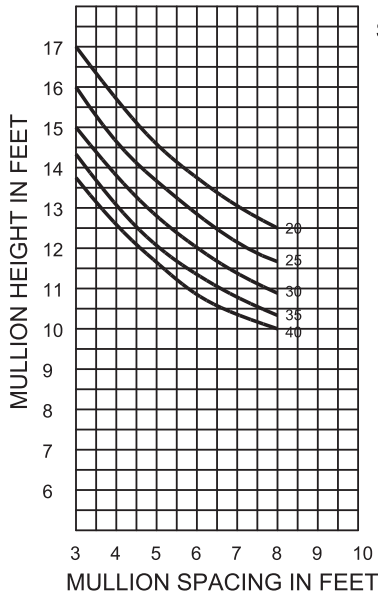

CW-606 with 2.2 x 5.0 x 10g  
steel reinforcing

$I_{xx} = 23.483 \text{ IN}^4$

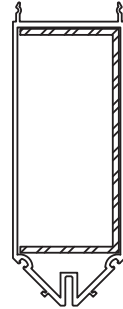
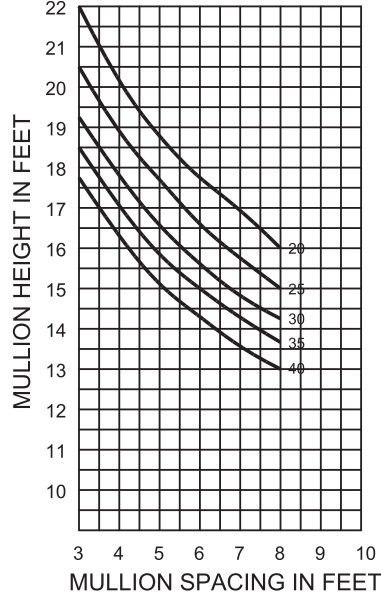

**CURVE REPRESENTATION**

- A = 20 P.S.F.
- B = 25 P.S.F.
- C = 30 P.S.F.
- D = 35 P.S.F.
- E = 40 P.S.F.

CW-607  
135° outside corner mullion

$I_{xx} = 5.915 \text{ IN}^4$   
 $S_{xx} = 2.247 \text{ IN}^3$

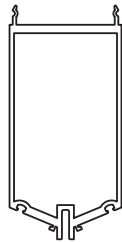
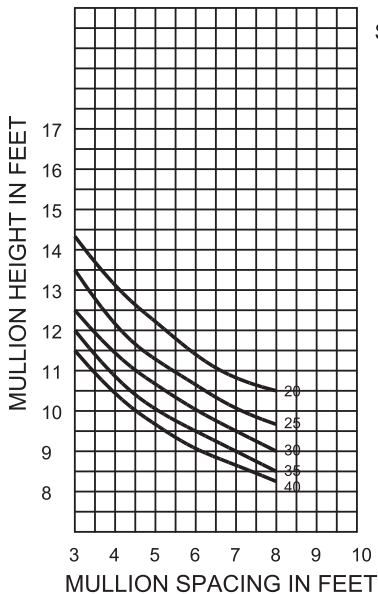

CW-607 with 2.2 x 3.625 x 10g  
steel reinforcing

$I_{xx} = 12.166 \text{ IN}^4$

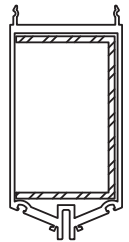
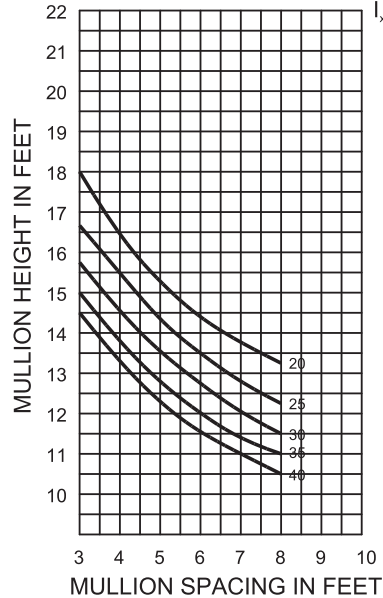

**PLCW-600 SERIES**  
**2 1/2" x 6"**  
**WIND LOAD**

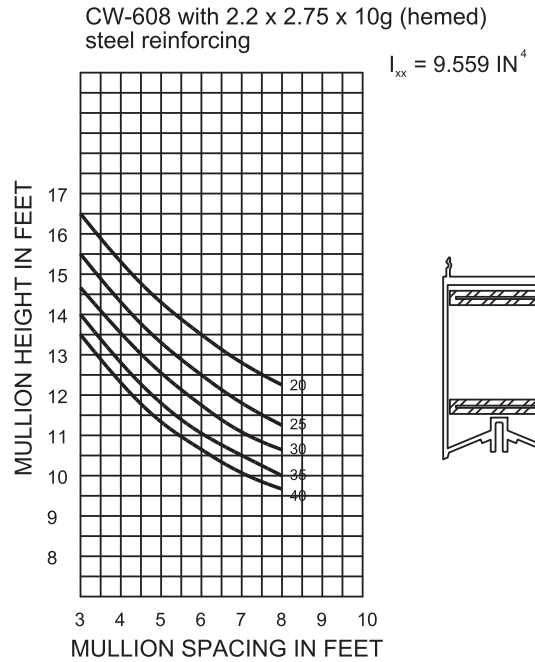
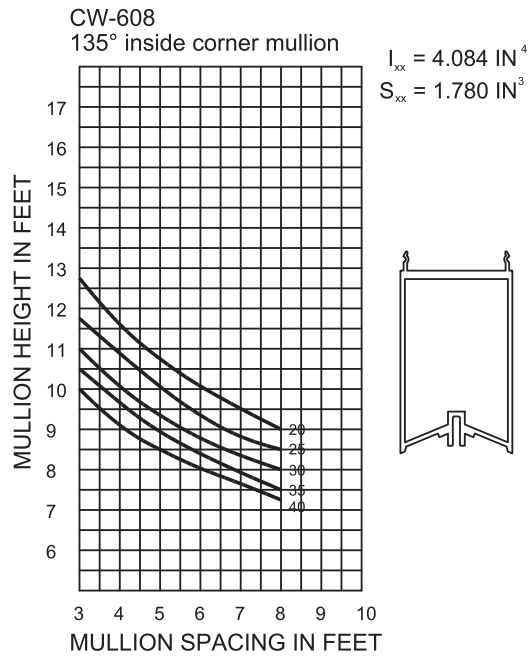

CURVE REPRESENTATION	
A	= 20 P.S.F.
B	= 25 P.S.F.
C	= 30 P.S.F.
D	= 35 P.S.F.
E	= 40 P.S.F.

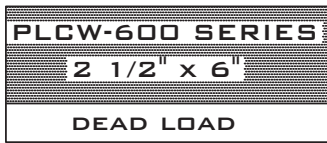

## dead load design

horizontal mullion deflection is limited to  $L/360$  or  $1/8$ " (whichever is less)  
curves represent limitations based on 2 point loads, equal in magnitude  
both located at  $1/8$  or  $1/4$  point of the horizontal mullions length

allowable stress for 6063-T6 aluminum alloy = 15000 p.s.i.  
allowable stress for A-36 steel = 21600 p.s.i.

maximum deflection was based on the following equation:

$$\Delta = \frac{Pa}{24EI} (3L^2 - 4a^2)$$

maximum bending moment was based on the following equation:

$$M = Pa$$

assumptions:

$P = 1/2$  glass weight

$a = 1/4$  or  $1/8$  point of span (in inches)

$E = 10 \times 10^6$  p.s.i.

$I =$  moment of inertia of the mullion

$L =$  length of horizontal mullion

**PLCW-600 SERIES**  
**2 1/2" x 6"**  
**DEAD LOAD**

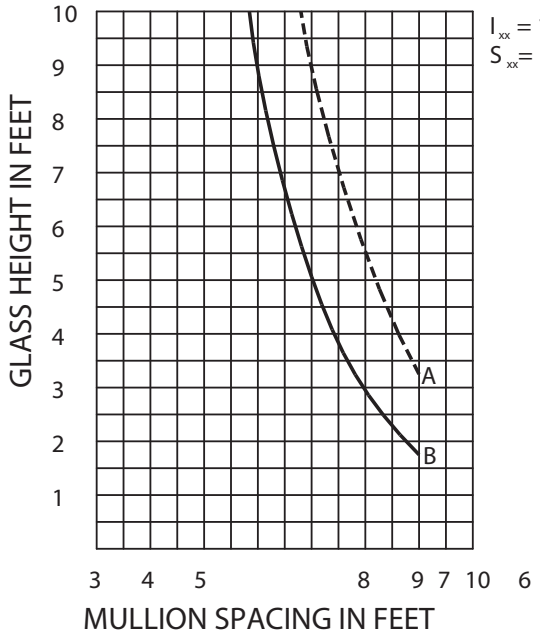

$I_{xx} = 1.428 \text{ IN}^4$   
 $S_{xx} = 1.142 \text{ IN}^3$

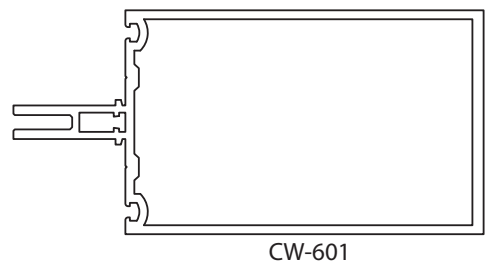

**CURVE REPRESENTATION**  
**A ( - - - - - ) = 1/8 PTS.**  
**B ( ——— ) = 1/4 PTS.**

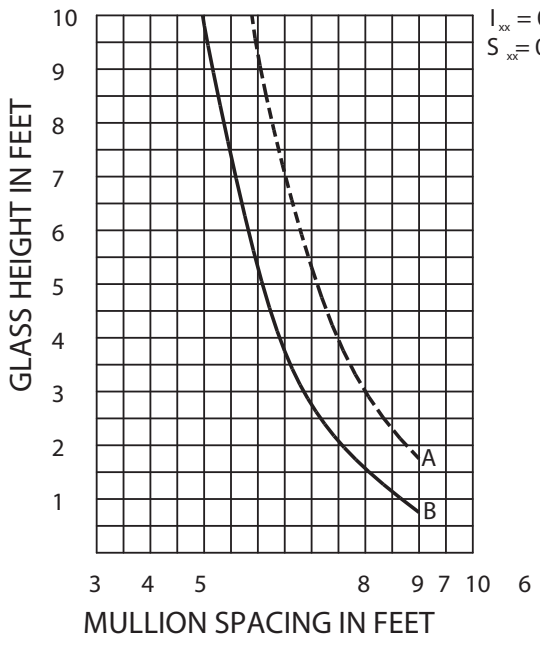

$I_{xx} = 0.786 \text{ IN}^4$   
 $S_{xx} = 0.505 \text{ IN}^3$

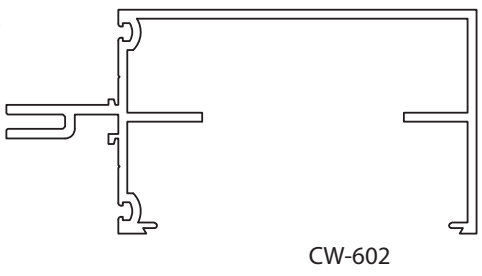



# **PLCW-700 SERIES**

**2 1/2" x 7"**

**SECTION**

# **PLCW-700 SERIES**

2 1/2" x 7"

SECTION



## ALUMINUM CURTAIN WALLS PLCW-700 SERIES

### **PART 1 GENERAL**

#### 1.1 SECTION INCLUDES

- A. Aluminum curtain walls.

#### 1.2 REFERENCES

- A. American Architectural Manufacturers Association (AAMA):
  1. AAMA/NWWDA 101/I.S. 2-97 - Voluntary Specification, Performance Requirements and Test Procedures for Air Leakage Resistance, Water Penetration Resistance, Structural Loading, Forced Entry Resistance.
  2. AAMA-501.1 - Standard Test Method for Water Penetration of Windows, Curtain Walls and Doors Using Dynamic Pressure
  3. AAMA 501.4 - Recommended Static Test Method for Evaluating Curtain Wall and Storefront Systems Subjected to Seismic and Wind Induced Interstory Drifts.
  4. AAMA 2605 - Voluntary Specification, Performance Requirements and Test Procedures for Superior Performing Organic Coatings on Aluminum Extrusions and Panels.
- B. ASTM International (ASTM):
  1. ASTM B 221 - Standard Specification for Aluminum and Aluminum-Alloy Extruded Bars, Rods, Wire, Profiles, and Tubes.
  2. ASTM E 283 - Test Method for Determining the Rate of Air Leakage Through Exterior Windows, Curtain Walls, and Doors under Specified Pressure Differences across the Specimen.
  3. ASTM E330 - Standard Test Method for Structural Performance of Exterior Windows, Doors, Skylights and Curtain Walls by Uniform Static Air Pressure Difference.
  4. ASTM E 331 - Test Method for Water Penetration of Exterior Windows, Curtain Walls, and Doors by Uniform Static Air Pressure Difference.
  5. ASTM E 1886 - Standard Test Method for Performance of Exterior Windows, Curtain Walls, Doors, and Impact Protective Systems Impacted by Missile(s) and Exposed to Cyclic Pressure Differentials.
  6. ASTM E 1996 - Standard Specification for Performance of Exterior Windows, Curtain Walls, Doors and Impact Protective Systems Impacted by Windborne Debris in Hurricanes.
- C. National Fenestration Rating Council (NFRC):
  1. NFRC-100 - Procedure for Determining Fenestration Product U-factors.
  2. NFRC-200 - Procedure for Determining Fenestration Product Solar Heat Gain Coefficient and Visible Transmittance at Normal Incidence.

#### 1.3 SUBMITTALS

- A. Submit under provisions of applicable Requirements.
- B. Product Data: Manufacturer's data sheets on each product to be used, including:
  1. Preparation instructions and recommendations.
  2. Storage and handling requirements and recommendations.

### **PLCW-700 - 1**

- 3. Installation methods.
  - C. Shop Drawings:
    - 1. Provide drawings showing each configuration.
  - D. Selection Samples: For each finish product specified, two complete sets of color chips representing manufacturer's full range of available colors and patterns.
  - E. Verification Samples: For each finish product specified, two samples, minimum size 6 inches (150 mm) square representing actual product, color, and patterns.
- 1.4 QUALITY ASSURANCE
- A. Manufacturer Qualifications: Minimum 5 year experience manufacturing similar products.
  - B. Installer Qualifications: Minimum 2 year experience installing similar products.
  - C. Mock-Up: Provide a mock-up for evaluation of surface preparation techniques and application workmanship.
    - 1. Finish areas designated by Architect.
    - 2. Do not proceed with remaining work until workmanship is approved by Architect.
    - 3. Refinish mock-up area as required to produce acceptable work.
- 1.5 PRE-INSTALLATION MEETINGS
- A. Convene minimum two weeks prior to starting work of this section.
- 1.6 DELIVERY, STORAGE, AND HANDLING
- A. Deliver and store products in manufacturer's unopened packaging bearing the brand name and manufacturer's identification until ready for installation.
  - B. Handling: Handle materials to avoid damage.
- 1.7 PROJECT CONDITIONS
- A. Maintain environmental conditions (temperature, humidity, and ventilation) within limits recommended by manufacturer for optimum results. Do not install products under environmental conditions outside manufacturer's recommended limits.
- 1.8 SEQUENCING
- A. Ensure that products of this section are supplied to affected trades in time to prevent interruption of construction progress.

## **PART 2 PRODUCTS**

- A. Acceptable Manufacturer: PRL Glass Systems, Inc., which is located at: 13644 Nelson Ave.; City of Industry, CA 91746; Toll Free Tel: 800-433-7044; Fax: 626-968-9256; Email:[request info \(info@prlglass.com\)](mailto:requestinfo@prlglass.com); Web:[prlglass.com](http://prlglass.com)
  - B. Substitutions: Not permitted.
  - C. Requests for substitutions will be considered in accordance with provisions of Section 01 60 00 - Product Requirements.
- 2.2 CURTAIN WALLS

- A. Frame : 2-1/2 inches (64 mm) face width:
  - 1. Glazing: Structural glaze verticals.
  - 2. Glazing: Structural glaze horizontals.
  
- A. **7 Inches (178 mm) Depth:**
  - 1. **Product: PLCW-700 as manufactured by PRL Glass Systems, Inc.**
  - 2.
    - a. Air infiltration: Limit air leakage through fixed glazing and frames to 0.026 cfm/ft<sup>2</sup>/min (0.01 L/s/m<sup>2</sup>) when tested in accordance with ASTM E-283-04 at a cross pressure of 6.24 psf (0.30 kPa).
    - b. Water Penetration under Static Pressure: System shall not evidence uncontrolled water penetration at a cross pressure of 15 psf (103 kPa) when tested in accordance with ASTM-E331-00.
    - c. Water Penetration under Dynamic Pressure: System shall not evidence uncontrolled water penetration at a cross pressure of 15 psf (103 kPa) when tested in accordance with AAMA-501.1-05.
    - d. Design Wind Load: Limit mullion deflection to L/175 up to 13 feet-6 inches (4115 mm) and L/240+1/4 inch (6 mm) for spans above 13 feet-6 inches (4115 mm) when measured in accordance with ASTM E330-02 at a cross pressure of 40 psf (276 kPa).
    - e. Seismic Racking: Compliance that system can accommodate a lateral movement of 3/4 inch (19 mm) when tested to AAMA 501.4-00.
    - f. Thermal Conductance: Whole product rating shall be determined in accordance with NFRC-100. Show that specified product can achieve U-factor of no greater than 0.37 (Values based on structural glaze verticals, and insulated glass comprising exterior light of 1/4 inch (6 mm) bronze, 1/2 inch (13 mm) space with argon fill and an interior light of 1/4 inch (6 mm) SunGuard SNX 62/27).
    - g. Solar Heat Gain: Whole product rating shall be determined in accordance with NFRC-200. Show that the specified product can achieve a SHGC of no greater than 0.36. (Values based on structural glaze verticals, and insulated glass comprising exterior light of 1/4 inch (6 mm) bronze, 1/2 inch (13 mm) space with argon fill and an interior light of 1/4 inch (6 mm) SunGuard SNX 62/27).

### 2.3 MATERIALS

- A. Material: Frames, assembly clips, trims and miscellaneous extrusions shall be extruded from Aluminum 6063-T6 alloy.
- B. Glazing Gaskets:
  - 1. Compression type gaskets. Extruded EPDM (Ethylene Propylene Diene Monomer) push in place gasket. Dense 60 Durometer Shore "A" - ASTM C864 Option II
  - 2. Structural silicone compatible gasket: true silicone gasket -70 Durometer Shore "A", complying with ASTM C1115, Type C.
- C. Thermal isolators: extruded rigid Geon complying with AAMA-303 and ASTM-D-1784-9.
- D. End Dams: Pre-molded end dams made from closed cell EPDM (Ethylene Propylene Diene Monomer) sponge to ASTM C509.

### 2.4 SUN CONTROL:

- A. Vertical Sunshade:
- B. Horizontal Sunshade:
- C. Light Shelf Adaptable:

## PLCW-700 - 3

## 2.5 FINISH

- A. Class II clear anodized aluminum shall conform to AA-M12-C22-A31.
- B. Class I clear anodized aluminum shall conform to AA-M12-C22-A41.
- C. Class II color anodized aluminum shall conform to AA-M12-C22-A34.
  - 1. Color: Champagne.
  - 2. Color: Light Bronze.
  - 3. Color: Medium Bronze.
  - 4. Color: Dark Bronze.
  - 5. Color: Black.
- D. Class I color anodized aluminum shall conform to AA-M12-C22-A44.
  - 1. Color: Champagne.
  - 2. Color: Light Bronze.
  - 3. Color: Medium Bronze.
  - 4. Color: Dark Bronze.
  - 5. Color: Black.
- E. Fluorocarbon finish complying with AAMA 2605.
  - 1. Resin: 70% PVDF resin shall be Kynar using Kynar500/Hylar5000.
  - 2. Cleaned and pretreated with chromium phosphate
  - 3. Coat extrusions with approved primers to minimum dry film thickness of 0.20 mil (.0051 mm).
  - 4. Color coat shall be a minimum dry film thickness of 1.0 mil (.025 mm).
  - 5. Approved Coating Manufactures:
    - a. PPG Industries
    - b. Valspar Corporation

## **EXECUTION**

- A. Do not begin installation until substrates have been properly prepared.
- B. If substrate preparation is the responsibility of another installer, notify Architect of unsatisfactory preparation before proceeding.

## 3.2 PREPARATION

- A. Clean surfaces thoroughly prior to installation.
- B. Prepare surfaces using the methods recommended by the manufacturer for achieving the best result for the substrate under the project conditions.

## 3.3 INSTALLATION

- A. Install in accordance with manufacturer's instructions.

## 3.4 FIELD QUALITY CONTROL

- A. Owner will engage an independent AAMA approved testing agency.
- B. Conduct test under the supervision of and in the presence of the Owner, Architect, and Construction Manager.
- C. Test wall in accordance with AAMA 501.2-94.

### 3.5 PROTECTION

- A. Protect installed products until completion of project.
- B. Touch-up, repair or replace damaged products before Substantial Completion.

END OF SECTION





**PLCW-700 SERIES**  
**2 1/2" x 7"**  
**1/4 SCALE**

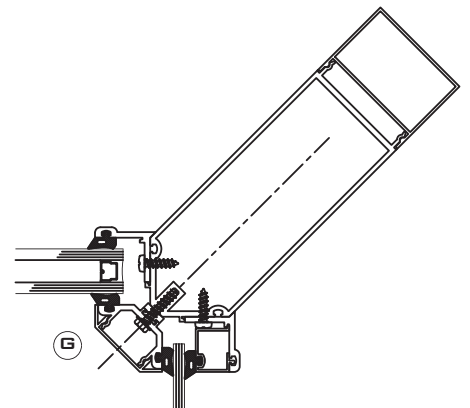
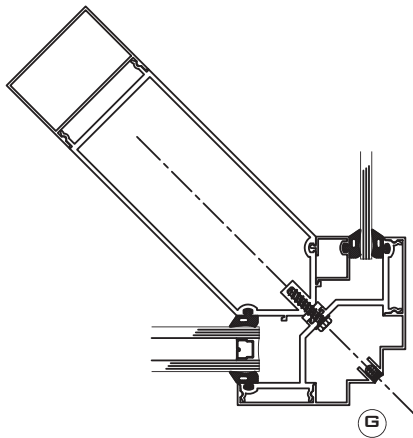
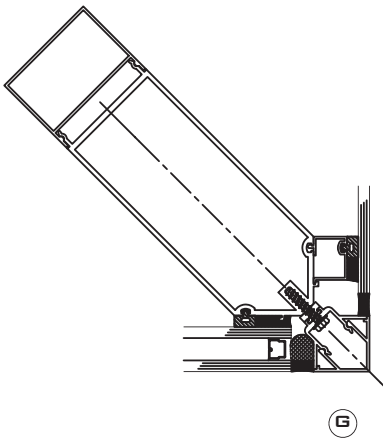
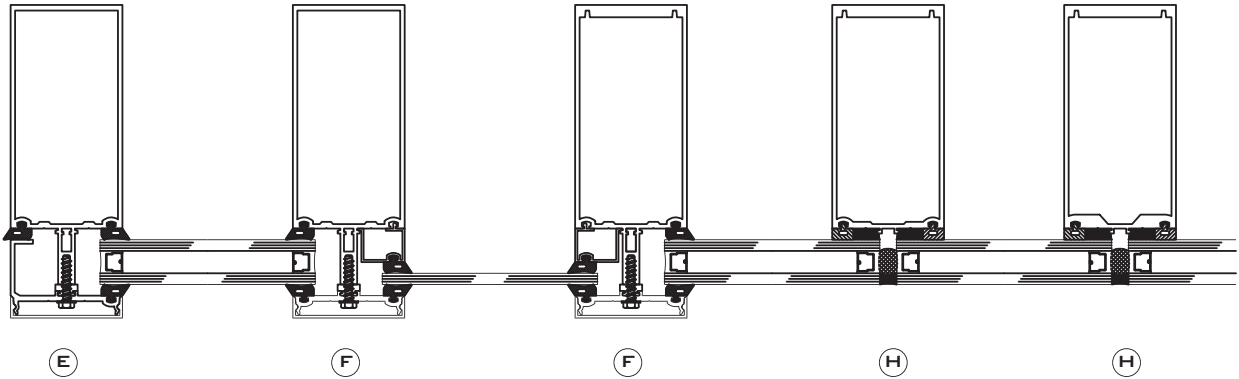
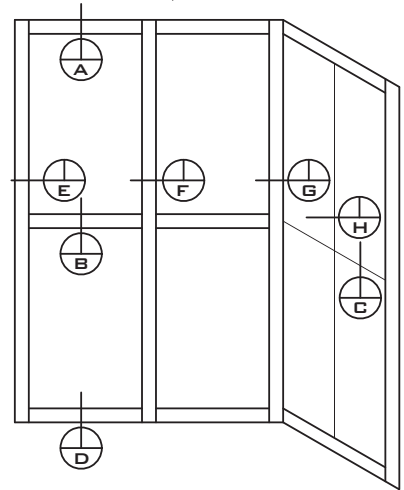
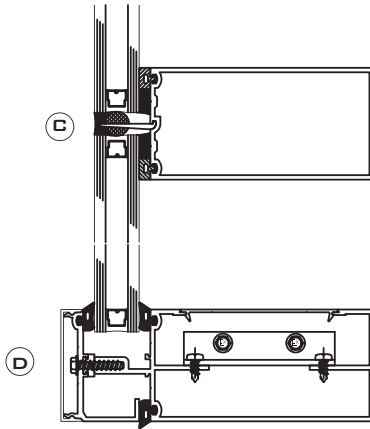
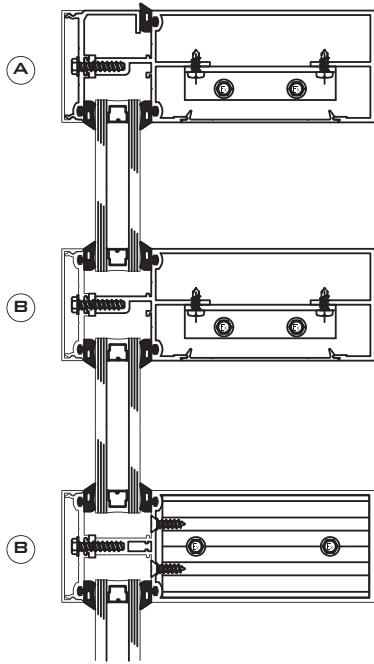

**PLCW-700 - 6**

14760 Don Julian Rd.  
 Industry, CA 91746

ph: (877) 775-2586  
 fx: (877) 274-8800

www.prlaluminum.com  
 sales@prlaluminum.com

**PLCW-700 SERIES**  
**2 1/2" x 7"**  
**1/4 SCALE**

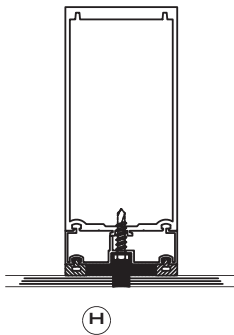
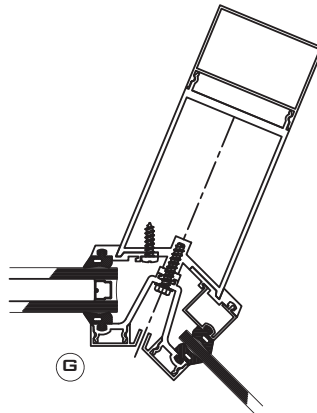
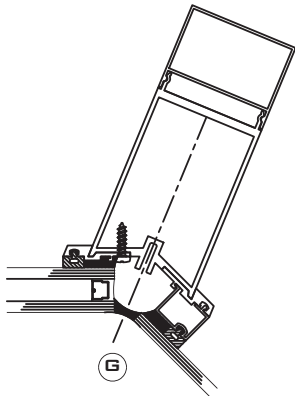
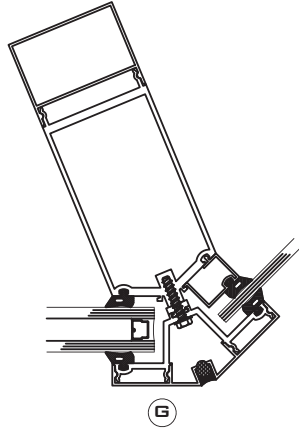
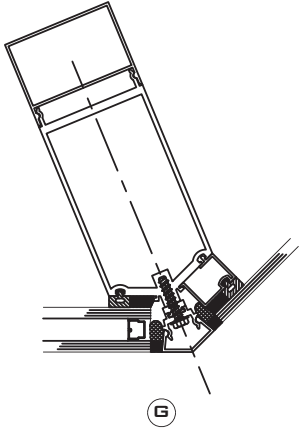

ph: (877) 775-2586  
fx: (877) 274-8800

**PLCW-700 - 7**  
14760 Don Julian Rd.  
Industry, CA 91746

[www.prlaluminum.com](http://www.prlaluminum.com)  
[sales@prlaluminum.com](mailto:sales@prlaluminum.com)

**PLCW-700 SERIES**  
**2 1/2" x 7"**  
**FULL SCALE**

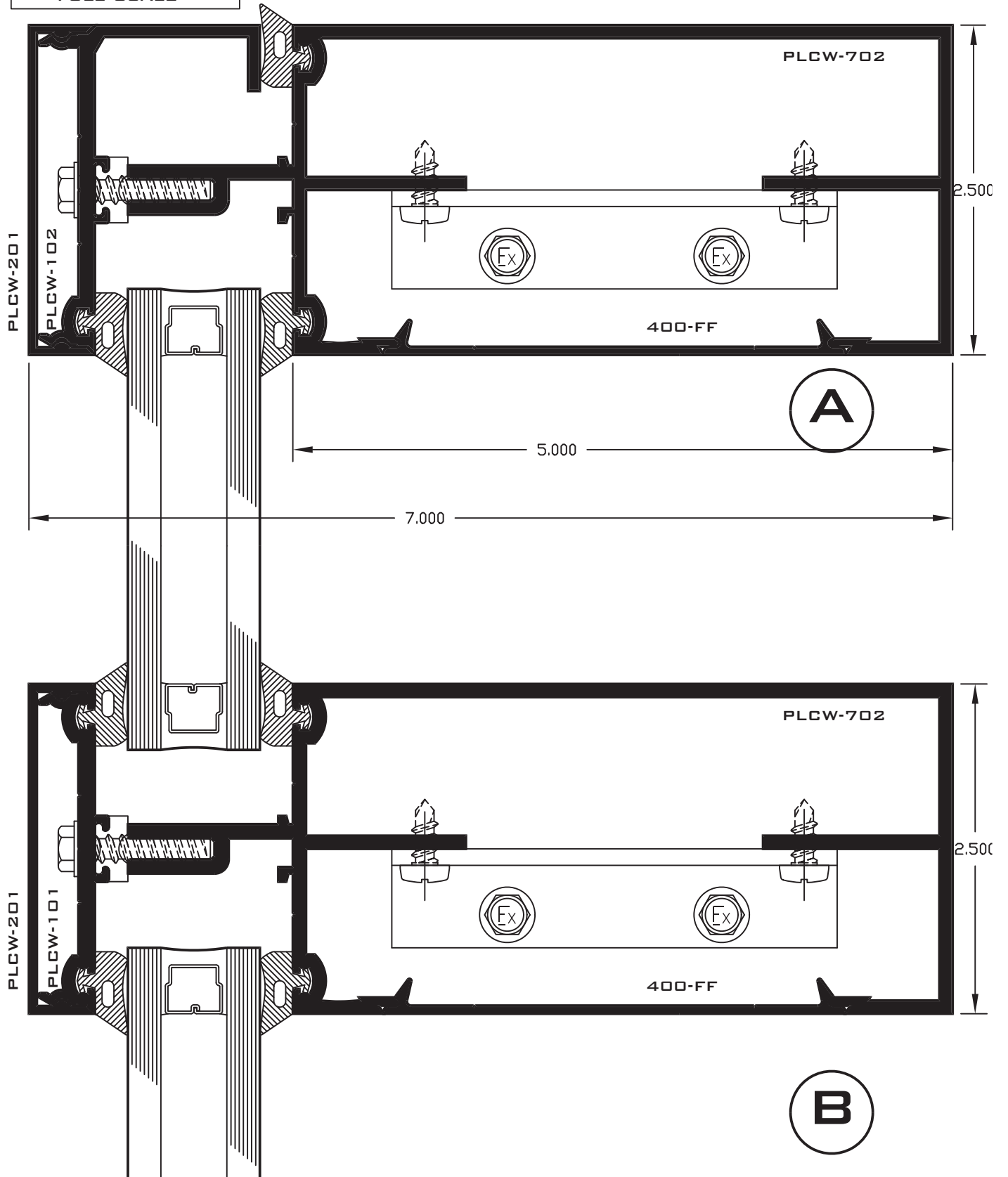

**PLCW-700 - 8**

14760 Don Julian Rd.  
Industry, CA 91746

ph: (877) 775-2586  
fx: (877) 274-8800

[www.prlaluminum.com](http://www.prlaluminum.com)  
[sales@prlaluminum.com](mailto:sales@prlaluminum.com)

**PLCW-700 SERIES**  
**2 1/2" x 7"**  
**FULL SCALE**

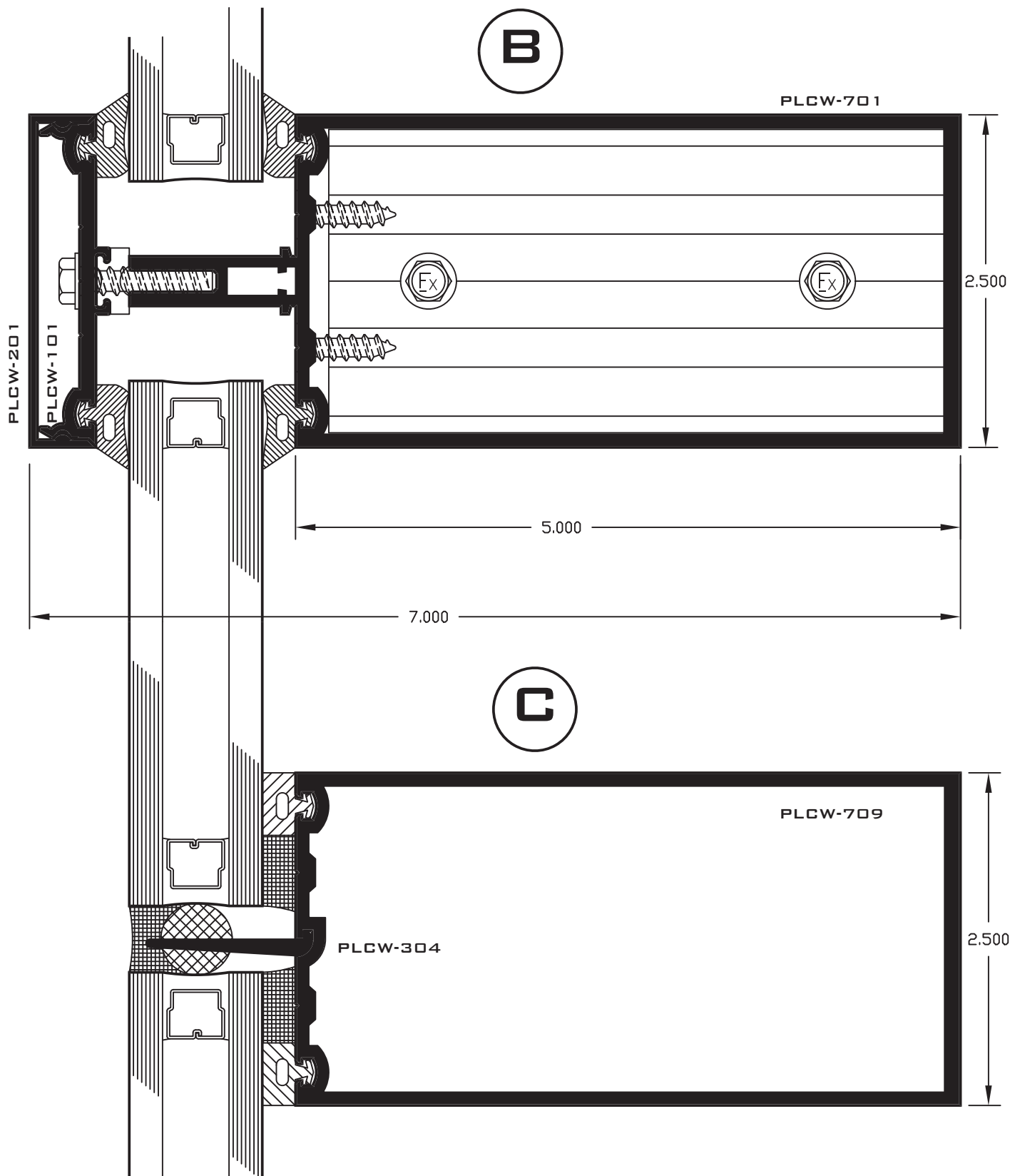

**PLCW-700 - 9**

14760 Don Julian Rd.  
Industry, CA 91746

ph: (877) 775-2586  
fx: (877) 274-8800

[www.prlaluminum.com](http://www.prlaluminum.com)  
[sales@prlaluminum.com](mailto:sales@prlaluminum.com)

PLCW-700 SERIES  
2 1/2" x 7"  
FULL SCALE

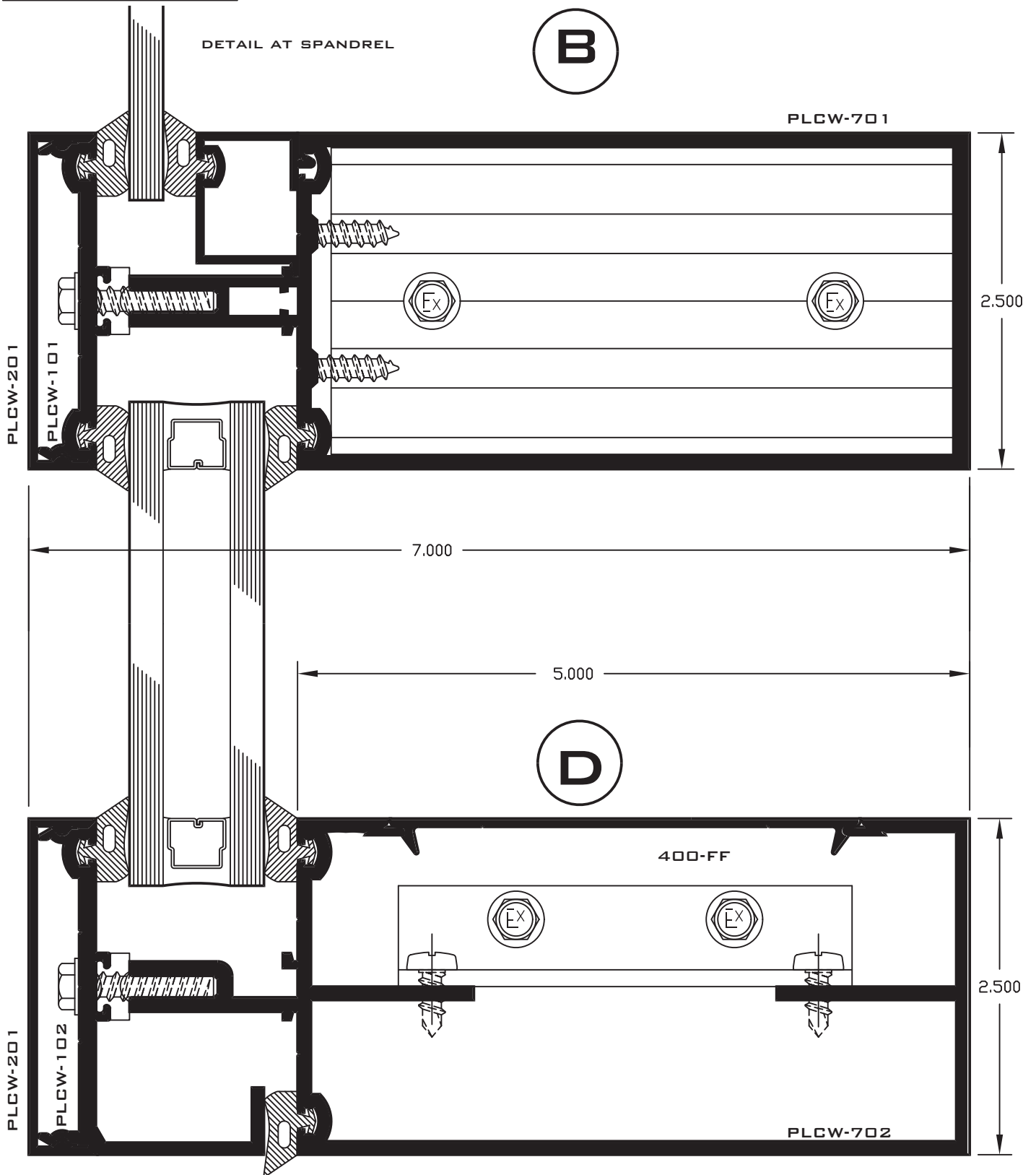

PLCW-700 - 10

14760 Don Julian Rd.  
Industry, CA 91746

ph: (877) 775-2586  
fx: (877) 274-8800

www.prlaluminum.com  
sales@prlaluminum.com

**PLCW-700 SERIES**  
**2 1/2" x 7"**  
**FULL SCALE**

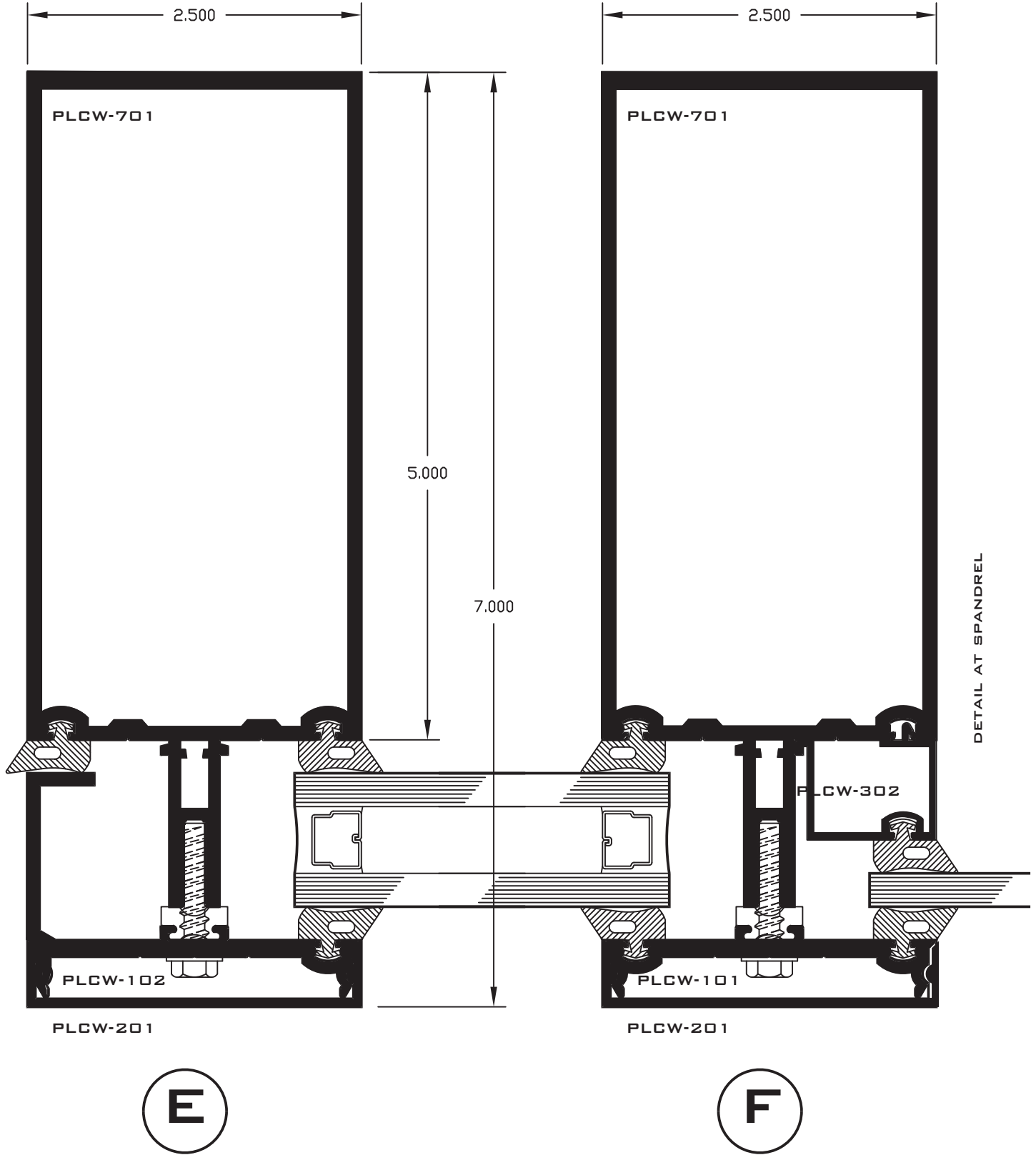

**PLCW-700 - 11**  
14760 Don Julian Rd.  
Industry, CA 91746

ph: (877) 775-2586  
fx: (877) 274-8800

[www.prlaluminum.com](http://www.prlaluminum.com)  
[sales@prlaluminum.com](mailto:sales@prlaluminum.com)

**PLCW-700 SERIES**  
**2 1/2" x 7"**  
**FULL SCALE**

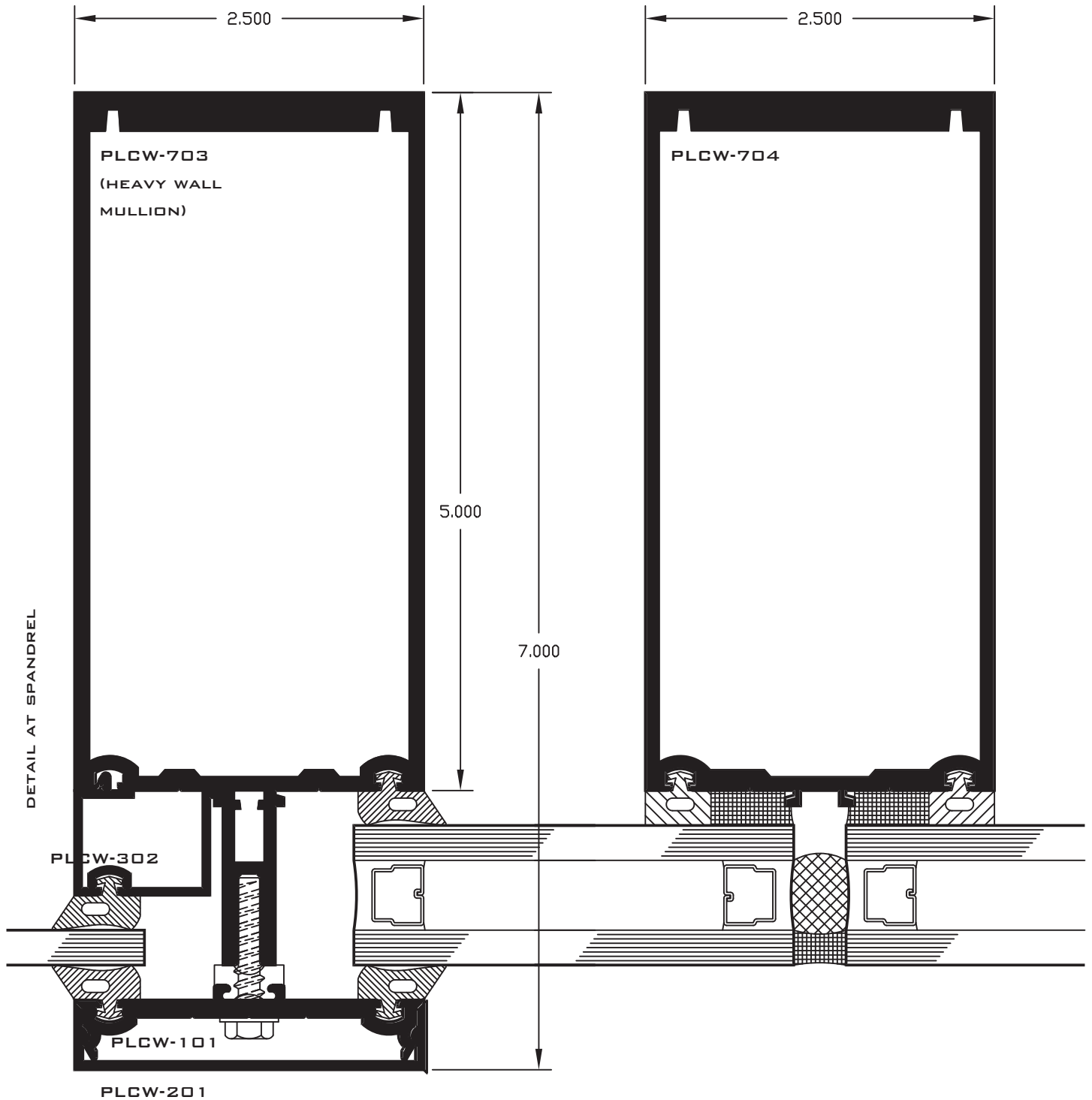

ph: (877) 775-2586  
fx: (877) 274-8800

**PLCW-700 - 12**  
14760 Don Julian Rd.  
Industry, CA 91746

[www.prlaluminum.com](http://www.prlaluminum.com)  
[sales@prlaluminum.com](mailto:sales@prlaluminum.com)

**PLCW-700 SERIES**  
**2 1/2" x 7"**  
**FULL SCALE**

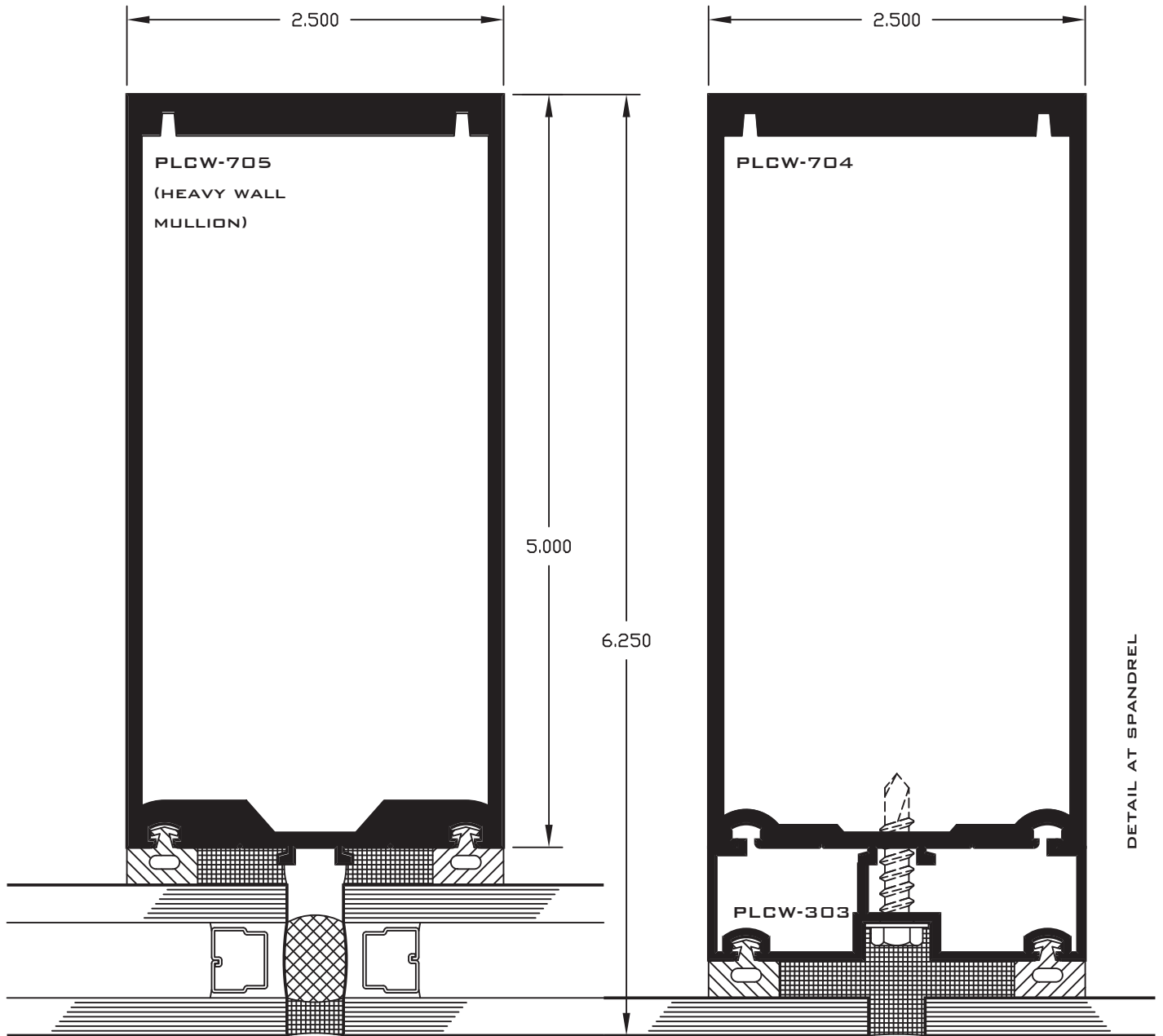

ph: (877) 775-2586  
fx: (877) 274-8800

**PLCW-700 - 13**  
14760 Don Julian Rd.  
Industry, CA 91746

[www.prlaluminum.com](http://www.prlaluminum.com)  
[sales@prlaluminum.com](mailto:sales@prlaluminum.com)



**PLCW-700 SERIES**  
**2 1/2" x 7"**  
**FULL SCALE**

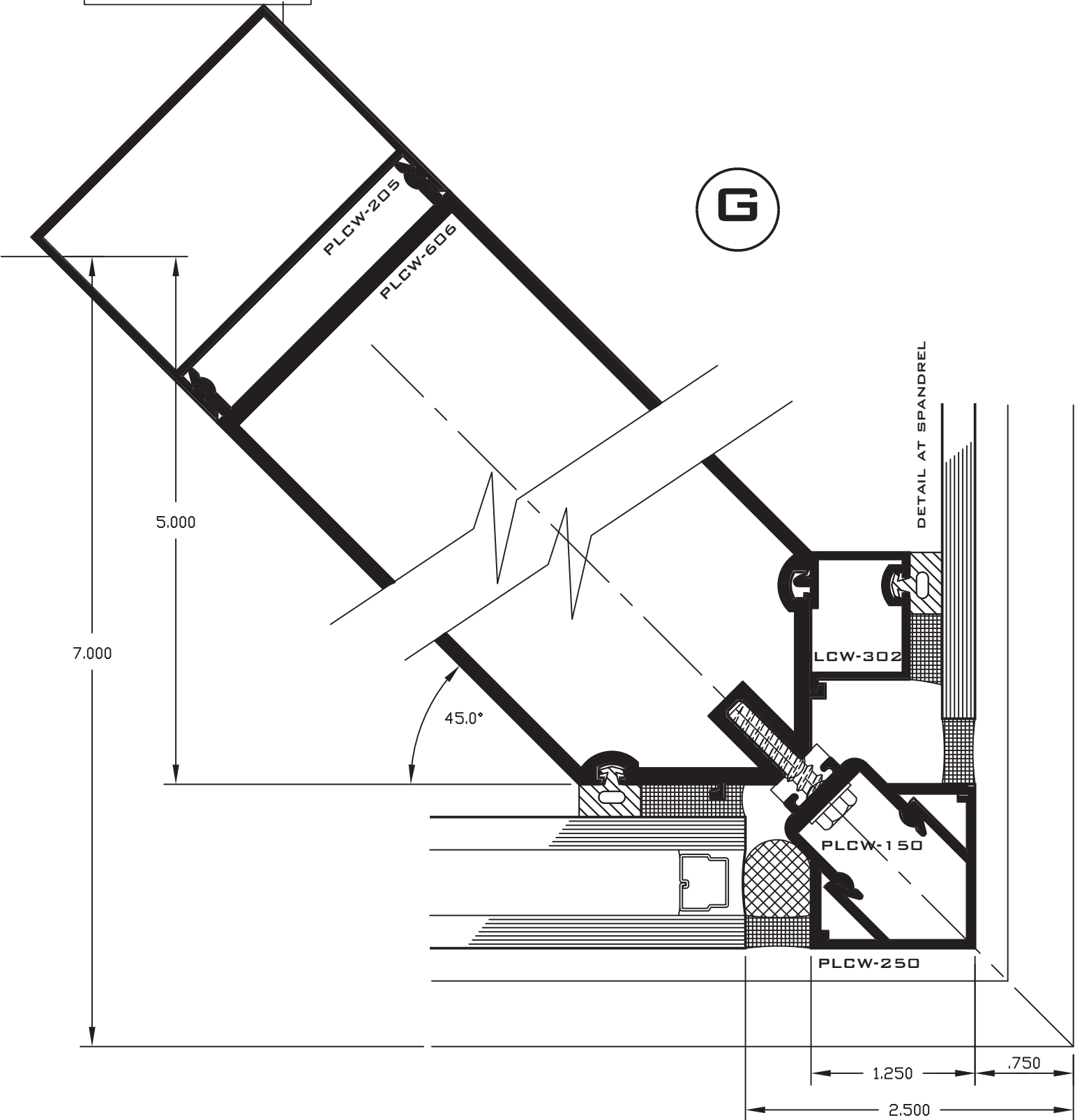

ph: (877) 775-2586  
fx: (877) 274-8800

**PLCW-700 - 14**  
14760 Don Julian Rd.  
Industry, CA 91746

[www.prlaluminum.com](http://www.prlaluminum.com)  
[sales@prlaluminum.com](mailto:sales@prlaluminum.com)

**PLCW-700 SERIES**  
**2 1/2" x 7"**  
**FULL SCALE**



**G**

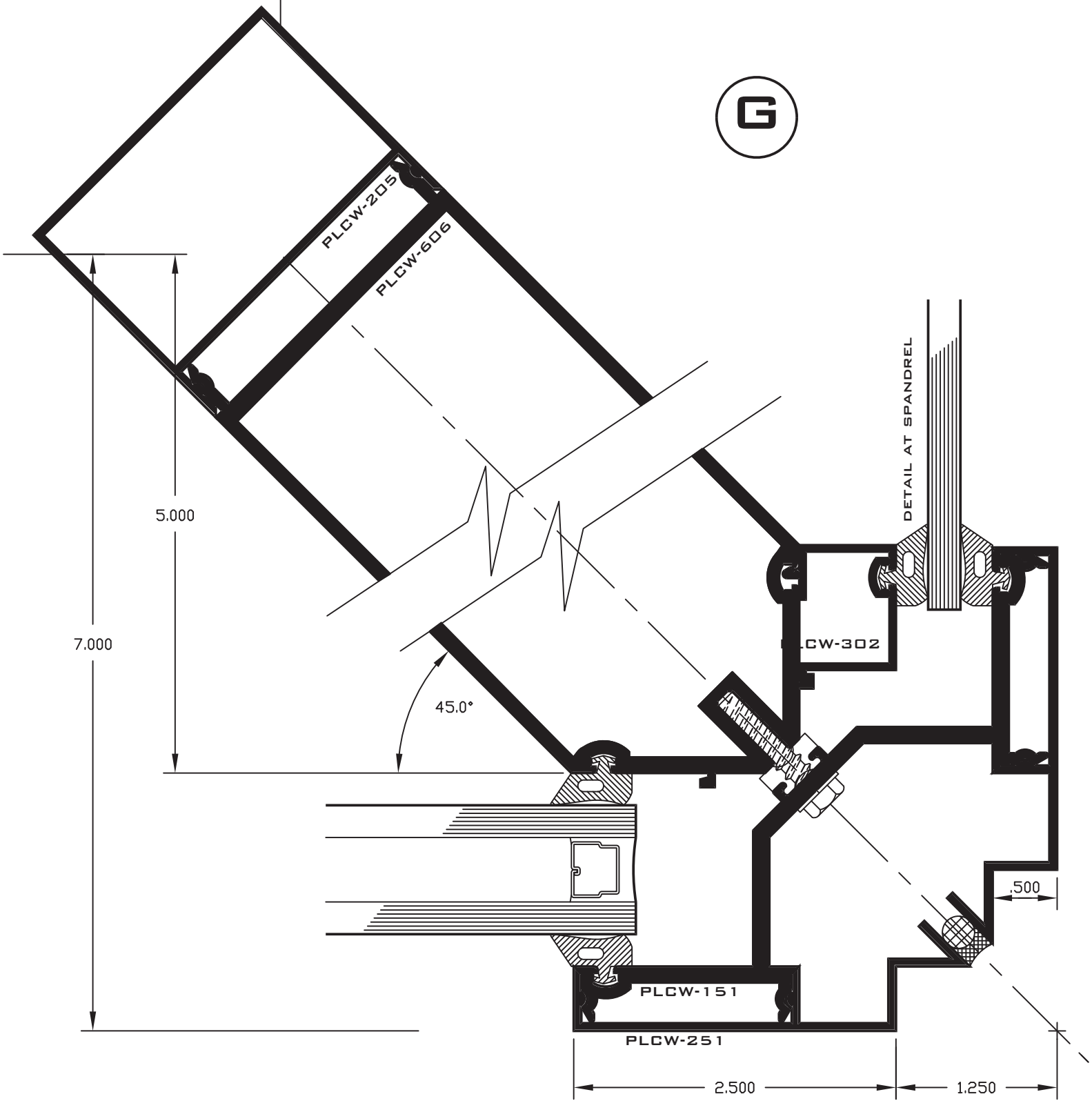

ph: (877) 775-2586  
fx: (877) 274-8800

**PLCW-700 - 15**  
14760 Don Julian Rd.  
Industry, CA 91746

[www.prlaluminum.com](http://www.prlaluminum.com)  
[sales@prlaluminum.com](mailto:sales@prlaluminum.com)

**PLCW-700 SERIES**  
**2 1/2" x 7"**  
**FULL SCALE**

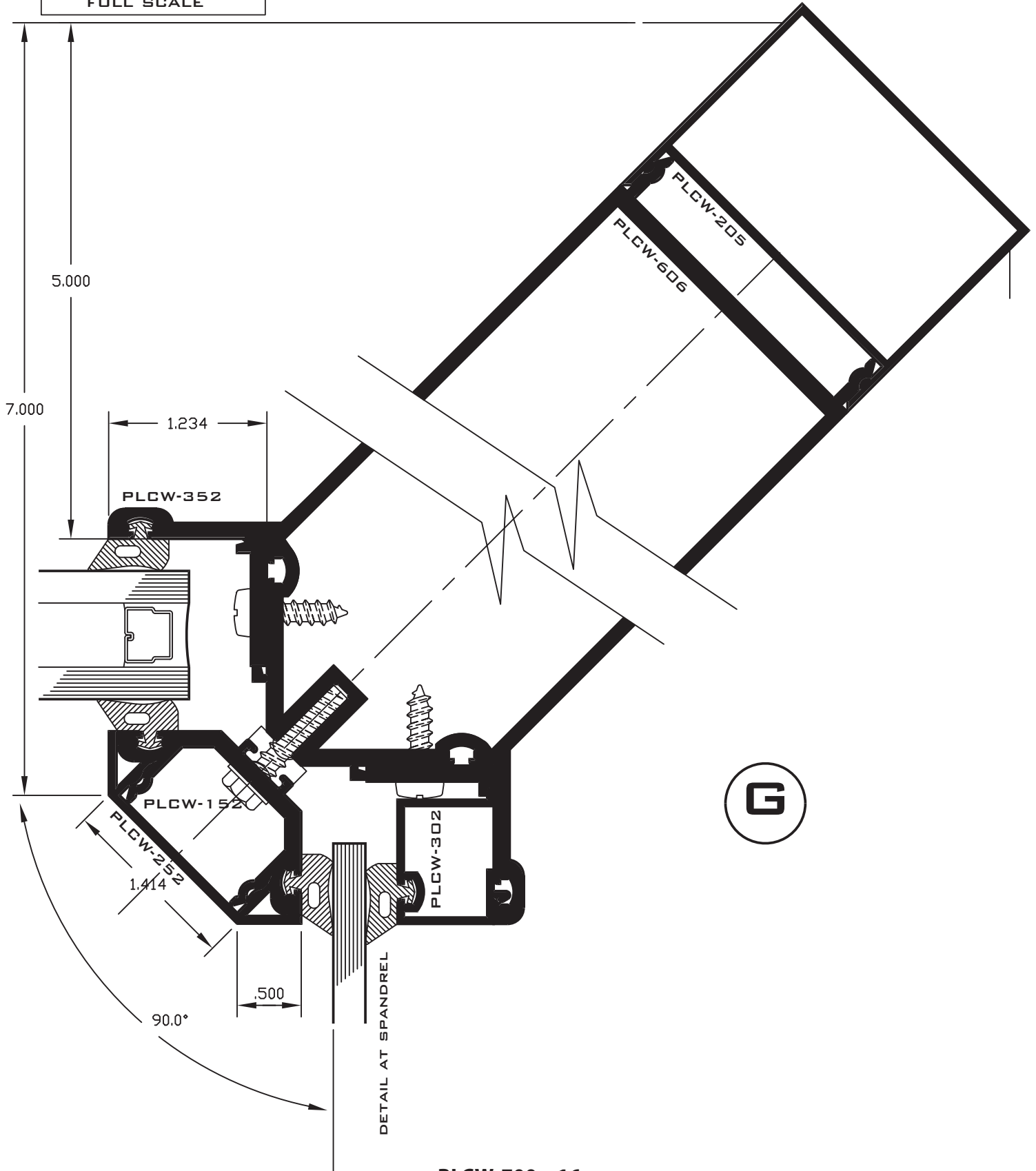

ph: (877) 775-2586  
fx: (877) 274-8800

**PLCW-700 - 16**  
14760 Don Julian Rd.  
Industry, CA 91746

[www.prlaluminum.com](http://www.prlaluminum.com)  
[sales@prlaluminum.com](mailto:sales@prlaluminum.com)

**PLCW-700 SERIES**  
**2 1/2" x 7"**  
**FULL SCALE**

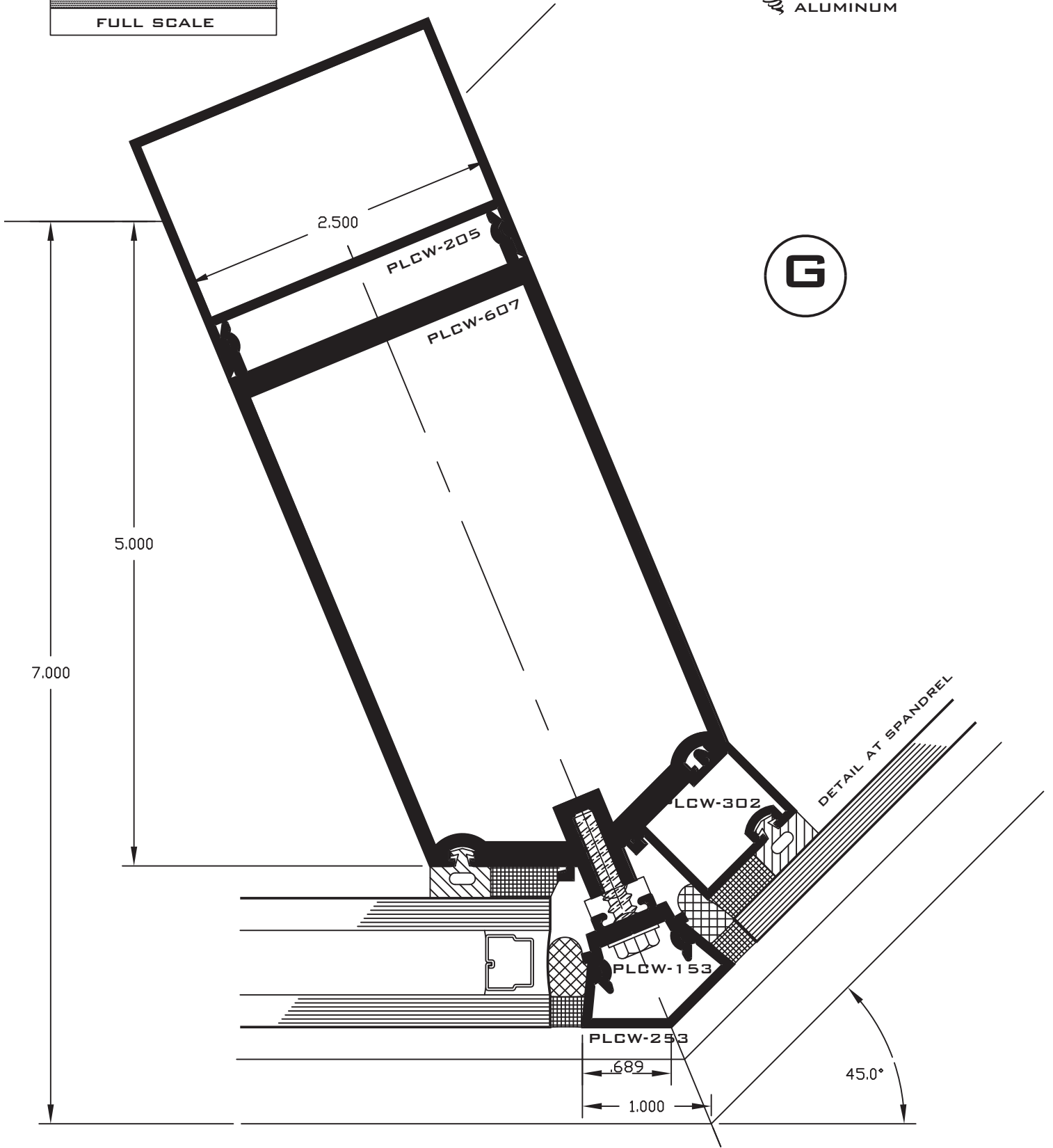

**PLCW-700 - 17**

14760 Don Julian Rd.  
Industry, CA 91746

ph: (877) 775-2586  
fx: (877) 274-8800

[www.prlaluminum.com](http://www.prlaluminum.com)  
[sales@prlaluminum.com](mailto:sales@prlaluminum.com)

**PLCW-700 SERIES**  
**2 1/2" x 7"**  
**FULL SCALE**

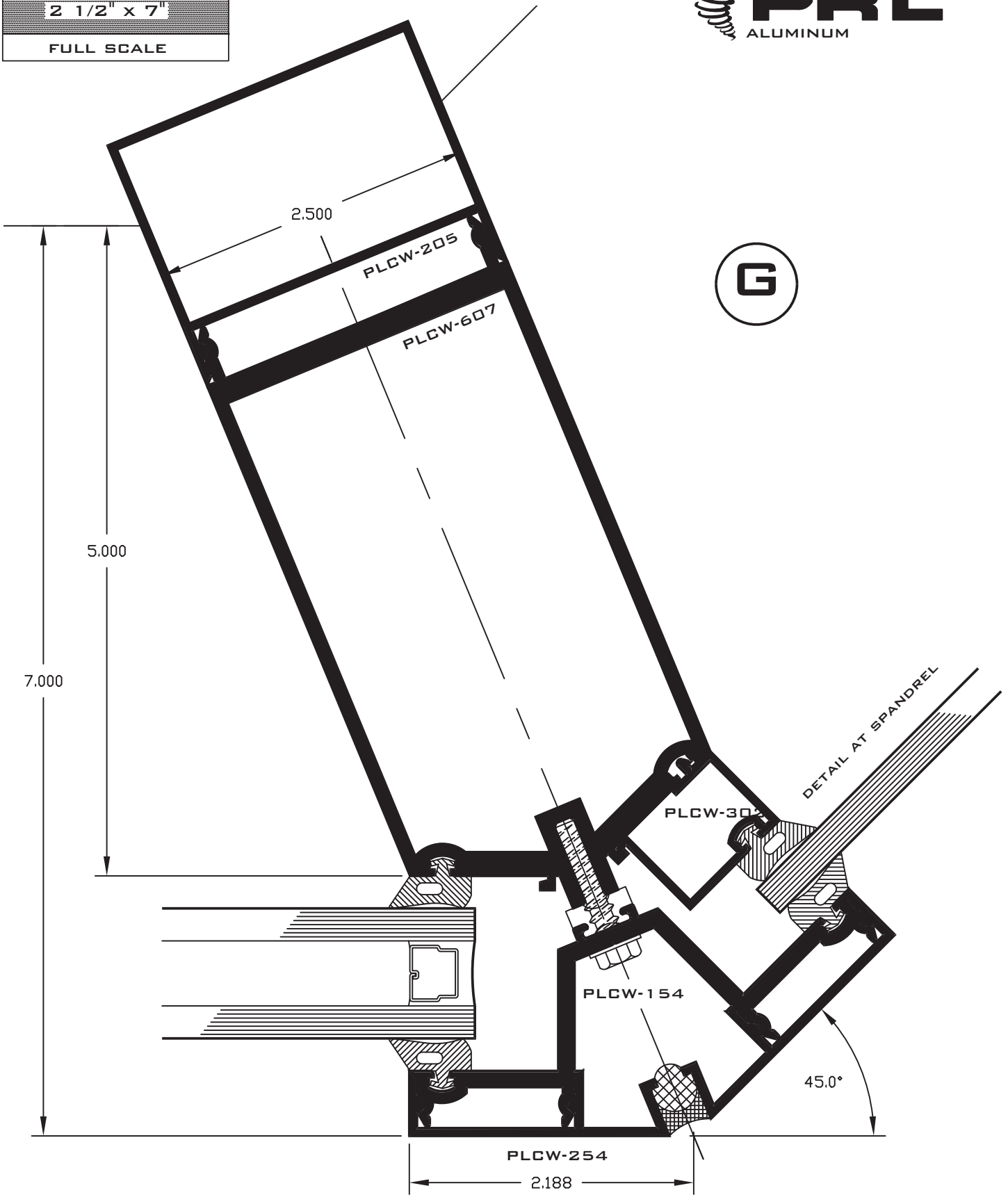

ph: (877) 775-2586  
fx: (877) 274-8800

**PLCW-700 - 18**  
14760 Don Julian Rd.  
Industry, CA 91746

[www.prlaluminum.com](http://www.prlaluminum.com)  
[sales@prlaluminum.com](mailto:sales@prlaluminum.com)

**PLCW-700 SERIES**  
**2 1/2" x 7"**  
**FULL SCALE**

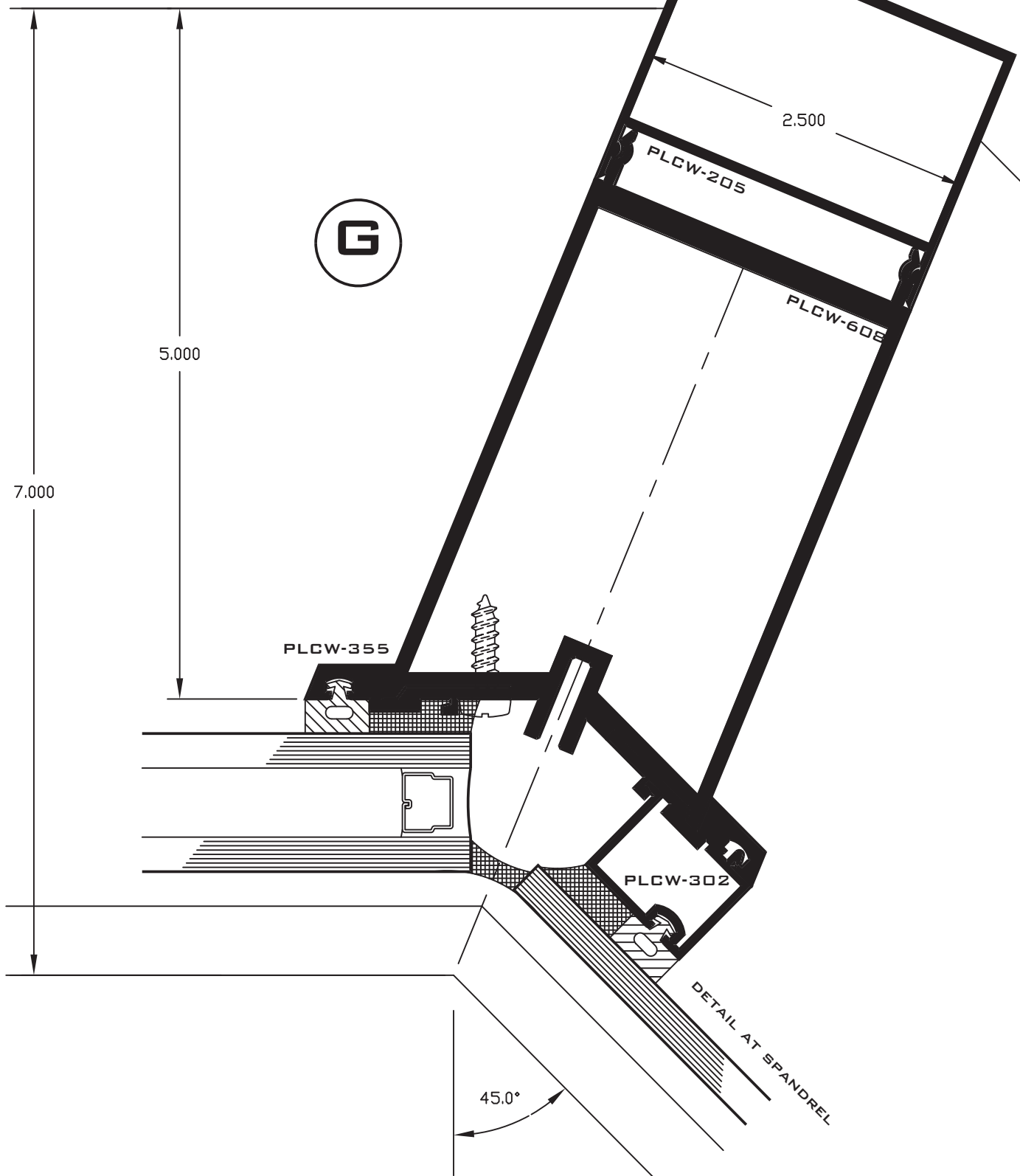

**PLCW-700 - 19**  
14760 Don Julian Rd.  
Industry, CA 91746

ph: (877) 775-2586  
fx: (877) 274-8800

[www.prlaluminum.com](http://www.prlaluminum.com)  
[sales@prlaluminum.com](mailto:sales@prlaluminum.com)

**PLCW-700 SERIES**  
**2 1/2" x 7"**  
**FULL SCALE**

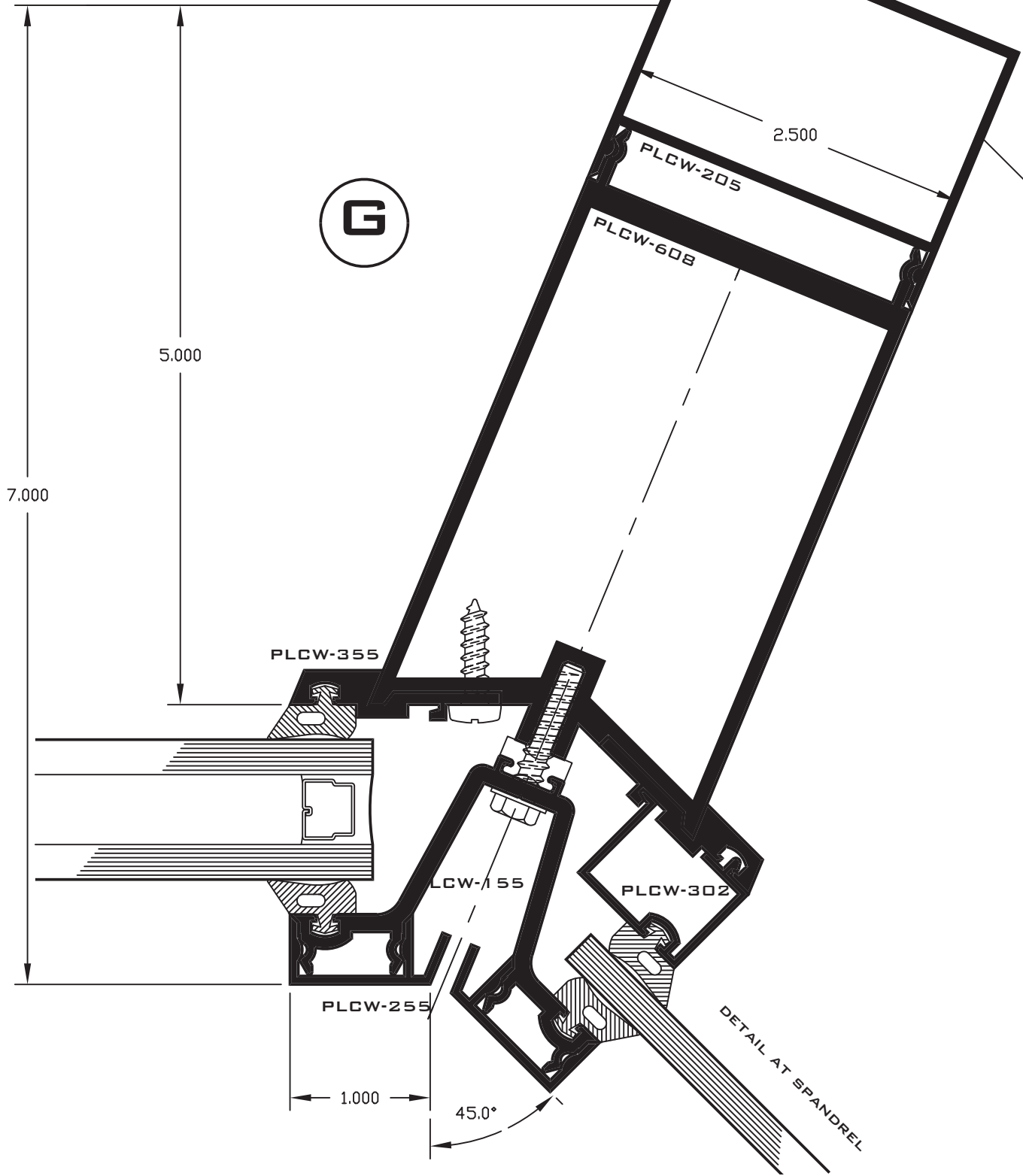

**PLCW-700 - 20**  
14760 Don Julian Rd.  
Industry, CA 91746

ph: (877) 775-2586  
fx: (877) 274-8800

[www.prlaluminum.com](http://www.prlaluminum.com)  
[sales@prlaluminum.com](mailto:sales@prlaluminum.com)



## wind load design

Mullion deflection is limited per AAMA TIR-A11-04  
deflection is limited to L/175 for spans up to 13'-6"  
and L/240 for spans beyond 13'-6"

allowable stress for 6063-T6 aluminum alloy = 15000 p.s.i.  
allowable stress for A-36 steel = 21600 p.s.i.

maximum deflection was based on the following equation:

$$\Delta = \frac{5WL^3}{384EI}$$

maximum bending moment was based on the following equation:

$$M = \frac{WL}{8}$$

assumptions:

W = total uniform load

L = length of mullion between anchors

E =  $10 \times 10^6$  p.s.i.

I = moment of inertia of the mullion

M = maximum bending moment

\* mullions are assumed to have equal size glass lights each side

check with local code requirements for acceptance of AAMA TIR-A11



**PLCW-700 SERIES**  
**2 1/2" x 7"**  
**WIND LOAD**

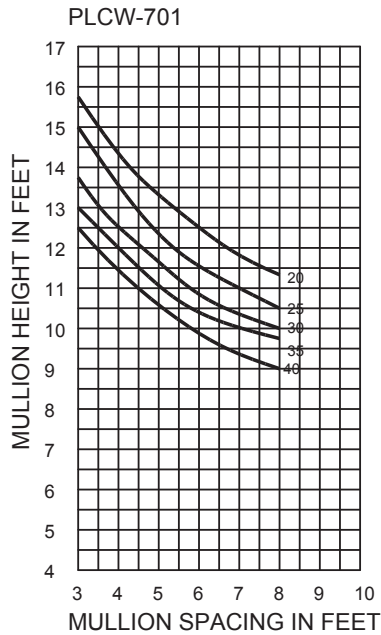

$I_{xx} = 7.771 \text{ IN}^4$   
 $S_{xx} = 2.359 \text{ IN}^3$

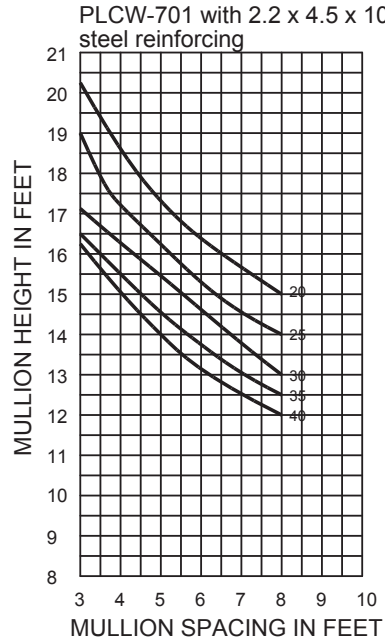
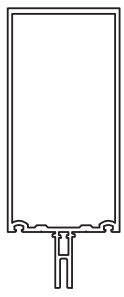

$I_{xx} = 18.044 \text{ IN}^4$

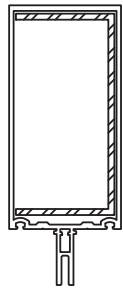

**CURVE REPRESENTATION**  
 A = 20 P.S.F.  
 B = 25 P.S.F.  
 C = 30 P.S.F.  
 D = 35 P.S.F.  
 E = 40 P.S.F.

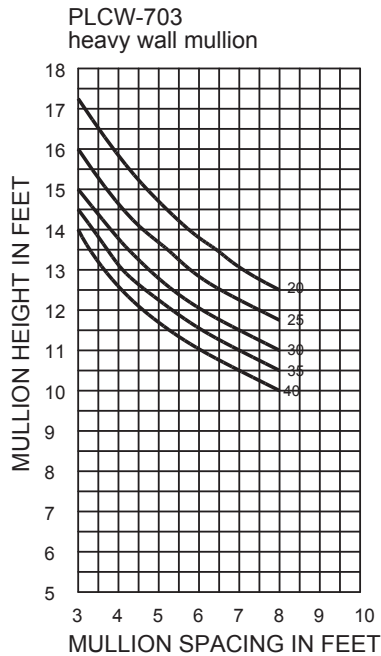

$I_{xx} = 10.558 \text{ IN}^4$   
 $S_{xx} = 2.948 \text{ IN}^3$

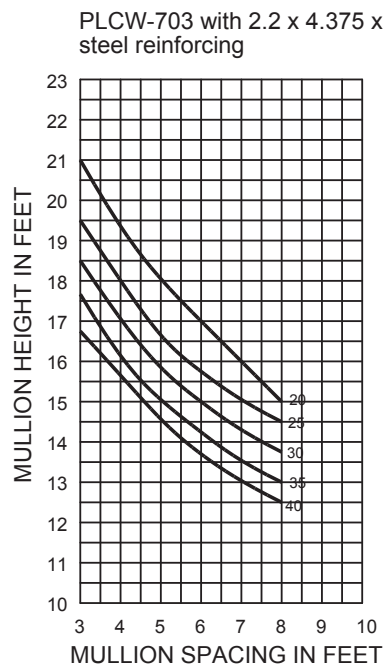
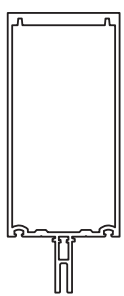

$I_{xx} = 20.214 \text{ IN}^4$

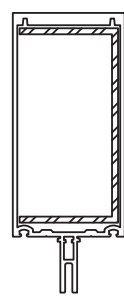

**PLCW-700 - 22**

ph: (877) 775-2586  
 fx: (877) 274-8800

14760 Don Julian Rd.  
 Industry, CA 91746

www.prlaluminum.com  
 sales@prlaluminum.com

**PLCW-700 SERIES**  
**2 1/2" x 7"**  
**WIND LOAD**

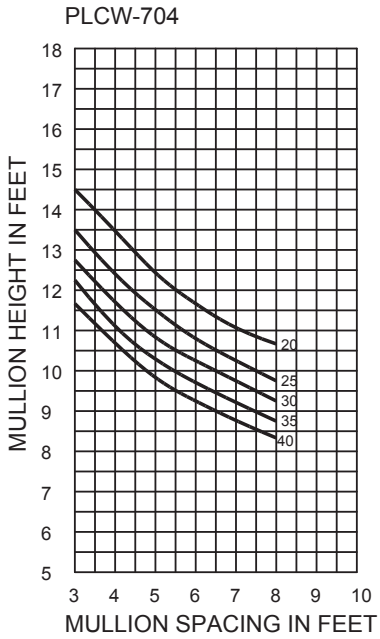

$I_{xx} = 6.294 \text{ IN}^4$   
 $S_{xx} = 2.372 \text{ IN}^3$

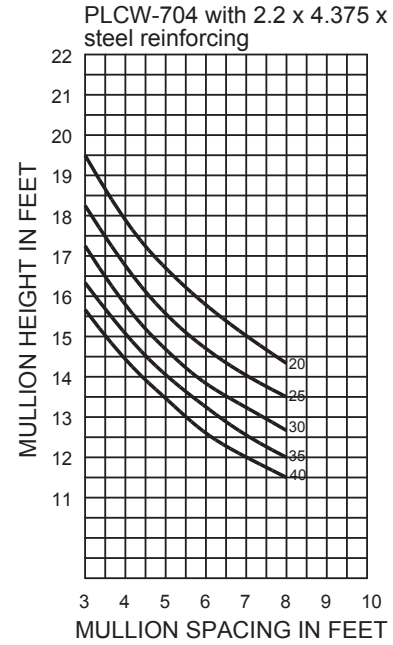
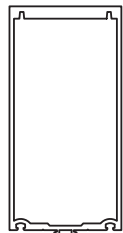

$I_{xx} = 15.950 \text{ IN}^4$

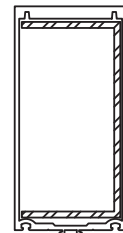

**CURVE REPRESENTATION**  
 A = 20 P.S.F.  
 B = 25 P.S.F.  
 C = 30 P.S.F.  
 D = 35 P.S.F.  
 E = 40 P.S.F.

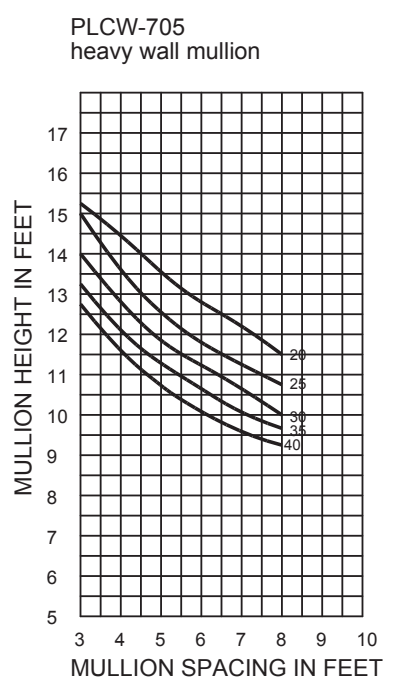

$I_{xx} = 8.283 \text{ IN}^4$   
 $S_{xx} = 3.167 \text{ IN}^3$

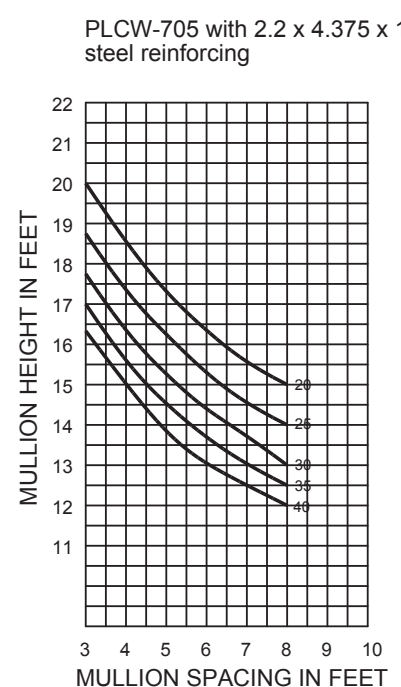
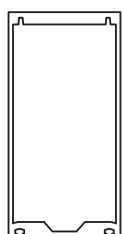

$I_{xx} = 17.939 \text{ IN}^4$

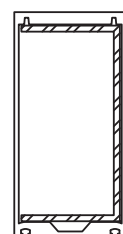

**PLCW-700 - 23**

ph: (877) 775-2586  
 fx: (877) 274-8800

14760 Don Julian Rd.  
 Industry, CA 91746

www.prlaluminum.com  
 sales@prlaluminum.com

**PLCW-700 SERIES**  
**2 1/2" x 7"**  
**WIND LOAD**



PLCW-606  
 90° inside/outside corner

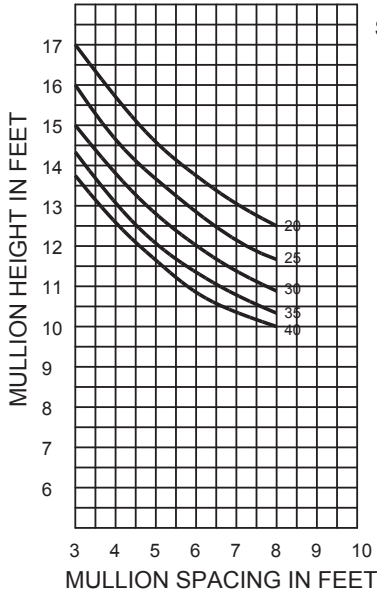

$I_{xx} = 10.306 \text{ IN}^4$   
 $S_{xx} = 2.943 \text{ IN}^3$

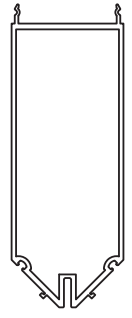

PLCW-606 with 2.2 x 5.0 x 10g  
 steel reinforcing

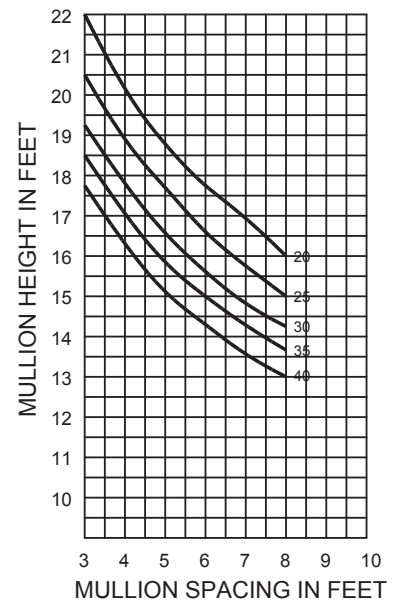

$I_{xx} = 23.483 \text{ IN}^4$

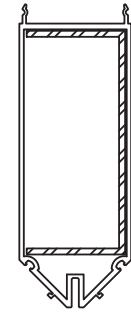

**CURVE REPRESENTATION**  
 A = 20 P.S.F.  
 B = 25 P.S.F.  
 C = 30 P.S.F.  
 D = 35 P.S.F.  
 E = 40 P.S.F.

PLCW-607  
 135° outside corner mullion

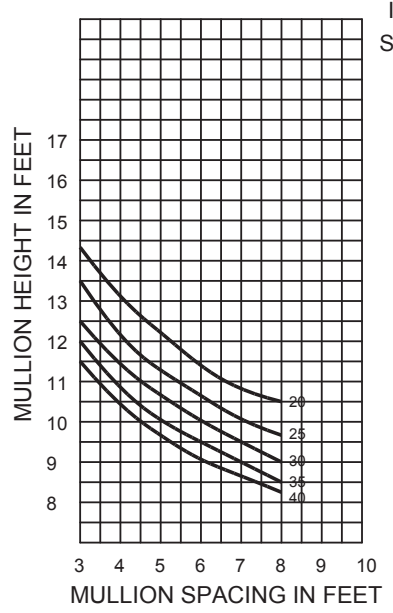

$I_{xx} = 5.915 \text{ IN}^4$   
 $S_{xx} = 2.247 \text{ IN}^3$

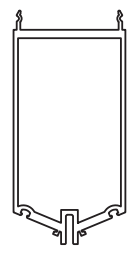

PLCW-607 with 2.2 x 3.625 x 10g  
 steel reinforcing

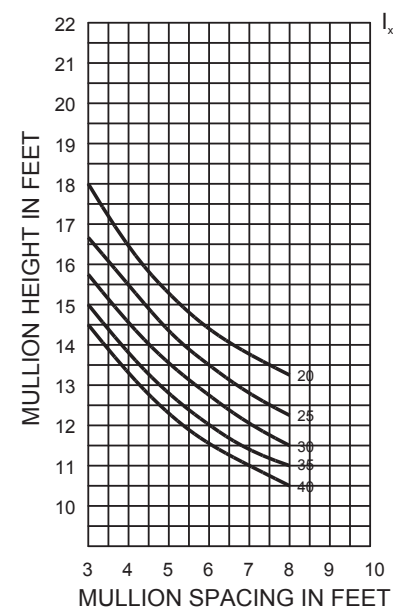

$I_{xx} = 12.166 \text{ IN}^4$

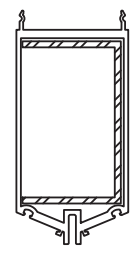

**PLCW-700 SERIES**  
**2 1/2" x 7"**  
**WIND LOAD**

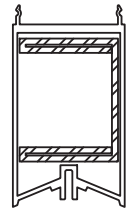
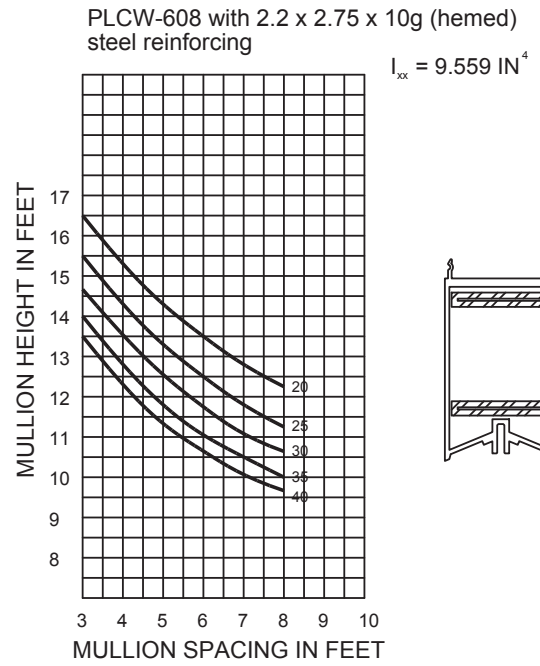
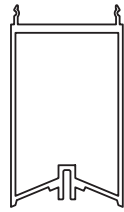
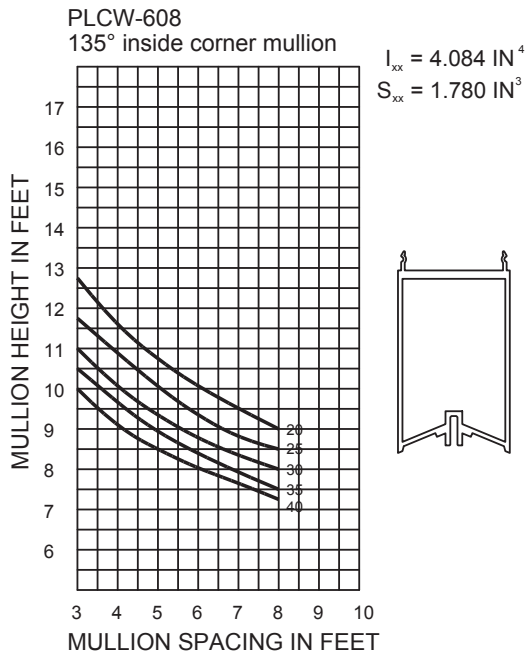

CURVE REPRESENTATION  
 A = 20 P.S.F.  
 B = 25 P.S.F.  
 C = 30 P.S.F.  
 D = 35 P.S.F.  
 E = 40 P.S.F.

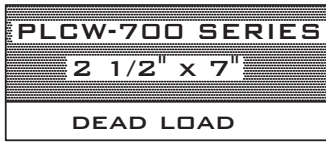

## dead load design

horizontal mullion deflection is limited to  $L/360$  or  $1/8''$  (whichever is less)  
curves represent limitations based on 2 point loads, equal in magnitude  
both located at  $1/8$  or  $1/4$  point of the horizontal mullions length

allowable stress for 6063-T6 aluminum alloy = 15000 p.s.i.  
allowable stress for A-36 steel = 21600 p.s.i.

maximum deflection was based on the following equation:

$$\Delta = \frac{Pa}{24EI} (3L^2 - 4a^2)$$

maximum bending moment was based on the following equation:

$$M = Pa$$

assumptions:

$P = 1/2$  glass weight

$a = 1/4$  or  $1/8$  point of span (in inches)

$E = 10 \times 10^6$  p.s.i.

$I =$  moment of inertia of the mullion

$L =$  length of horizontal mullion

**PLCW-700 SERIES**  
**2 1/2" x 7"**  
**DEAD LOAD**

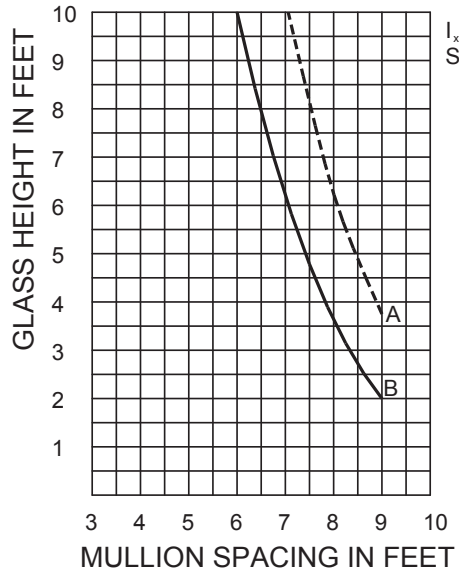

$I_{xx} = 1.716 \text{ IN}^4$   
 $S_{xx} = 1.373 \text{ IN}^3$

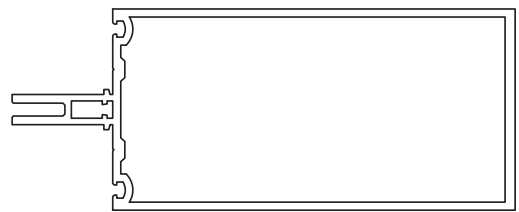

PLCW-701

**CURVE REPRESENTATION**  
**A ( - - - - - ) = 1/8 PTS.**  
**B ( ——— ) = 1/4 PTS.**

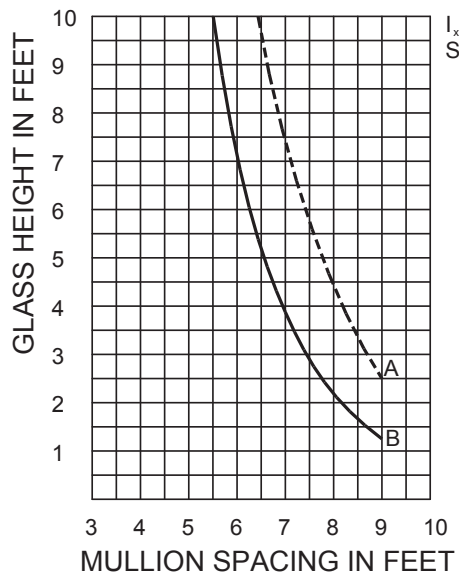

$I_{xx} = 1.103 \text{ IN}^4$   
 $S_{xx} = 0.735 \text{ IN}^3$

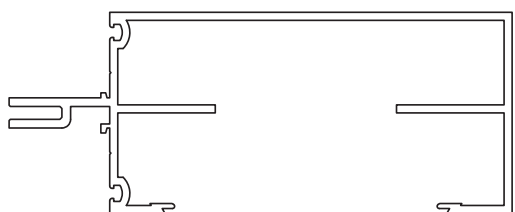

PLCW-702

# ALUMINUM ENTRANCE DOORS SECTION

# ALUMINUM ENTRANCE DOORS SECTION



## ALUMINUM DOORS

### **PART 1 GENERAL**

#### 1.1 SECTION INCLUDES

- A. Aluminum doors.

#### 1.2 REFERENCES

- A. ASTM International (ASTM):
  1. ASTM B 221 - Standard Specification for Aluminum and Aluminum-Alloy Extruded Bars, Rods, Wire, Profiles, and Tubes.
  2. ASTM E 283 - Test Method for Determining the Rate of Air Leakage Through Exterior Windows, Curtain Walls, and Doors under Specified Pressure Differences across the Specimen.
  3. ASTM E 330 - Standard Test Method for Structural Performance of Exterior Windows, Doors, Skylights and Curtain Walls by Uniform Static Air Pressure Difference.
  4. ASTM E 331 - Test Method for Water Penetration of Exterior Windows, Curtain Walls, and Doors by Uniform Static Air Pressure Difference.

#### 1.3 SUBMITTALS

- A. Submit under provisions of Section 01 30 00 - Administrative Requirements.
- B. Product Data: Manufacturer's data sheets on each product to be used, including:
  1. Preparation instructions and recommendations.
  2. Storage and handling requirements and recommendations.
  3. Installation methods.
- C. Shop Drawings: Configuration and details for installation, maintenance and operation.
- D. Selection Samples: For each finish product specified, two complete sets of color chips representing manufacturer's full range of available colors and patterns.
- E. Verification Samples: For each finish product specified, two samples, minimum size 6 inches (150 mm) square representing actual product, color, and patterns.

#### 1.4 QUALITY ASSURANCE

- A. Manufacturer Qualifications: Minimum 5 year experience manufacturing similar products.
- B. Installer Qualifications: Minimum 2 year experience installing similar products.
- C. Mock-Up: Provide a mock-up for evaluation of surface preparation techniques and application workmanship.
  1. Finish areas designated by Architect.
  2. Do not proceed with remaining work until workmanship is approved by Architect.
  3. Refinish mock-up area as required to produce acceptable work.

#### 1.5 PRE-INSTALLATION MEETINGS

### **ALUM. DOORS - 1**

- A. Convene minimum two weeks prior to starting work of this section.

#### 1.6 DELIVERY, STORAGE, AND HANDLING

- A. Deliver and store products in manufacturer's unopened packaging bearing the brand name and manufacturer's identification until ready for installation.
- B. Handling: Handle materials to avoid damage.

#### 1.7 PROJECT CONDITIONS

- A. Maintain environmental conditions (temperature, humidity, and ventilation) within limits recommended by manufacturer for optimum results. Do not install products under environmental conditions outside manufacturer's recommended limits.

#### 1.8 SEQUENCING

- A. Ensure that products of this section are supplied to affected trades in time to prevent interruption of construction progress.

### **PART 2 PRODUCTS**

#### 2.1 MANUFACTURERS

- A. Acceptable Manufacturer: PRL Glass Systems, Inc., which is located at: 13644 Nelson Ave.; City of Industry, CA 91746; Toll Free Tel: 800-433-7044; Fax: 626-968-9256; Email: request; Web:[prlglass.com](http://prlglass.com)
- B. Substitutions: Not permitted.
- C. Requests for substitutions will be considered in accordance with provisions of Section 01 60 00 - Product Requirements.

#### 2.2 DOORS

- A. Narrow Stile:
  - 1. 2 inches (51 mm) stile and rail.
  - 2. Strong reinforced corner construction permits use in heavy traffic areas of commercial applications.
  - 3. Narrow stile Center pivot single acting.
  - 4. Offset pivot single acting.
  - 5. Butt hinge single acting.
- B. Medium Stile:
  - 1. 3-1/2 inches stile with 3-1/4 inches rail.
  - 2. Medium stile Center pivot double acting
  - 3. Offset pivot single acting
  - 4. Butt hinge single acting.
  - 5. A top performance door with a medium stile that accommodates standard and custom hardware and panic devices for commercial and institutional applications.
  - 6. Strong reinforced corner construction increases size limitation to a 4'-0" door width 9'0" maximum door height.
- C. Wide Stile:
  - 1. 5 inches (127 mm) stile with 5-1/8 inches (130 mm) rail.
  - 2. Wide stile Center pivot double acting
  - 3. Offset pivot single acting
  - 4. Butt hinge single acting.

### **ALUM. DOORS - 2**

5. A monumental type door with strength and stability for heavy use. The wide stiles will accommodate most all standard and unusual hardware designs and operation requirements. Size limitations are 4'-0" door width and 9'0" maximum door height.
- D. Custom Door:
1. Offer style and performance with unlimited adaptability to specific design requirements with combinations of stiles, top/bottom rails and intermediate vertical/horizontal muntins, will receive most standard pivot/hinges, lock and security hardware. Strong reinforced corner construction permits its use on a wide variety of applications. Some limitations apply please consult PRL Aluminum for details.
- E. Accessories:
1. ADA Bottom Rail: 10-1/2 inches (267 mm) high.
  2. Threshold: 4 inches (102 mm) extruded aluminum
    - a. Finish: Mill.
    - b. Finish: Clear anodized.
    - c. Finish: Bronze.
  3. Threshold: 5 inches (127 mm) extruded aluminum
    - a. Finish: Mill.
    - b. Finish: Clear anodized.
    - c. Finish: Bronze.
  4. Threshold: 5 inches (127 mm) extruded aluminum with bulb seal.
    - a. Finish: Mill.
    - b. Finish: Clear anodized.
    - c. Finish: Bronze.
  5. Threshold: 7 inches (178 mm) extruded aluminum.
    - a. Finish: Mill.
    - b. Finish: Clear anodized.
    - c. Finish: Bronze.
- F. Hardware:
1. Refer to Section 08 71 53 - Security Door Hardware.

## **PART 3 EXECUTION**

### 3.1 EXAMINATION

- A. Do not begin installation until substrates have been properly prepared.
- B. If substrate preparation is the responsibility of another installer, notify Architect of unsatisfactory preparation before proceeding.

### 3.2 PREPARATION

- A. Clean surfaces thoroughly prior to installation.
- B. Prepare surfaces using the methods recommended by the manufacturer for achieving the best result for the substrate under the project conditions.

### 3.3 INSTALLATION

- A. Install in accordance with manufacturer's instructions.

### 3.4 FIELD QUALITY CONTROL

- A. All joints between metal and masonry shall be fully caulked and field tested to resist water leakage with provisions taken to drain infiltrated water.

### 3.5 PROTECTION

- A. Protect installed products until completion of project.
- B. Touch-up, repair or replace damaged products before Substantial Completion.

END OF SECTION

All Entrance Doors are available in single acting offset pivot, butt hinge or center pivot operation. High bottom rails may be adapted to all sizes and to meet local codes. All doors are produced to specific size requirements in widths and heights within limits of each specific door.

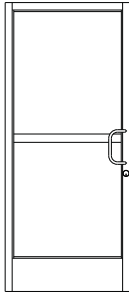

**Narrow stile**

Narrow stile Center pivot single acting, Offset pivot single acting, Butt hinge single acting. An industry standard in style and performance. Narrow stiles and rails provide narrow sight lines yet receives most standard hardware designs. Strong reinforced corner construction permits use in heavy traffic areas of commercial applications.

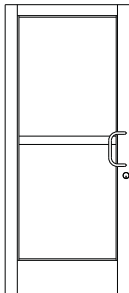

**Medium stile**

Medium stile Center pivot double acting, Offset pivot single acting, Butt hinge single acting. A top performance door with a medium stile that accommodates standard and custom hardware and panic devices for commercial and institutional applications. Strong reinforced corner construction increases size limitation to a 4'-0" door width 9'0" maximum door height.

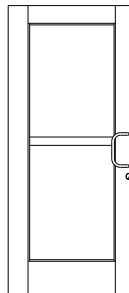

**Wide stile**

Wide stile Center pivot double acting, Offset pivot single acting, Butt hinge single acting. A monumental type door with strength and stability for heavy use. The wide stiles will accommodate most all standard and unusual hardware designs and operation requirements. Size limitations are 4'-0" door width and 9'0" maximum door height.

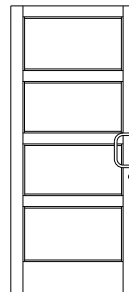

**Custom Doors**

Offer style and performance with unlimited adaptability to specific design requirements with combinations of stiles, top/bottom rails and intermediate vertical/horizontal muntins, will receive most standard pivot/hinges, lock and security hardware. Strong reinforced corner construction permits its use on a wide variety of applications. Some limitations apply please consult PRL Aluminum for details.

## CENTER HUNG

Standard doors hardware includes std lock/cylinder on single doors and pairs active leaf, header/threshold bolt for pairs inactive leaf with push bars BTB.

All doors are prepared to receive side load arm for concealed closers (pivots are not included).

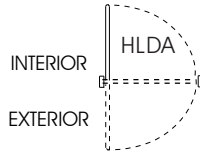
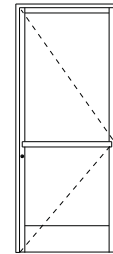
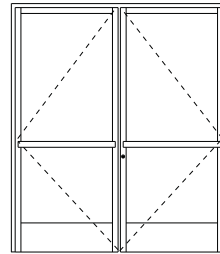
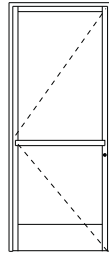

HINGED LEFT  
DOUBLE ACTING

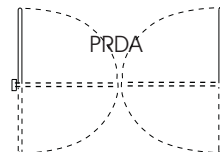

PAIR OF DOUBLE ACTING



HINGED RIGHT  
DOUBLE ACTING

## OFFSET HUNG

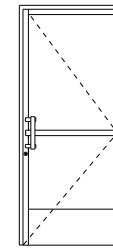
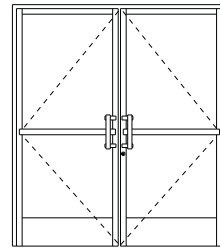
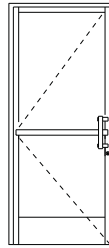

HINGED LEFT  
SWING OUT

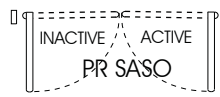

PAIR OF SINGLE ACTING  
SWING IN



HINGED RIGHT  
SWING OUT

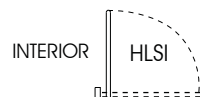
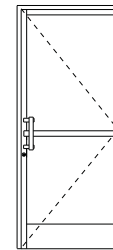
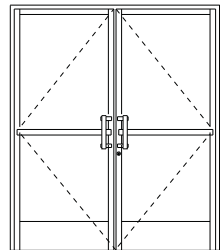
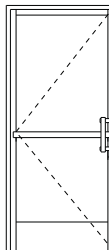

HINGED LEFT  
SWING IN

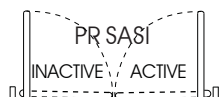

PAIR OF SINGLE ACTING  
SWING OUT



HINGED RIGHT  
SWING IN

**NARROW STYLE**  
 2" VERTICAL STILE

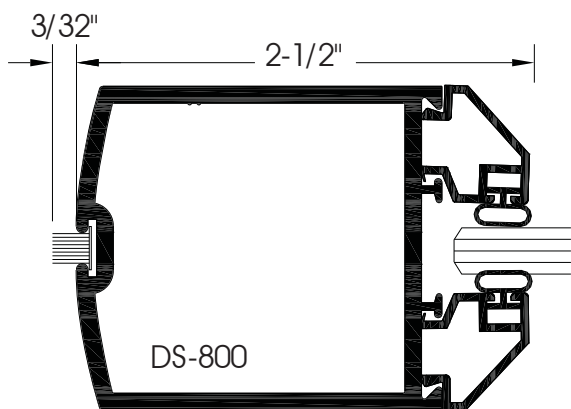

**CENTER HUNG DOOR**  
 1/4" BEVEL GLASS STOP

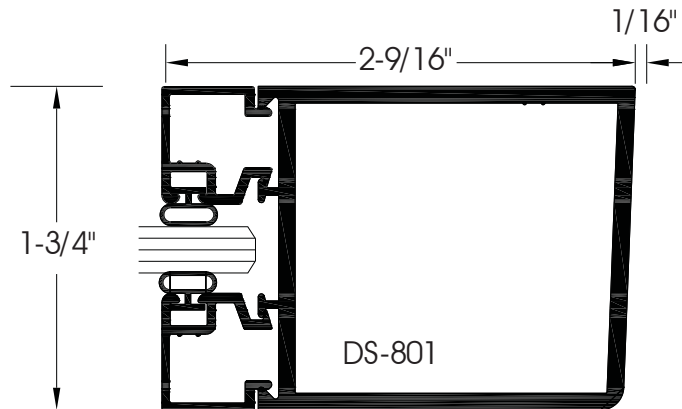

**DRGS-14**  
**OFFSET HUNG DOOR**  
 1/4" SQUARE GLASS STOP

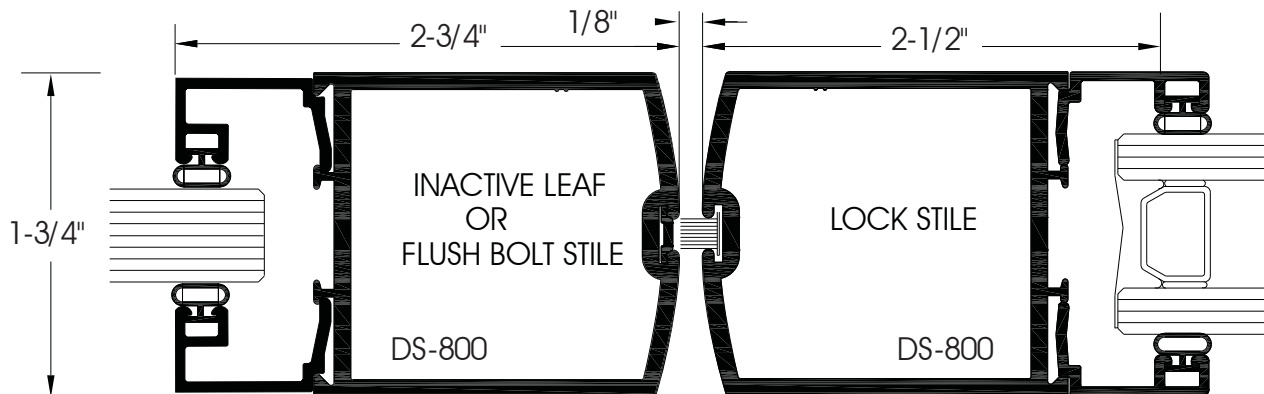

**DRGS-12**  
**CENTER HUNG DOORS**  
 1/2" GLASS STOP

**MEETINGSTILES**

**DRGS-1**  
**CENTER HUNG DOORS**  
 1" GLASS STOP



**MATERIAL:** 6063-T5 aluminum alloy.

**FINISH:** Standard finishes are mill, clear and bronze anodized. All others are special order.

**NOTES:** Storefronts are available in quick set or screw race, please consult PRL aluminum for details

**ALUM. DOORS - 7**

ENTRANCE DOORS  
 1/4"-1" GLASS STOP  
 FULL SCALE



NARROW STYLE  
 2" RAIL

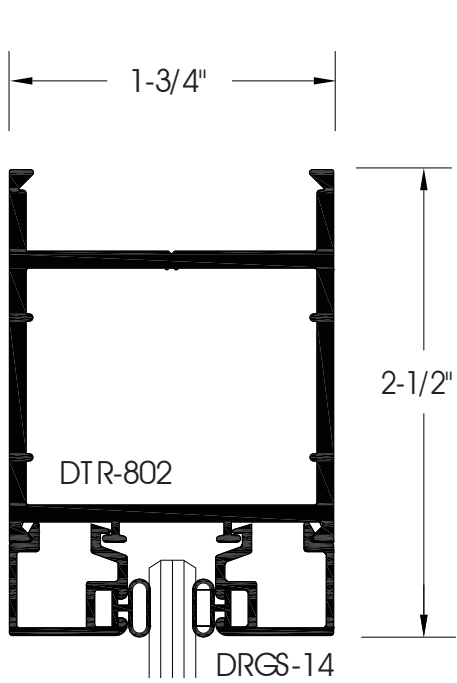

TOP/BOTTOM  
 DOOR RAIL  
 1/4" GLASS STOP

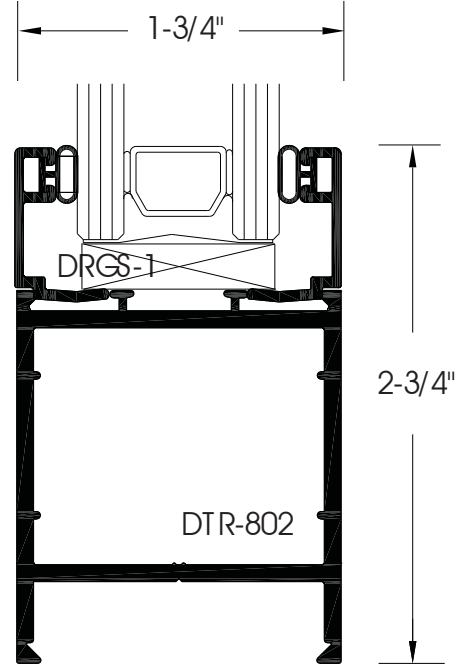

TOP/BOTTOM  
 DOOR RAIL  
 1" GLASS STOP

**FINISH:** Standard finishes are mill, clear and bronze anodized. All others are special order.  
**NOTES:** Storefronts are available in quick set or screw race, please consult PRL aluminum for details

**ALUM. DOORS - 8**  
 14760 Don Julian Rd.  
 Industry, CA 91746

ph: (877) 775-2586  
 fx: (877) 274-8800

[www.prlaluminum.com](http://www.prlaluminum.com)  
[sales@prlaluminum.com](mailto:sales@prlaluminum.com)



**ENTRANCE DOORS**  
**1/2"-1" GLASS STOP**  
**FULL SCALE**



**MEDIUM STYLE**  
 3 1/2" VERTICAL STILE

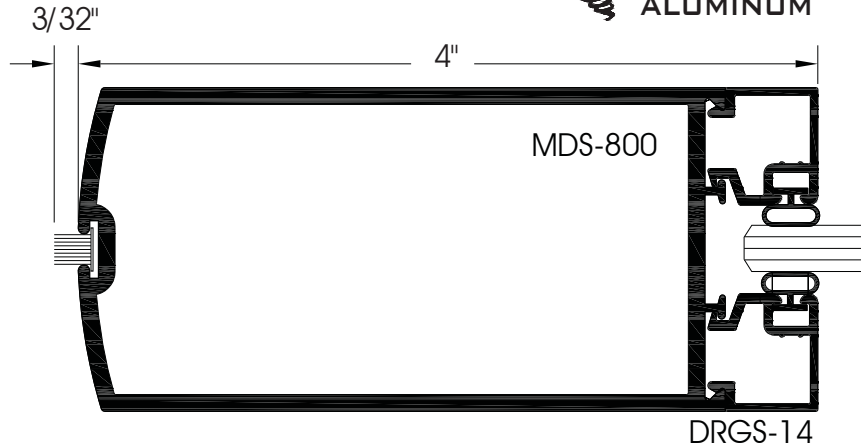

**CENTER HUNG DOOR STILE**  
 1/4" GLASS STOP

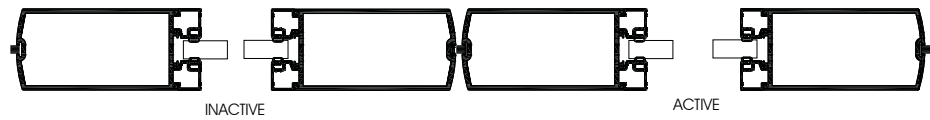

**INACTIVE LEAF DOOR STILE**  
 1" GLASS STOP

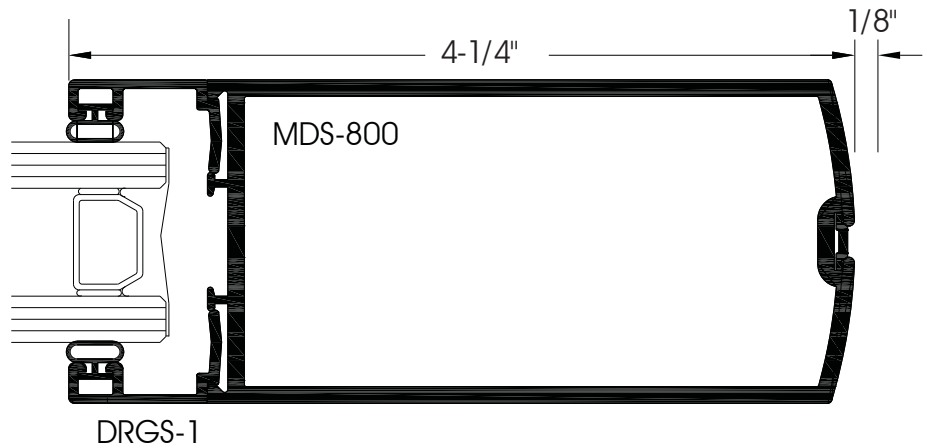

**OFFSET HUNG DOOR STILE**  
 1/4" GLASS STOP

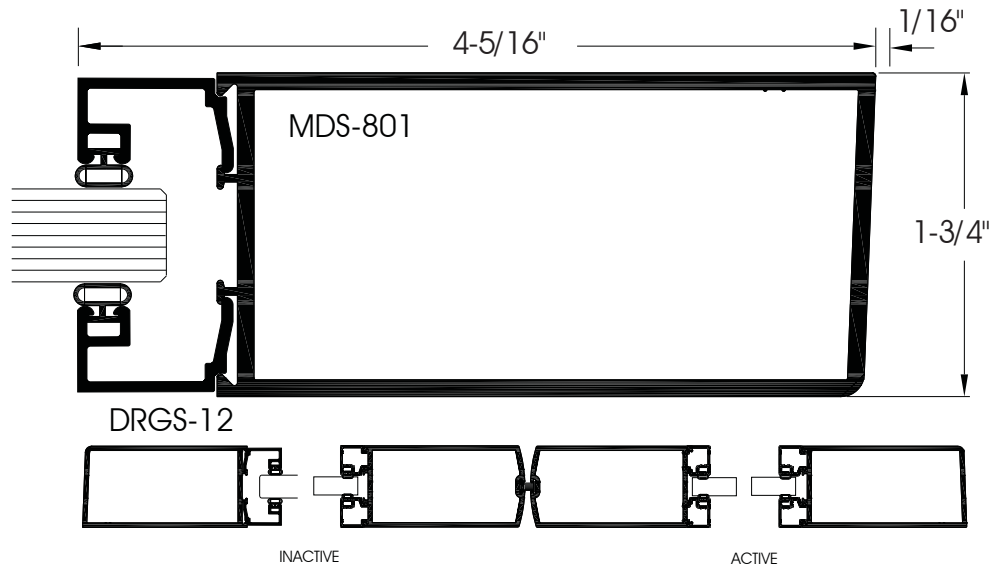

**MATERIAL:** 6063-T5 aluminum alloy.

**FINISH:** Standard finishes are mill, clear and bronze anodized. All others are special order.

**NOTES:** Storefronts are available in quick set or screw race, please consult PRL aluminum for details

**ALUM. DOORS - 9**

14760 Don Julian Rd.  
 Industry, CA 91746

ph: (877) 775-2586  
 fx: (877) 274-8800

www.prlaluminum.com  
 sales@prlaluminum.com

ENTRANCE DOORS  
 1/4"-1" GLASS STOP  
 FULL SCALE



MEDIUM STYLE s  
 3 1/4" RAIL

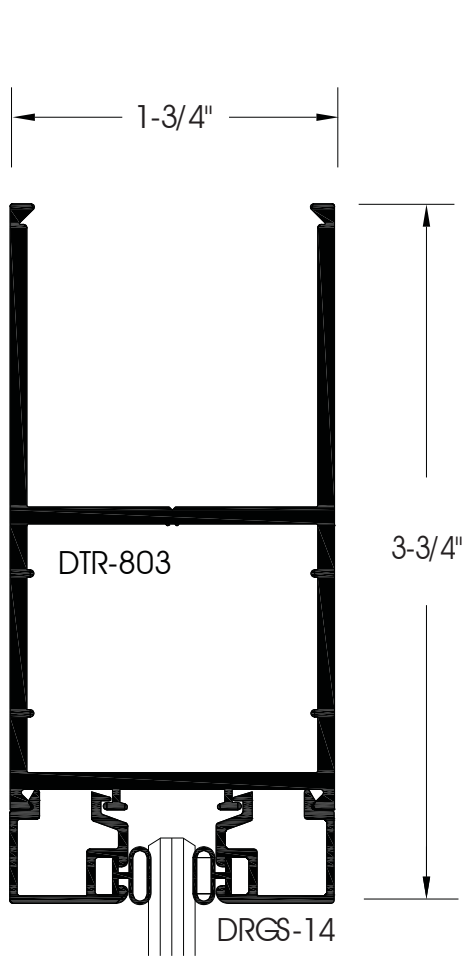

TOP/BOTTOM  
 DOOR RAIL  
 1/4" GLASS STOP

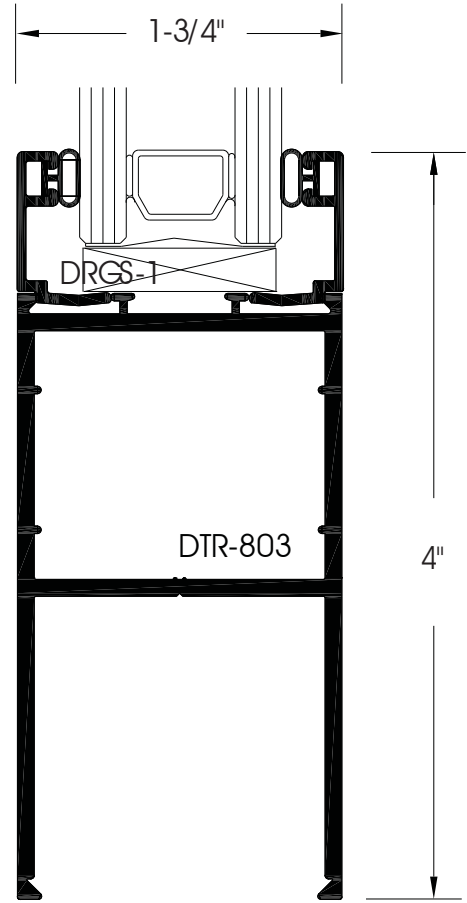

TOP/BOTTOM  
 DOOR RAIL  
 1" GLASS STOP

**MATERIAL:** 6063-T5 aluminum alloy.

**FINISH:** Standard finishes are mill, clear and bronze anodized. All others are special order.

**NOTES:** Storefronts are available in quick set or screw race, please consult PRL aluminum for details

**ALUM. DOORS - 10**

14760 Don Julian Rd.  
 Industry, CA 91746

ph: (877) 775-2586  
 fx: (877) 274-8800

www.prlaluminum.com  
 sales@prlaluminum.com

**ENTRANCE DOORS**  
**1/2"-1" GLASS STOP**  
**FULL SCALE**

**WIDE STYLE**  
 5" VERTICAL STILE

**CENTER HUNG**  
**DOOR STILE**  
 1/4" GLASS STOP

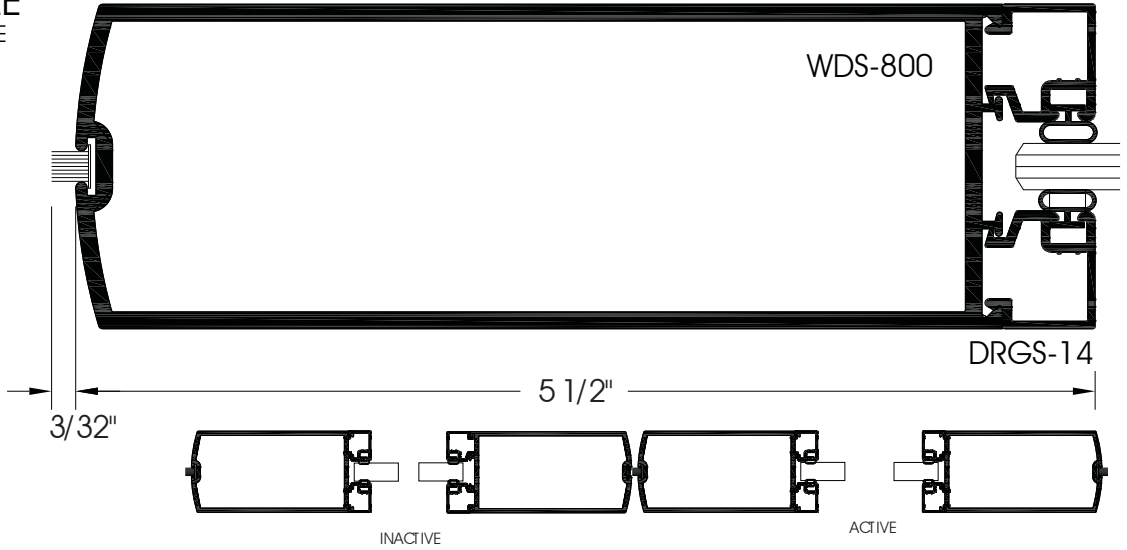

**INACTIVE LEAF**  
**DOOR STILE**  
 1" GLASS STOP

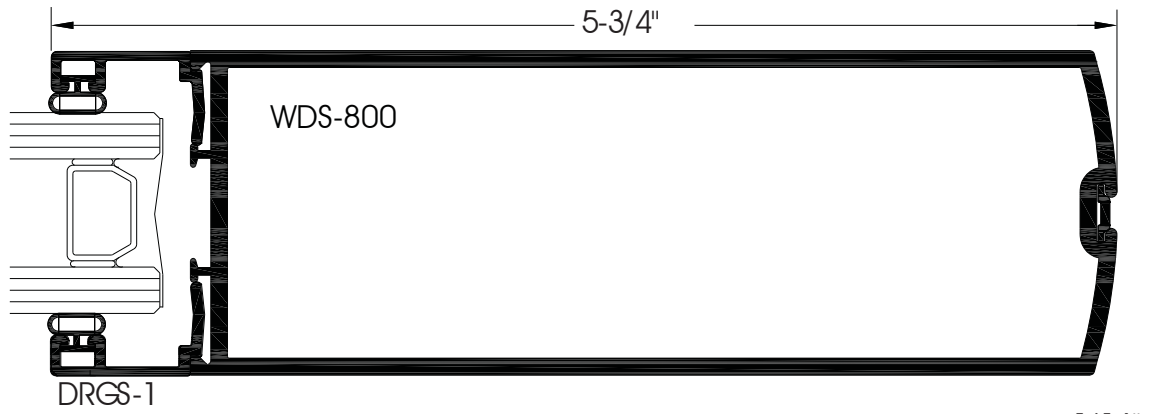

**OFFSET HUNG**  
**DOOR STILE**  
 1/2" GLASS STOP

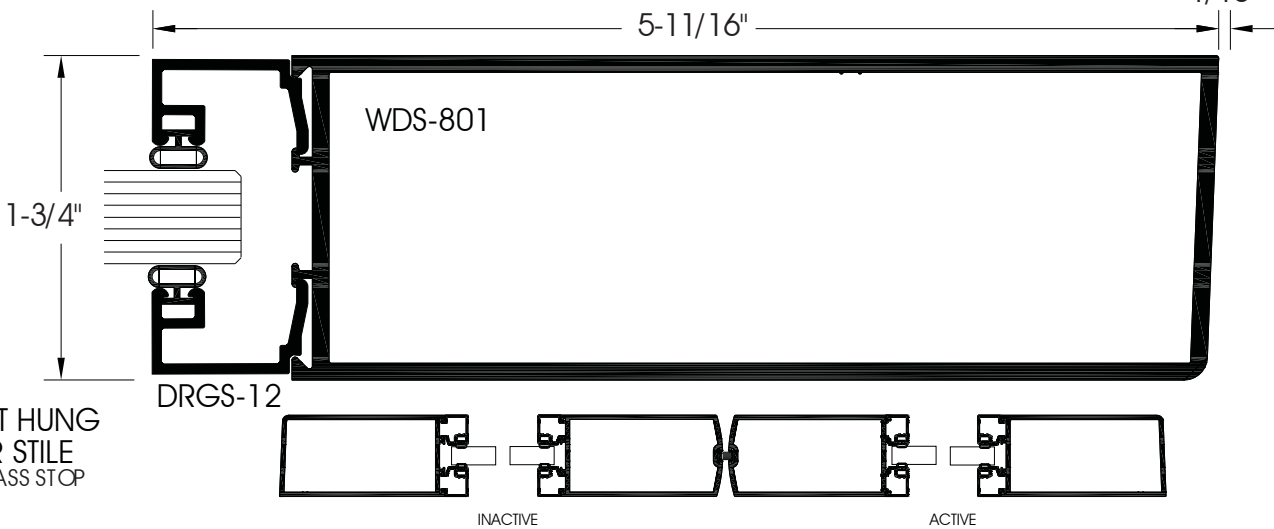

**MATERIAL:** 6063-T5 aluminum alloy.  
**FINISH:** Standard finishes are mill, clear and bronze anodized. All others are special order.  
**NOTES:** Storefronts are available in quick set or screw race, please consult PRL aluminum for details

**ALUM. DOORS - 11**

**ENTRANCE DOORS**  
**1/4"-1" GLASS STOP**  
**FULL SCALE**



**WIDE STYLE**

5 1/8" RAIL

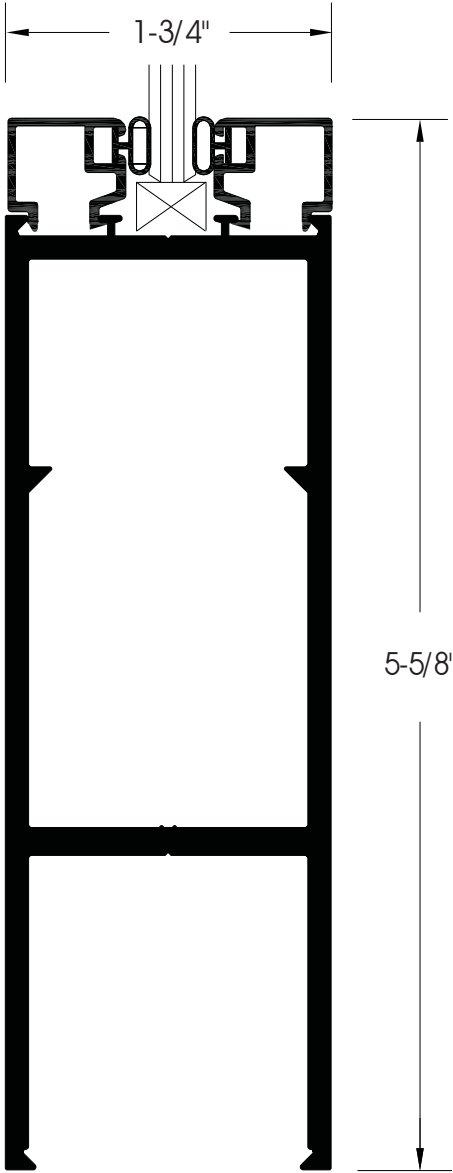

TOP/BOTTOM  
 DOOR RAIL  
 1/4" GLASS STOP

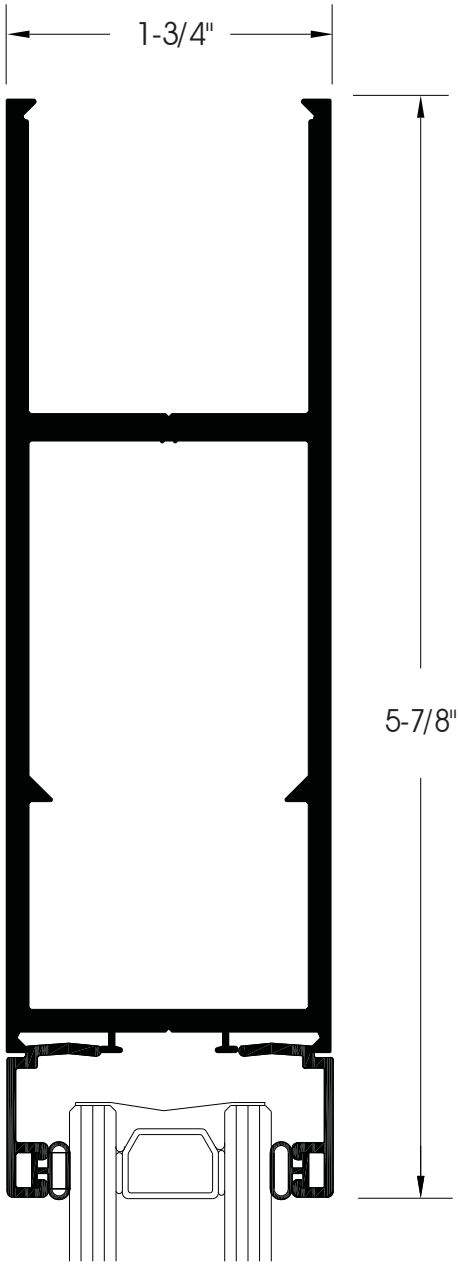

TOP/BOTTOM  
 DOOR RAIL  
 1" GLASS STOP

**MATERIAL:** 6063-T5 aluminum alloy.  
**FINISH:** Standard finishes are mill, clear and bronze anodized. All others are special order.  
**NOTES:** Storefronts are available in quick set or screw race, please consult PRL aluminum for details

**ALUM. DOORS - 12**

ph: (877) 775-2586  
 fx: (877) 274-8800

14760 Don Julian Rd.  
 Industry, CA 91746

www.prlaluminum.com  
 sales@prlaluminum.com

4" THRESHOLD

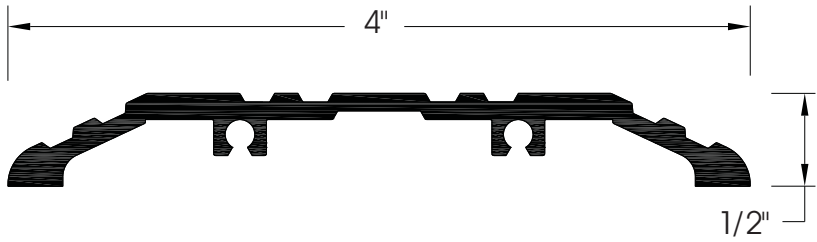

5" THRESHOLD

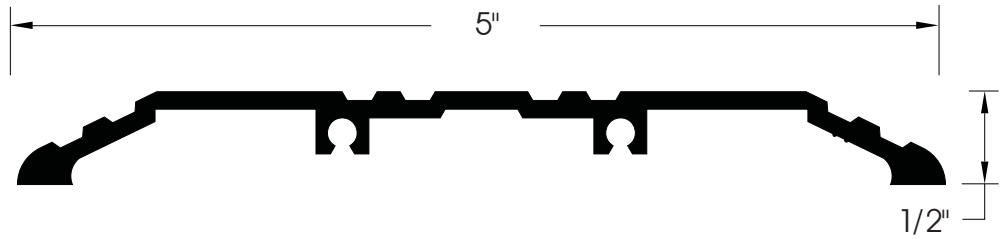

5" THRESHOLD

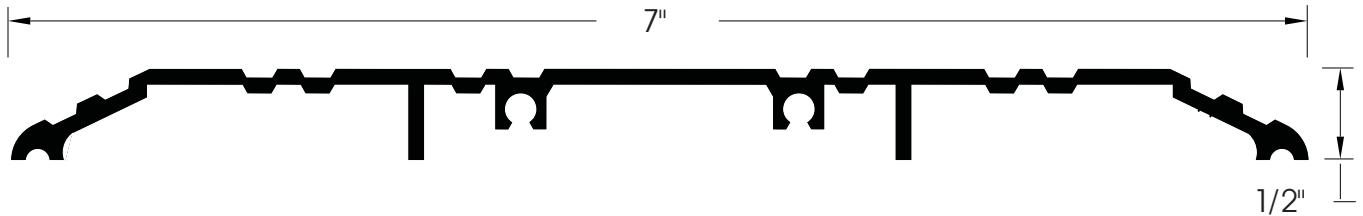
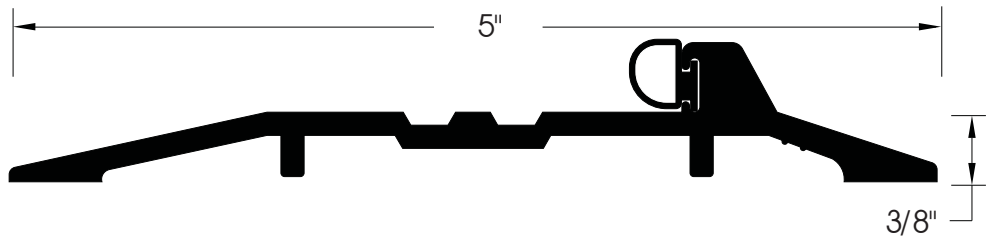

7" THRESHOLD

**MATERIAL:** 6063-T5 aluminum alloy.

**FINISH:** Standard finishes are mill, clear and bronze anodized. All others are special order.

**NOTES:** Storefronts are available in quick set or screw race, please consult PRL aluminum for details

**ALUM. DOORS - 13**

**ENTRANCE DOORS**  
**1/4"-1" GLASS STOP**  
**FULL SCALE**



10" BOTTOM RAIL



TYPICAL APPLICATION

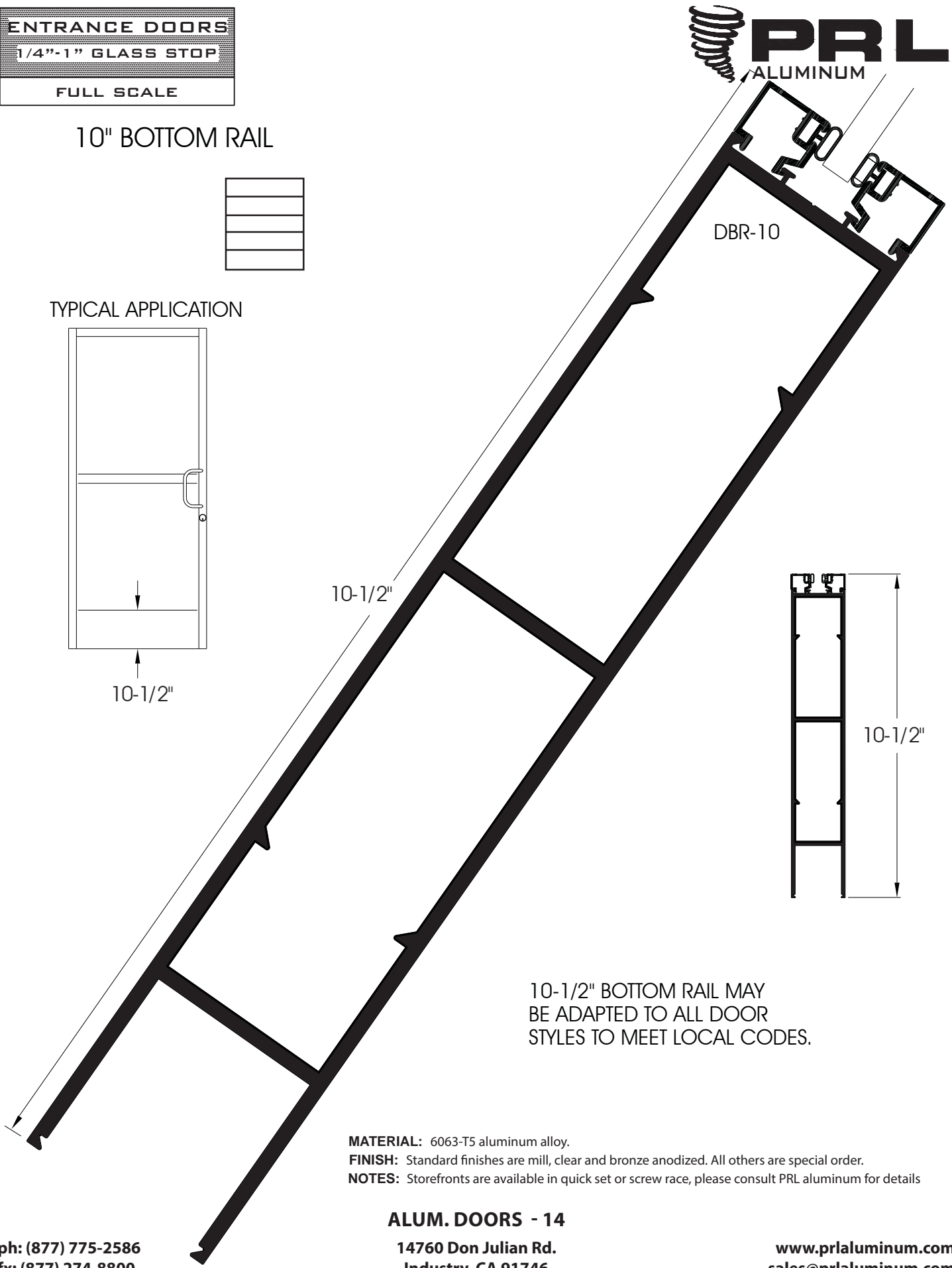
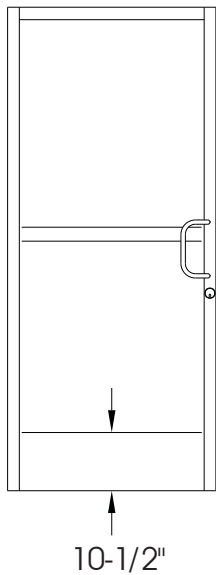

10-1/2" BOTTOM RAIL MAY BE ADAPTED TO ALL DOOR STYLES TO MEET LOCAL CODES.

**MATERIAL:** 6063-T5 aluminum alloy.

**FINISH:** Standard finishes are mill, clear and bronze anodized. All others are special order.

**NOTES:** Storefronts are available in quick set or screw race, please consult PRL aluminum for details

**ALUM. DOORS - 14**

14760 Don Julian Rd.  
 Industry, CA 91746

ph: (877) 775-2586  
 fx: (877) 274-8800

[www.prlaluminum.com](http://www.prlaluminum.com)  
[sales@prlaluminum.com](mailto:sales@prlaluminum.com)

# HORIZONTAL MUNTIN

3 1/4" MUNTIN

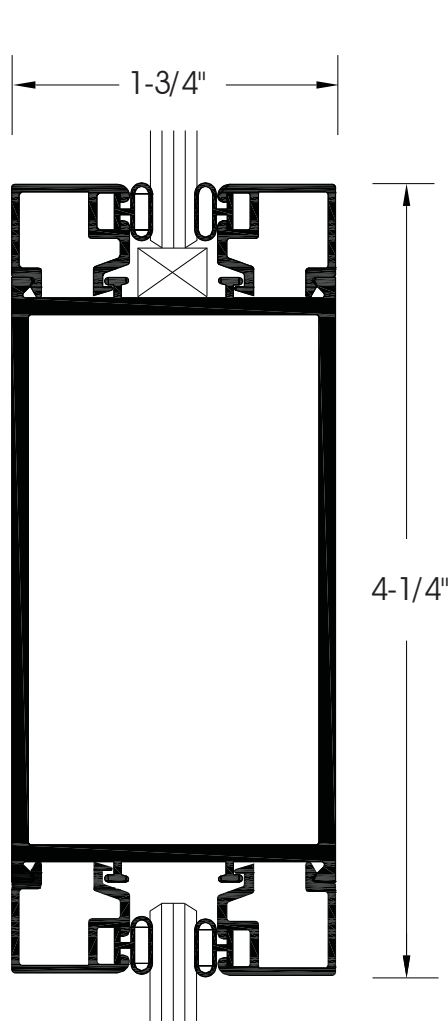

HORIZONTAL  
 DOOR MUNTIN  
 1/4" GLASS STOP

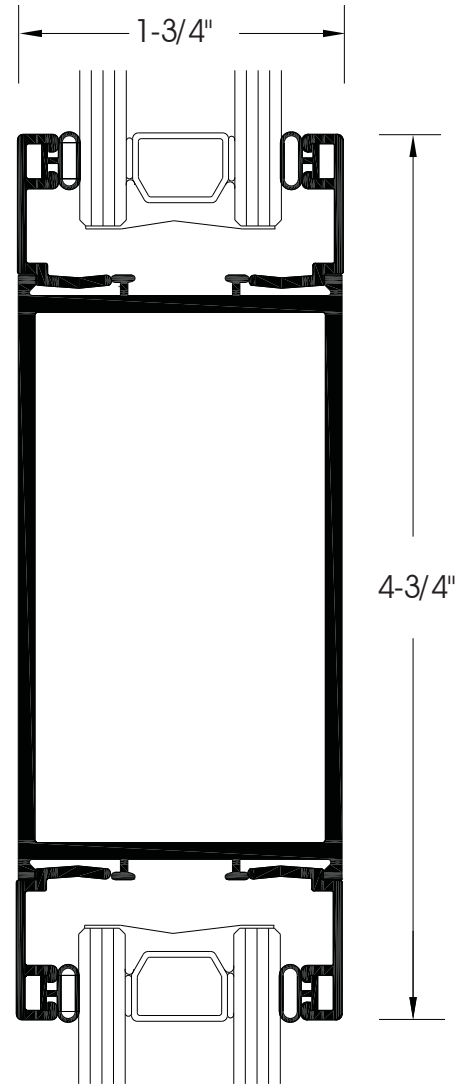

HORIZONTAL  
 DOOR MUNTIN  
 1" GLASS STOP

**MATERIAL:** 6063-T5 aluminum alloy.

**FINISH:** Standard finishes are mill, clear and bronze anodized. All others are special order.

**NOTES:** Storefronts are available in quick set or screw race, please consult PRL aluminum for details

## ALUM. DOORS - 15

14760 Don Julian Rd.  
 Industry, CA 91746

ph: (877) 775-2586  
 fx: (877) 274-8800

www.prlaluminum.com  
 sales@prlaluminum.com

HORIZONTAL MUNTIN  
 2" MUNTIN

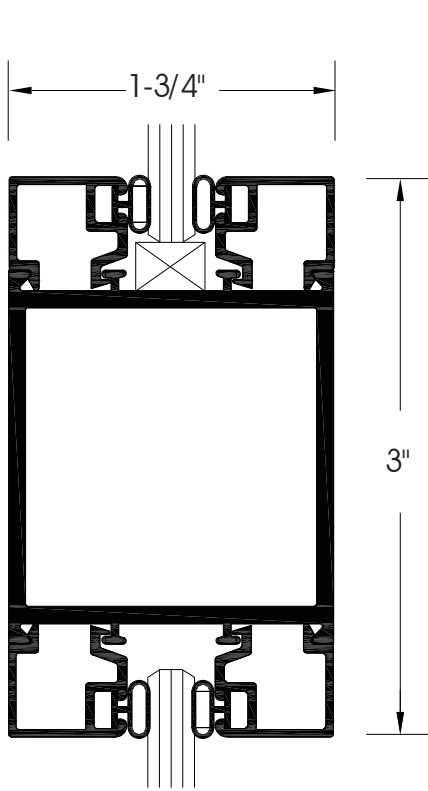

HORIZONTAL  
 DOOR MUNTIN  
 1/4" GLASS STOP

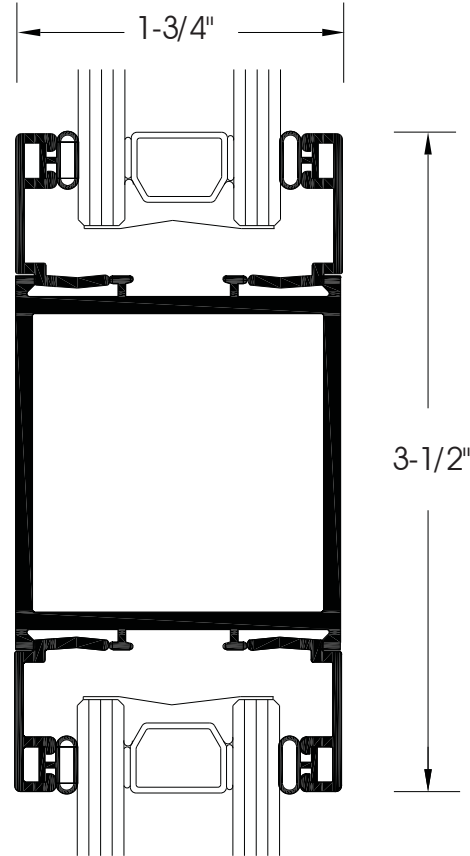

HORIZONTAL  
 DOOR MUNTIN  
 1" GLASS STOP

**MATERIAL:** 6063-T5 aluminum alloy.

**FINISH:** Standard finishes are mill, clear and bronze anodized. All others are special order.

**NOTES:** Storefronts are available in quick set or screw race, please consult PRL aluminum for details

**ALUM. DOORS - 16**

ph: (877) 775-2586  
 fx: (877) 274-8800

14760 Don Julian Rd.  
 Industry, CA 91746

www.prlaluminum.com  
 sales@prlaluminum.com



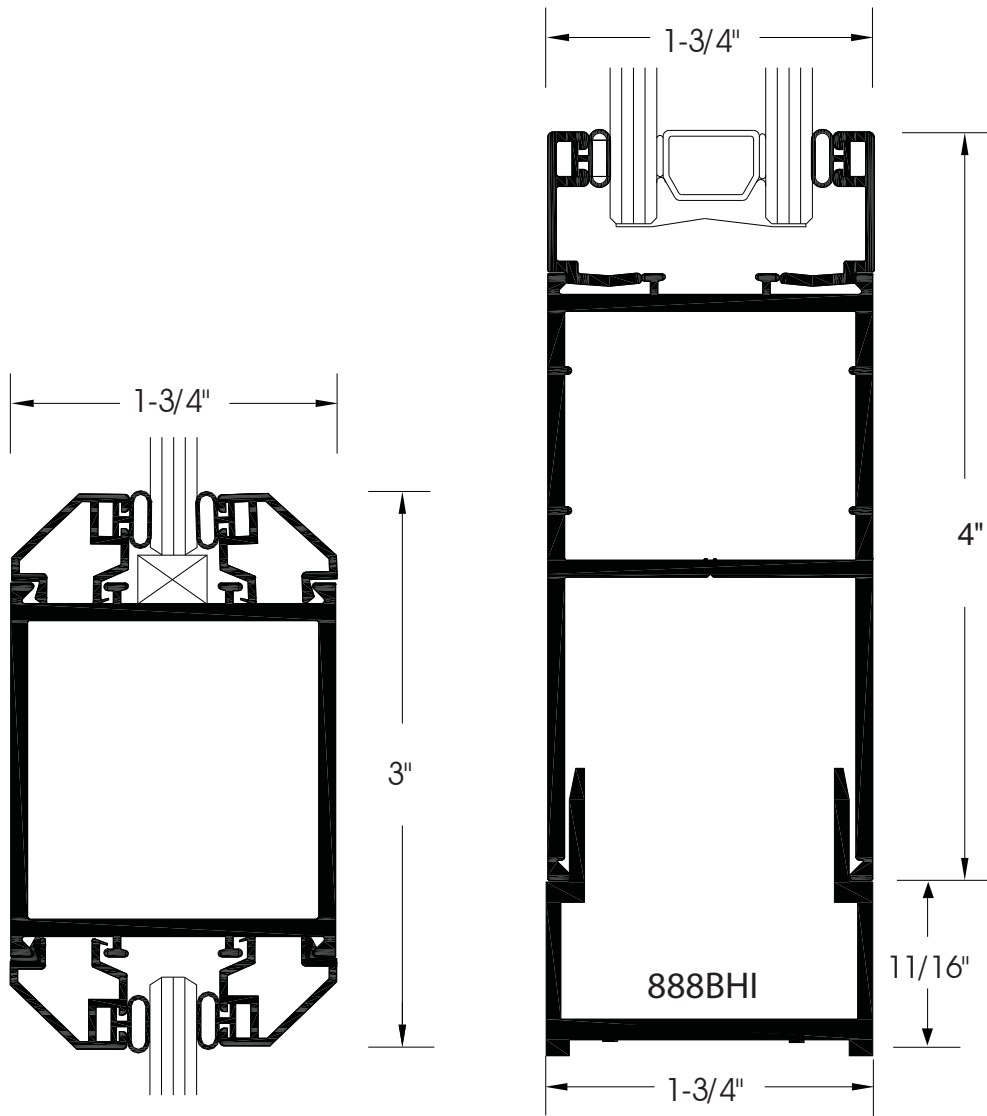

HORIZONTAL  
 DOOR MUNTIN  
 + 1/4" BEVEL GLASS STOP

DOOR RAIL  
 + BULK HEAD INSERT

**MATERIAL:** 6063-T5 aluminum alloy.

**FINISH:** Standard finishes are mill, clear and bronze anodized. All others are special order.

**NOTES:** Storefronts are available in quick set or screw race, please consult PRL aluminum for details

**ALUM. DOORS - 17**

ph: (877) 775-2586  
 fx: (877) 274-8800

14760 Don Julian Rd.  
 Industry, CA 91746

www.prlaluminum.com  
 sales@prlaluminum.com



# SLIDING DOORS SECTION

# SLIDING DOORS SECTION



## ALUMINUM SLIDING GLASS DOORS

### **PART 1 GENERAL**

#### 1.1 SECTION INCLUDES

- A. Aluminum sliding glass doors - top hung.
- B. Aluminum sliding glass doors - bottom roller supported.

#### 1.2 REFERENCES

- A. American Architectural Manufacturers Association (AAMA):
  - 1. AAMA/NWWDA 101/I.S. 2-97 - Voluntary Specification, Performance Requirements and Test Procedures for Air Leakage Resistance, Water Penetration Resistance, Structural Loading, Forced Entry Resistance.
- B. ASTM International (ASTM):
  - 1. ASTM E 283 - Test Method for Determining the Rate of Air Leakage Through Exterior Windows, Curtain Walls, and Doors under Specified Pressure Differences across the Specimen.
  - 2. ASTM E 331 - Test Method for Water Penetration of Exterior Windows, Curtain Walls, and Doors by Uniform Static Air Pressure Difference.
  - 3. ASTM E 1886 - Standard Test Method for Performance of Exterior Windows, Curtain Walls, Doors, and Impact Protective Systems Impacted by Missile(s) and Exposed to Cyclic Pressure Differentials.
  - 4. ASTM E 1996 - Standard Specification for Performance of Exterior Windows, Curtain Walls, Doors and Impact Protective Systems Impacted by Windborne Debris in Hurricanes.

#### 1.3 SUBMITTALS

- A. Submit under provisions of applicable Requirements.
- B. Product Data: Manufacturer's data sheets on each product to be used, including:
  - 1. Provide AAMA test report in its entirety complete with drawing pages that show sill configuration tested.
  - 2. Storage and handling requirements and recommendations.
  - 3. Provide installation instructions, preparation instructions and recommendations.
- C. Shop Drawings:
  - 1. Provide drawings showing each configuration.
- D. Selection Samples: For each finish product specified, two complete sets of color chips representing manufacturer's full range of available colors and patterns.
  - 1. Provide color samples of available finishes.
    - a. Provide hardware samples.
- E. Verification Samples: For each finish product specified, two samples, minimum size 6 inches (150 mm) square representing actual product, color, and patterns.
  - 1. Provide color samples of specified finish.
    - a. Provide hardware samples.

### **ALUM. SLIDERS - 1**

#### 1.4 QUALITY ASSURANCE

- A. Manufacturer Qualifications: Minimum 5 year experience manufacturing similar products.
- B. Installer Qualifications: Minimum 2 year experience installing similar products.
- C. Mock-Up: Provide a mock-up for evaluation of surface preparation techniques and application workmanship.
  - 1. Finish areas designated by Architect.
  - 2. Do not proceed with remaining work until workmanship is approved by Architect.
  - 3. Refinish mock-up area as required to produce acceptable work.

#### 1.5 PRE-INSTALLATION MEETINGS

- A. Convene minimum two weeks prior to starting work of this section.

#### 1.6 DELIVERY, STORAGE, AND HANDLING

- A. Deliver and store products in manufacturer's unopened packaging bearing the brand name and manufacturer's identification until ready for installation.
- B. Handling: Handle materials to avoid damage.

#### 1.7 PROJECT CONDITIONS

- A. Maintain environmental conditions (temperature, humidity, and ventilation) within limits recommended by manufacturer for optimum results. Do not install products under environmental conditions outside manufacturer's recommended limits.

#### 1.8 SEQUENCING

- A. Ensure that products of this section are supplied to affected trades in time to prevent interruption of construction progress.

### **PART 2 PRODUCTS**

#### 2.1 MANUFACTURERS

- A. Acceptable Manufacturer: PRL Glass Systems, Inc., which is located at: 13644 Nelson Ave.; City of Industry, CA 91746; Toll Free Tel: 800-433-7044; Fax: 626-968-9256; Email:[request info \(info@prlglass.com\)](mailto:requestinfo@prlglass.com); Web:[prlglass.com](http://prlglass.com)
- B. Substitutions: Not permitted.
- C. Requests for substitutions will be considered in accordance with provisions of Section 01 60 00 - Product Requirements.

#### 2.2 ALUMINUM SLIDING GLASS DOORS - TOP HUNG

- A. Product: Max Slider - Cabo Series as manufactured by PRL Glass Systems, Inc.
- B. Hardware:
  - 1. Locks shall be stainless steel.
  - 2. Pull handles shall be stainless steel, aluminum or brass/bronze.
  - 3. Trolley Wheels:
- C. Performance:
  - 1. Rating: Provide Sliding Aluminum doors for exterior use that have a minimum AAMA - 101 rating of R-PG15-SD when the sill height is less than 5/8 inch (16 mm). Gateway

### **ALUM. SLIDERS - 2**

- Size: 87 inches by 84 inches (2210 mm by 2134 mm).
2. Air Infiltration: Limit air leakage through fixed glazing and frames to 0.28 cfm/ft<sup>2</sup>/min (1.50 L/s/m<sup>2</sup>) when tested in accordance with ASTM E-283-04 at a cross pressure of 1.57 psf (75 Pa).
  3. Water Penetration under Static Pressure: System shall not evidence uncontrolled water penetration at a cross pressure of 2.92 psf (180 Pa) when tested in accordance with ASTM-E331-00.

### 2.3 ALUMINUM SLIDING GLASS DOORS - BOTTOM ROLLER SUPPORTED

- A. Product: Max Slider - Cancun Series as manufactured by PRL Glass Systems, Inc.
- B. Hardware:
  1. Locks shall be stainless steel.
  2. Pull handles shall be stainless steel, aluminum or brass/bronze.
  3. Sliding wheels shall be a minimum diameter of 3 inches (76 mm) and be 100% stainless steel. No exceptions.
- C. Performance:
  1. Rating: Provide Sliding Aluminum doors for exterior use that have a minimum AAMA - 101 rating of R-PG15-SD when the sill height is less than 5/8 inch (16 mm).
  2. Rating: Provide Sliding Aluminum doors for exterior use that have a minimum AAMA - 101 rating of CW-PG35-SD when the sill height is greater than 5/8 inch (16 mm).
  3. Air Infiltration: Limit air leakage through fixed glazing and frames to 0.30 cfm/ft<sup>2</sup>/min (1.50 L/s/m<sup>2</sup>) when tested in accordance with ASTM E-283-04 at a cross pressure of 1.57 psf (75 Pa).
  4. Water Penetration under Static Pressure: System shall not evidence uncontrolled water penetration at a cross pressure of 2.92 psf (180 Pa) when tested in accordance with ASTM-E331-00.
  5. Large Missile Impact: Design and fabrication shall meet the performance requirements in the referenced test procedures for a +1676/-2873 Pa (+35/-60 psf) design pressure with missile impacts corresponding to Missile Level D and Wind Zone 3 for a Basic Protection Rating. (Laminated I.G. 1-1/8 inches (29 mm) I.G. Marine glazed into a rubber glazing gasket.

### 2.4 MATERIALS

- A. Extrusions: Frames, assembly clips, trims and miscellaneous extrusions shall be extruded from 6063-T6 aluminum alloy.
- B. Glazing Gaskets: Marine type glazing gaskets shall meet the requirements of ASTM D-2287.

### 2.5 FABRICATION

- A. Comply with the applicable provisions of the AAMA windows and sliding glass doors manual for materials, fabrication and installation of doors and components.

### 2.6 FINISH

- A. Class II clear anodized aluminum shall conform to AA-M12-C22-A31.
- B. Class I clear anodized aluminum shall conform to AA-M12-C22-A41.
- C. Class II color anodized aluminum shall conform to AA-M12-C22-A34.
  1. Color: Champagne.
  2. Color: Light Bronze.
  3. Color: Medium Bronze.
  4. Color: Dark Bronze.

## ALUM. SLIDERS - 3

5. Color: Black.
- D. Class I color anodized aluminum shall conform to AA-M12-C22-A44.
1. Color: Champagne.
  2. Color: Light Bronze.
  3. Color: Medium Bronze.
  4. Color: Dark Bronze.
  5. Color: Black.
- E. Fluorocarbon finish complying with AAMA 2605.
1. Resin: 70% PVDF resin shall be Kynar using Kynar500/Hylar5000.
  2. Cleaned and pretreated with chromium phosphate
  3. Coat extrusions with approved primers to minimum dry film thickness of 0.20 mil (.0051 mm).
  4. Color coat shall be a minimum dry film thickness of 1.0 mil (.025 mm).
  5. Approved Coating Manufacturers: PPG Industries or Valspar Corp.

### **PART 3 EXECUTION**

#### 3.1 EXAMINATION

- A. Do not begin installation until substrates have been properly prepared.
- B. If substrate preparation is the responsibility of another installer, notify Architect of unsatisfactory preparation before proceeding.

#### 3.2 PREPARATION

- A. Clean surfaces thoroughly prior to installation.
- B. Prepare surfaces using the methods recommended by the manufacturer for achieving the best result for the substrate under the project conditions.

#### 3.3 INSTALLATION

- A. Install in accordance with manufacturer's instructions.

#### 3.4 FIELD QUALITY CONTROL

- A. Owner will engage an independent AAMA approved testing agency.
- B. Conduct test under the supervision of and in the presence of the Owner, Architect, and Construction Manager.
- C. Test wall in accordance with AAMA 501.2-94.

#### 3.5 PROTECTION

- A. Protect installed products until completion of project.
- B. Touch-up, repair or replace damaged products before Substantial Completion.

END OF SECTION

### **ALUM. SLIDERS - 4**



PRL SL Series is a sliding door system designed as a versatile framed stacking system with a head/sill track, vertical jambs that allows unlimited adaptability with basic single pocket to multi slider configurations for areas where valuable space is critical.

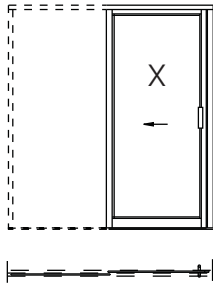

### Pocket System

Pocket system is the SL-series basic configuration, as a one way slider, requires design professionals to consider wall space requirements on pocket applications or the use of an optional custom offset surface mount bracket system for interior applications.

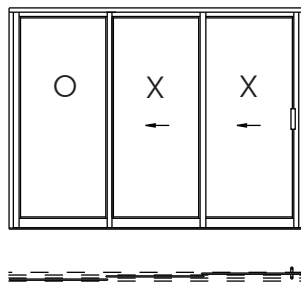

### Wall System

This is the intermediate one way inset surface mount frame configuration that maximizes space on light duty traffic areas.

In addition to the standard SL features it offers a one piece vertical single weather stripped interlock system that reduces slide open efforts on multiple panels at one time.

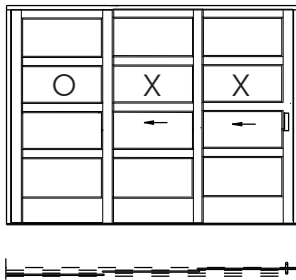

### Custom System

Custom doors will add unlimited design advantages on metal, glass and hardware options. Other optional choices range from custom glass to exotic metal finishes. Stronger reinforced construction permits increasing door heights. Please be advised there is some limitations, please consult PRL Aluminum for details.

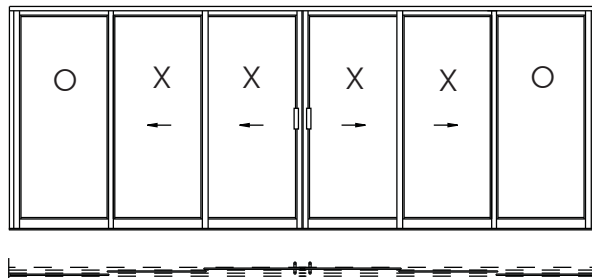

### Multi\_Track System

Multi-Track maximizes the features of the stacking SL concept as a two way, multiple track/panel system with unlimited applications.

Offers both standard and special features from basic configurations.

### Features/Hardware

Bottom adjustable tandem rollers system will ease the open/close sliding efforts. Combination of weather stripped vertical stiles/head track and sill track minimizes the weather effects on exterior applications.

SL series standard hardware are flush handles, hooklock and cylinders. Other types of hardware are offered as options such as flush lockset or custom pulls.



**SLIDING DOORS**  
**1/4"-1" GLASS STOP**  
**FULL SCALE**



**SL-NARROW STYLE**  
 2" VERTICAL STILE

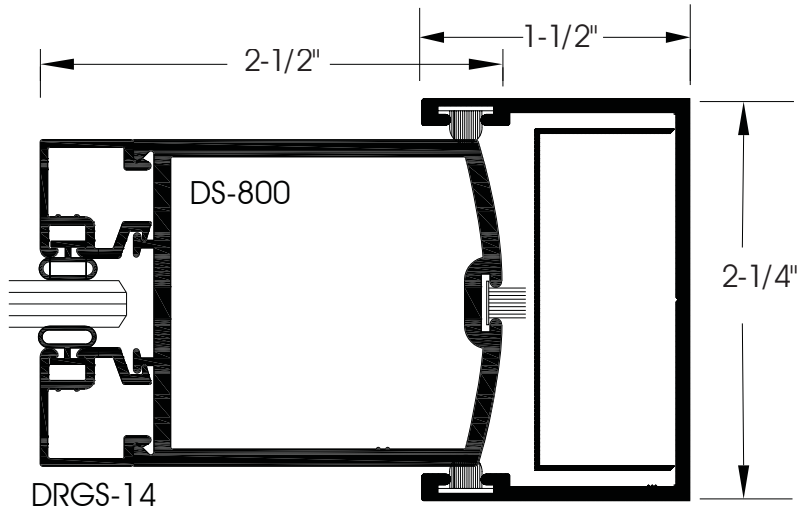

**SL-RADIUS STYLE**  
 1/4" GLASS STOP

**SL-OFFSET STYLE**  
 1/4" GLASS STOP

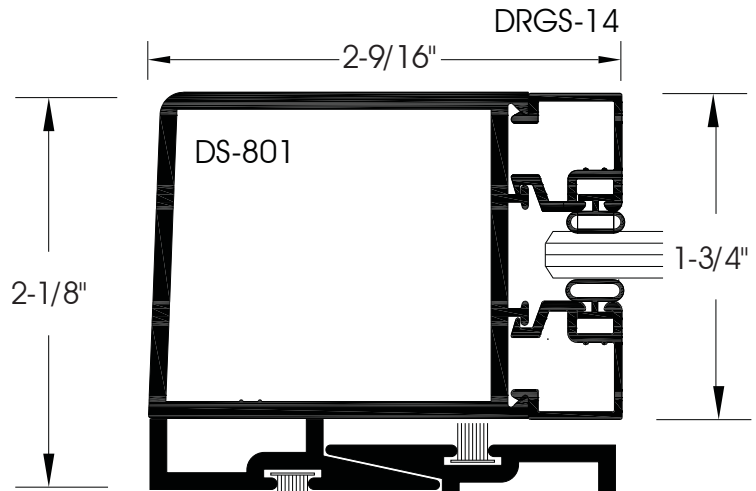

**SL-OFFSET STYLE**  
 1" GLASS STOP

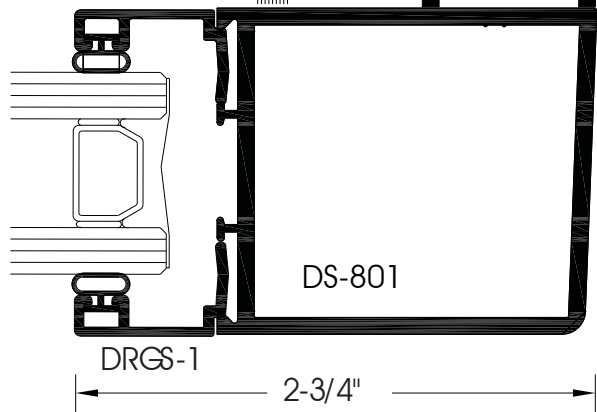

**MATERIAL:** 6063-T5 aluminum alloy.  
**FINISH:** Standard finishes are mill, clear and bronze anodized. All others are special order.  
**NOTES:** Storefronts are available in quick set or screw race, please consult PRL aluminum for details

**ALUM. SLIDERS - 6**

ph: (877) 775-2586  
 fx: (877) 274-8800

14760 Don Julian Rd.  
 Industry, CA 91746

www.prlaluminum.com  
 sales@prlaluminum.com

**SLIDING DOORS**  
**1/4"-1" GLASS STOP**  
**FULL SCALE**



**SL-MEDIUM STYLE**  
 3 1/2" VERTICAL STILE

SL-RADIUS STYLES  
 1" GLASS STOP

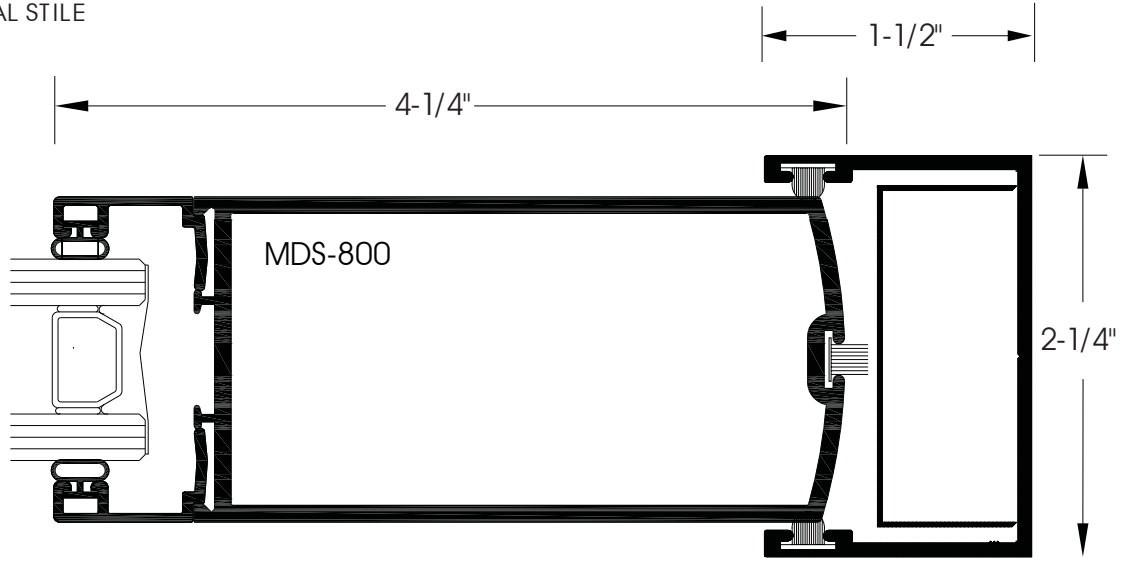

SL-OFFSET STYLE  
 1/4" GLASS STOP

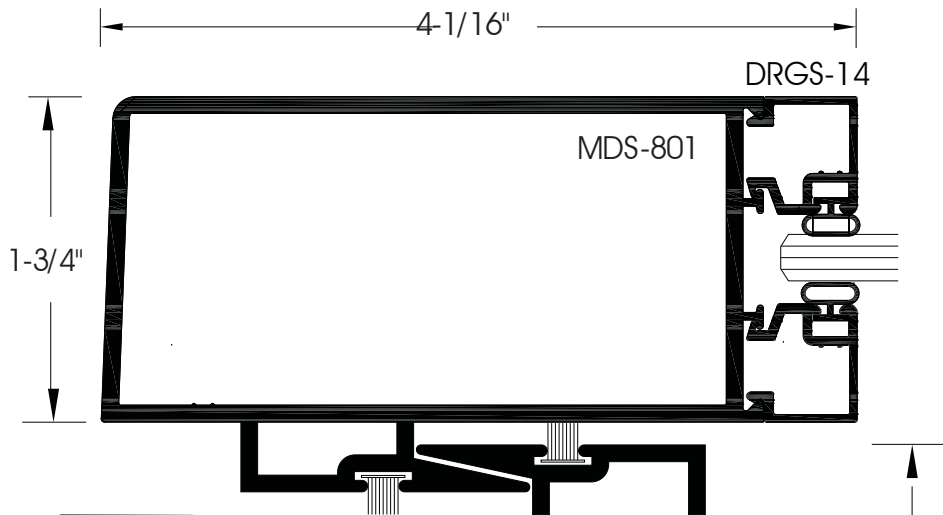

SL-OFFSET STYLE  
 1" GLASS STOP

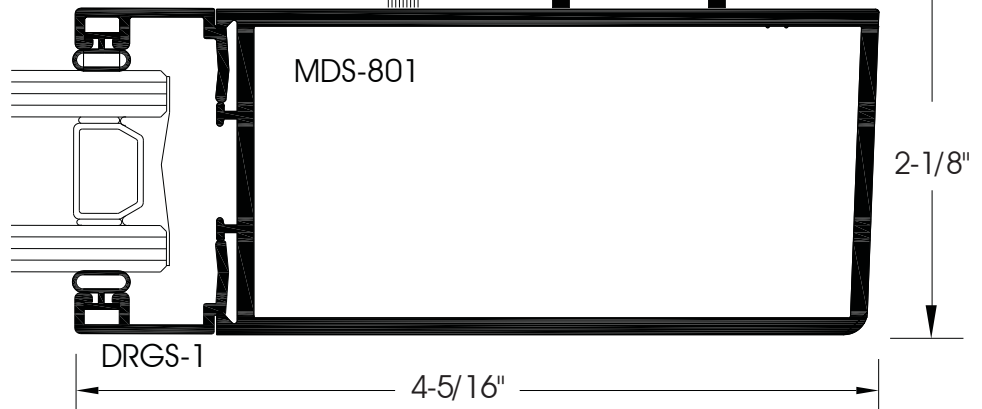

**MATERIAL:** 6063-T5 aluminum alloy.

**FINISH:** Standard finishes are mill, clear and bronze anodized. All others are special order.

**NOTES:** Storefronts are available in quick set or screw race, please consult PRL aluminum for details

**ALUM. SLIDERS - 7**

ph: (877) 775-2586  
 fx: (877) 274-8800

14760 Don Julian Rd.  
 Industry, CA 91746

www.prlaluminum.com  
 sales@prlaluminum.com

**SLIDING DOORS**  
**1/4"-1" GLASS STOP**  
**FULL SCALE**



**SL-WIDE STYLE**  
 3 1/2" VERTICAL STILE

SL-RADIUS STYLES  
 1" GLASS STOP

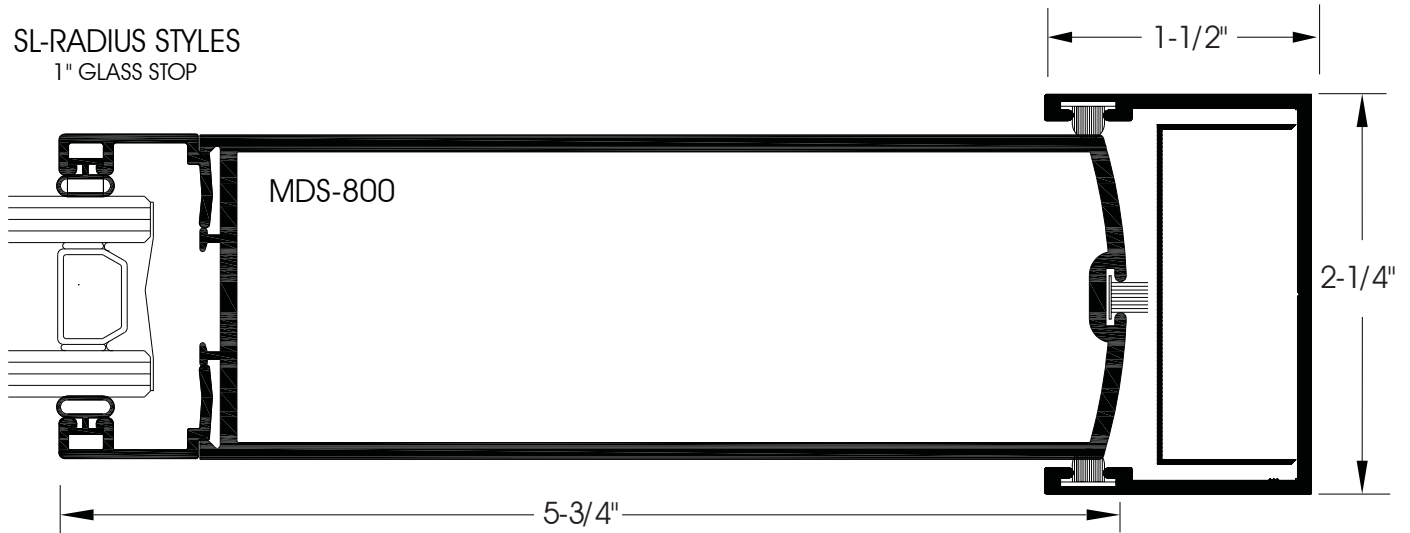

SL-OFFSET STYLE  
 1/4" GLASS STOP

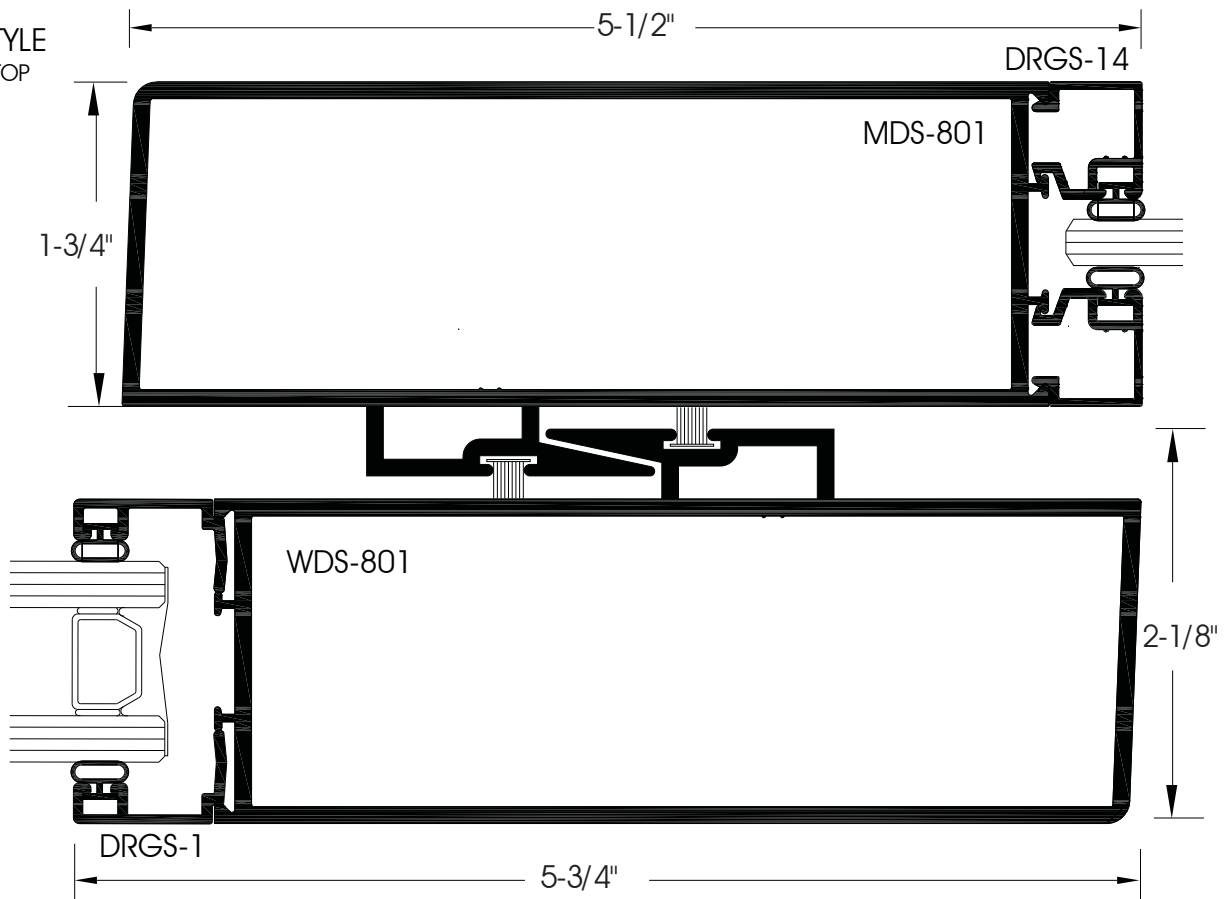

**MATERIAL:** 6063-T5 aluminum alloy.

**FINISH:** Standard finishes are mill, clear and bronze anodized. All others are special order.

**NOTES:** Storefronts are available in quick set or screw race, please consult PRL aluminum for details

**ALUM. SLIDERS - 8**

ph: (877) 775-2586  
 fx: (877) 274-8800

14760 Don Julian Rd.  
 Industry, CA 91746

www.prlaluminum.com  
 sales@prlaluminum.com

SLIDING DOORS  
 1/4"-1" GLASS STOP  
 FULL SCALE



SL- STYLE  
 3 1/4" RAIL

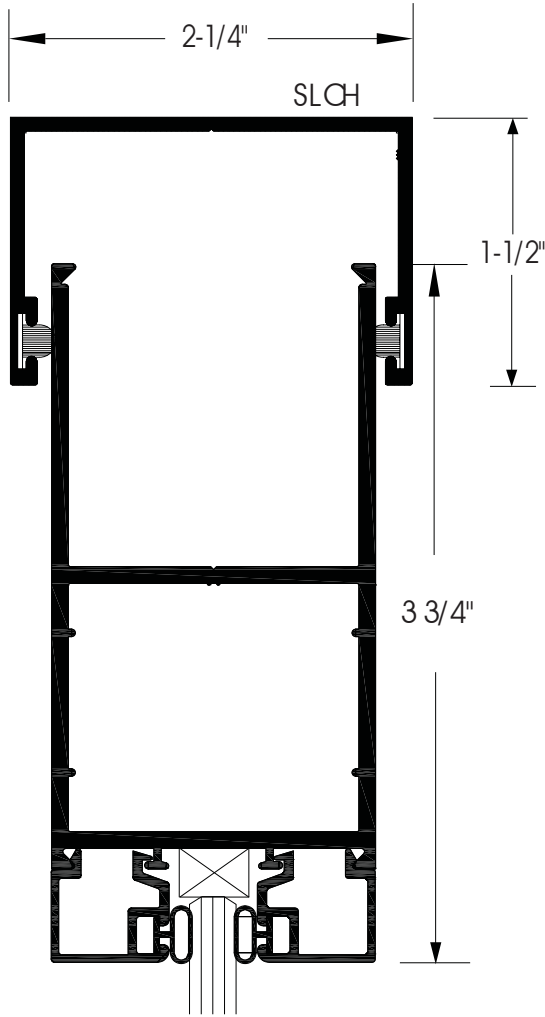

SL-TOP  
 RAIL  
 1/4" GLASS STOP

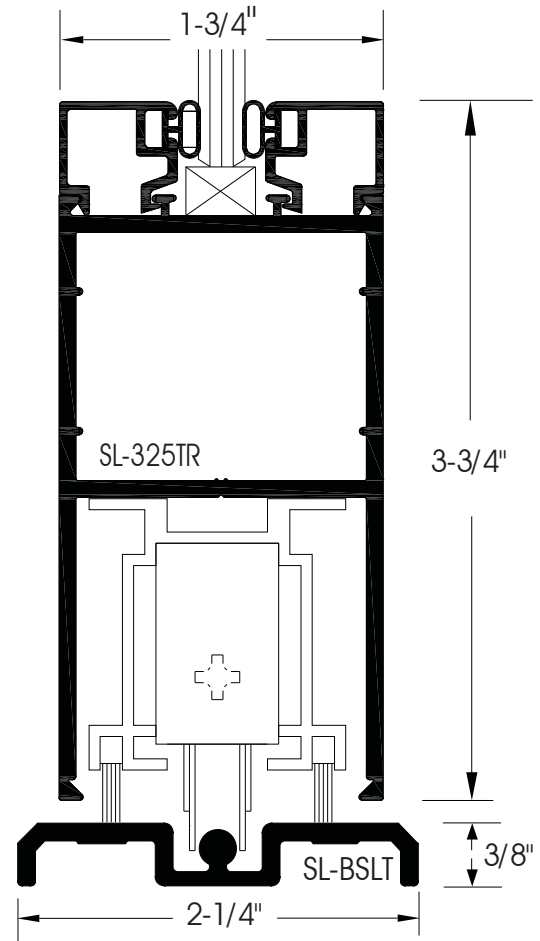

SL-BOTTOM  
 RAIL  
 1/4" GLASS STOP

**MATERIAL:** 6063-T5 aluminum alloy.

**FINISH:** Standard finishes are mill, clear and bronze anodized. All others are special order.

**NOTES:** Storefronts are available in quick set or screw race, please consult PRL aluminum for details

**ALUM. SLIDERS - 9**

ph: (877) 775-2586  
 fx: (877) 274-8800

14760 Don Julian Rd.  
 Industry, CA 91746

www.praluminum.com  
 sales@praluminum.com

SLIDING DOORS  
 1/4"-1" GLASS STOP  
 FULL SCALE



SL- STYLE  
 3 1/4" RAIL

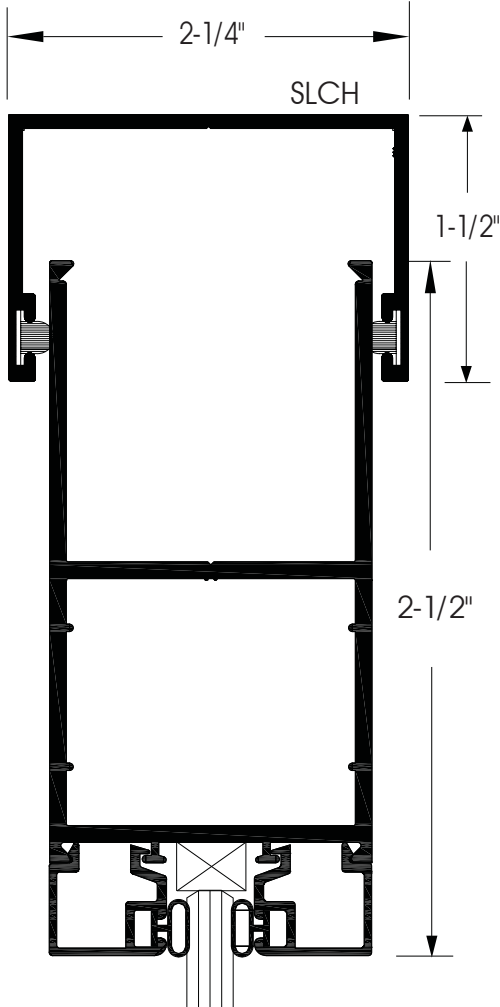

SL-TOP  
 RAIL  
 1/4" GLASS STOP

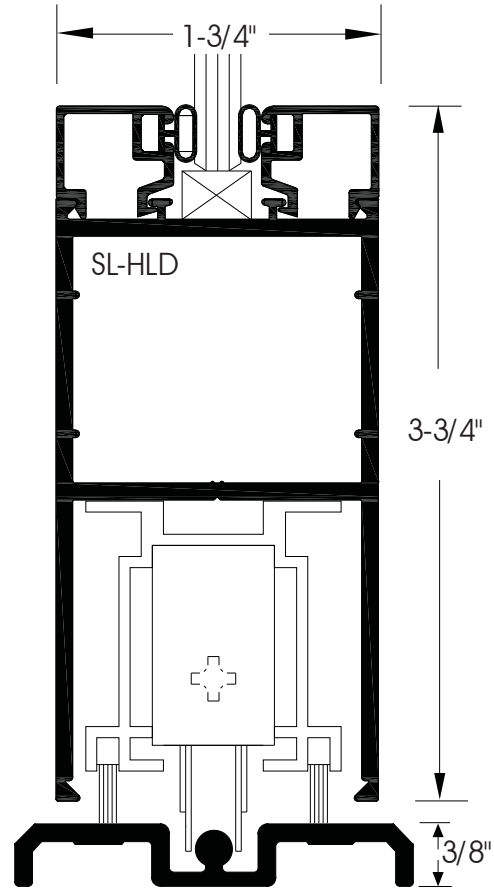

SL-BOTTOM  
 RAIL  
 1/4" GLASS STOP

**MATERIAL:** 6063-T5 aluminum alloy.

**FINISH:** Standard finishes are mill, clear and bronze anodized. All others are special order.

**NOTES:** Storefronts are available in quick set or screw race, please consult PRL aluminum for details

ALUM. SLIDERS - 10

14760 Don Julian Rd.  
 Industry, CA 91746

ph: (877) 775-2586  
 fx: (877) 274-8800

www.prlaluminum.com  
 sales@prlaluminum.com

SLIDING DOORS  
 1/4"-1" GLASS STOP  
 FULL SCALE



SL- STYLE  
 3 1/4" RAIL

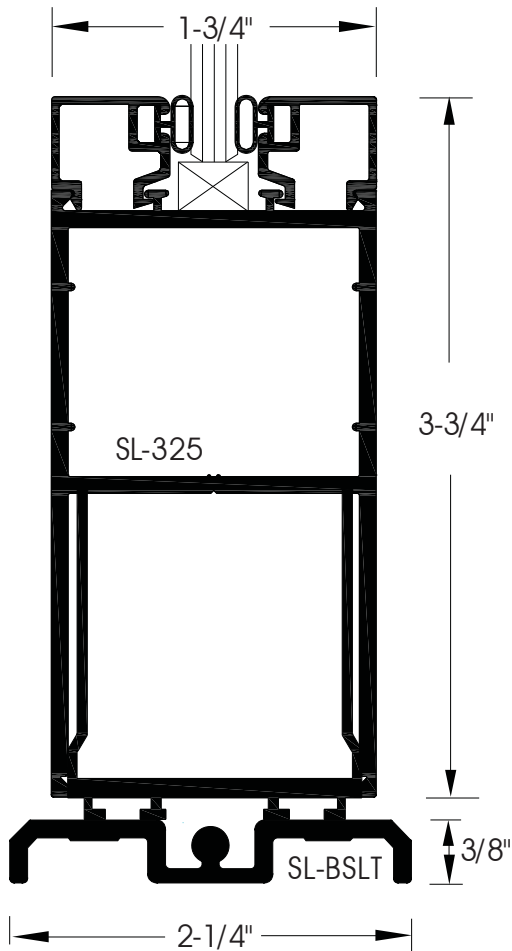

SL-BOTTOM RAIL  
 + BULK HEAD  
 1/4" GLASS STOP

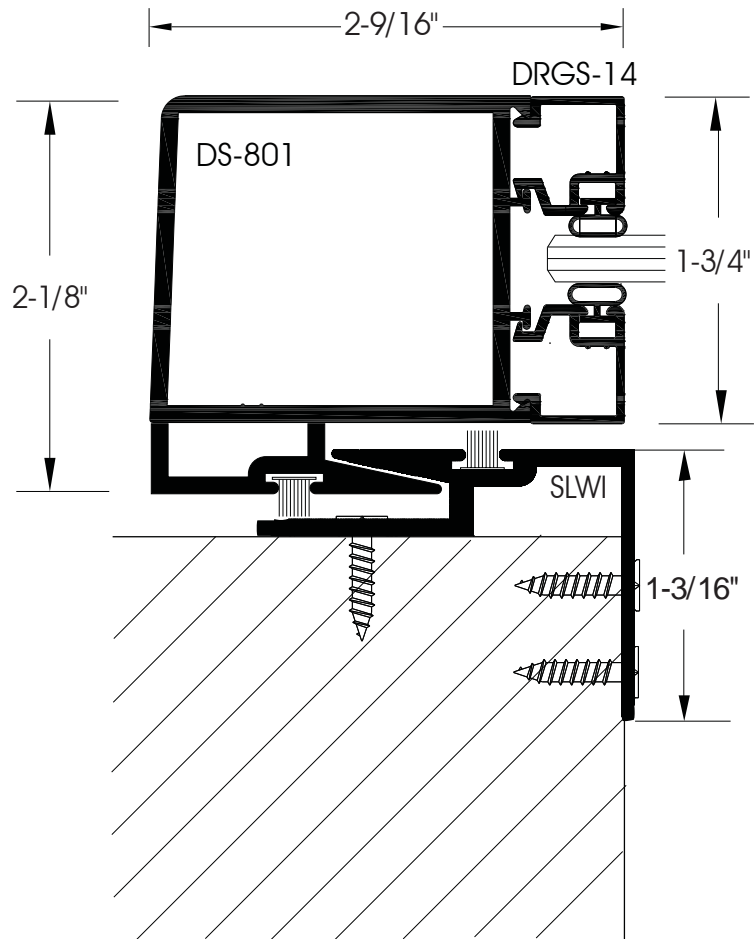

SL-STILE  
 1" GLASS STOP

**MATERIAL:** 6063-T5 aluminum alloy.

**FINISH:** Standard finishes are mill, clear and bronze anodized. All others are special order.

**NOTES:** Storefronts are available in quick set or screw race, please consult PRL aluminum for details

ALUM. SLIDERS - 11

14760 Don Julian Rd.  
 Industry, CA 91746

ph: (877) 775-2586  
 fx: (877) 274-8800

www.prlaluminum.com  
 sales@prlaluminum.com



**SLIDING DOORS**  
**1/4"-1" GLASS STOP**  
**FULL SCALE**



**WALL SYSTEM  
 DETAILS**

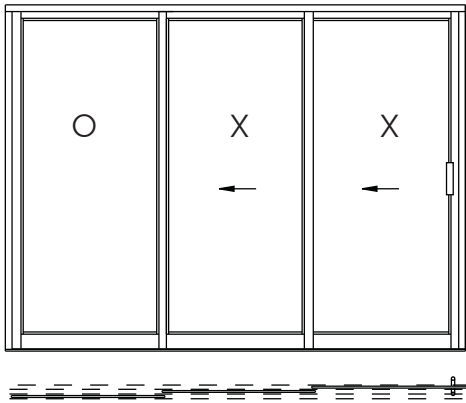

**INTERLOCKED  
 WALL SYSTEM  
 HEAT ELEVATION**

**SL-JAMB**

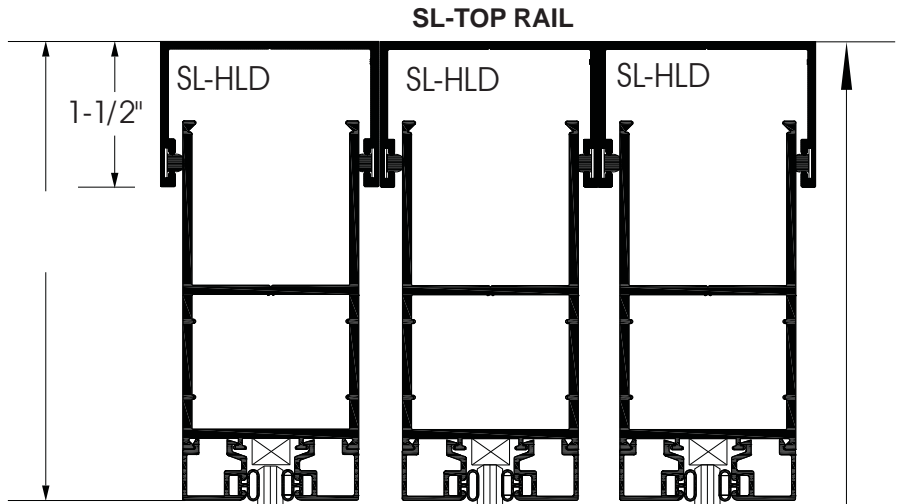
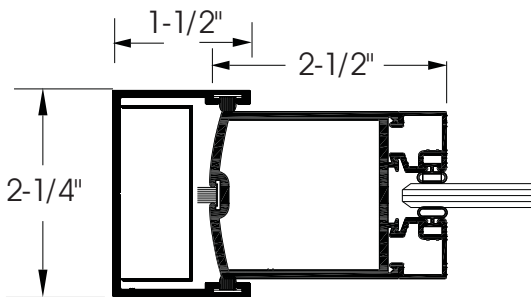

**SL-TOP RAIL**

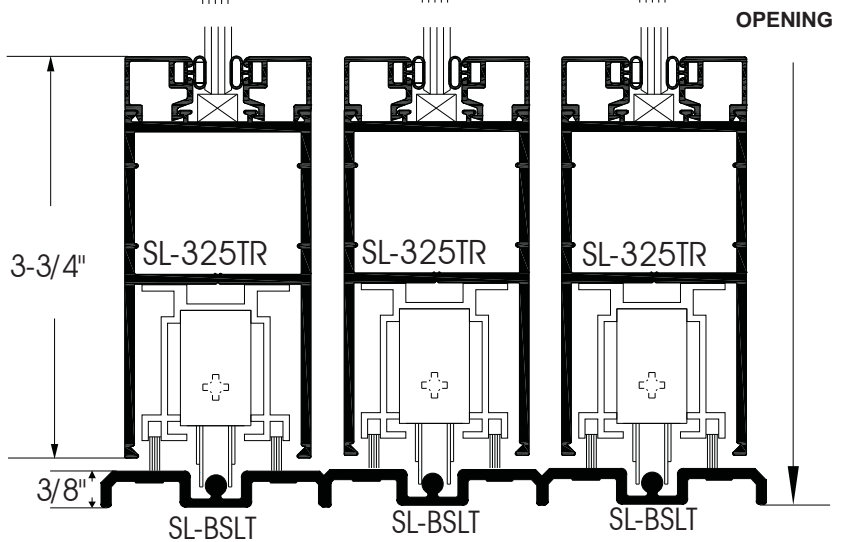

**VERTICAL SECTION**

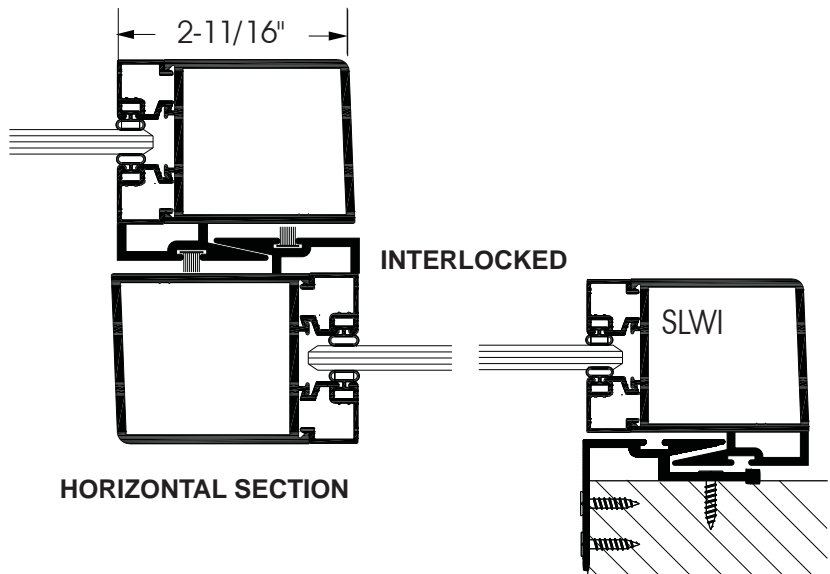

**HORIZONTAL SECTION**

**ALUM. SLIDERS - 12**

14760 Don Julian Rd.  
 Industry, CA 91746

ph: (877) 775-2586  
 fx: (877) 274-8800

[www.prlaluminum.com](http://www.prlaluminum.com)  
[sales@prlaluminum.com](mailto:sales@prlaluminum.com)

**SLIDING DOORS**  
**1/4"-1" GLASS STOP**  
**FULL SCALE**



**WALL SYSTEM  
 DETAILS**

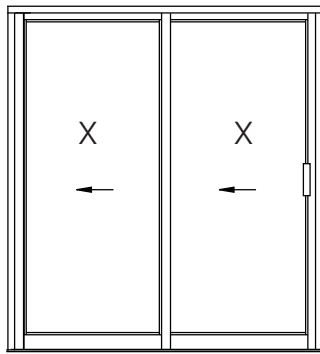

**SLIDER WALL SYSTEM  
 ELEVATION**

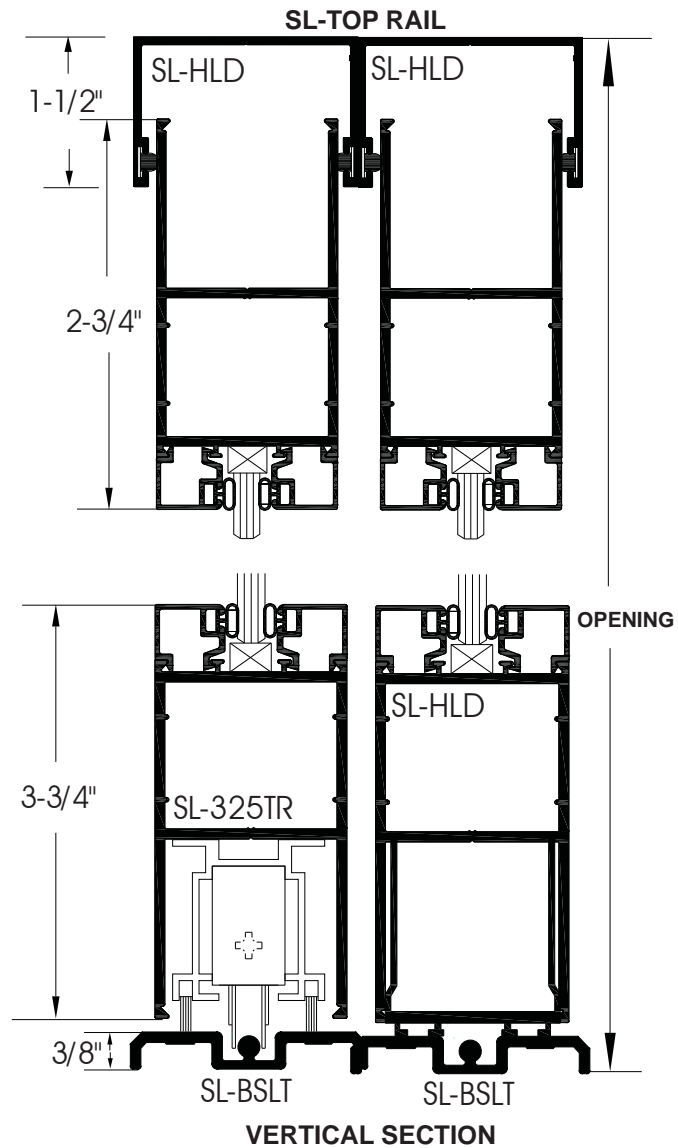

**VERTICAL SECTION**

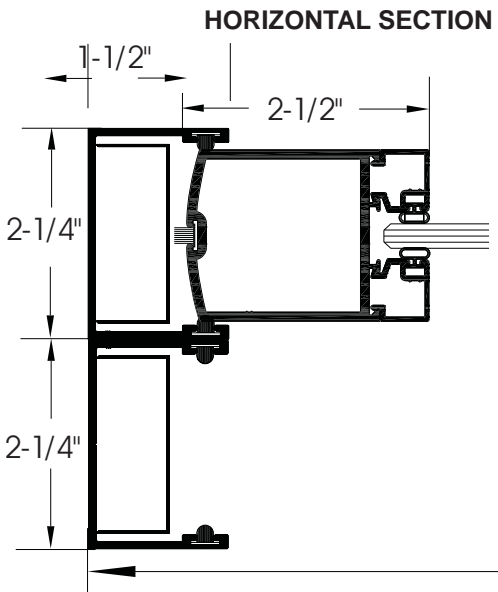

**HORIZONTAL SECTION**

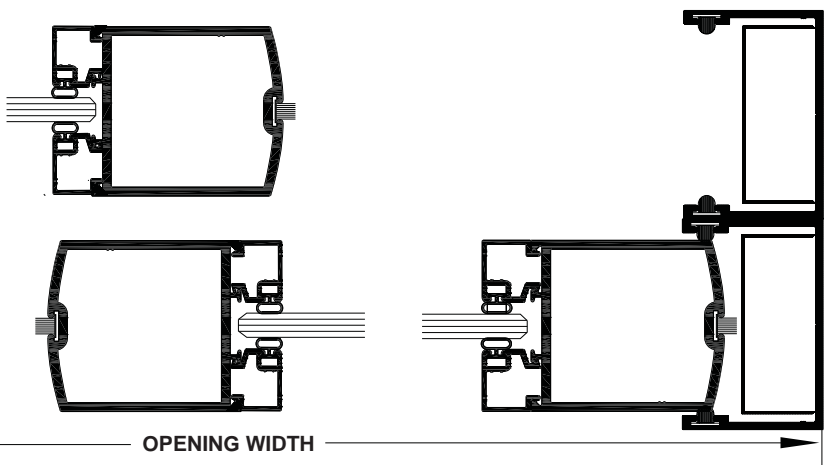

**OPENING WIDTH**

**ALUM. SLIDERS - 13**

ph: (877) 775-2586  
 fx: (877) 274-8800

14760 Don Julian Rd.  
 Industry, CA 91746

www.prlaluminum.com  
 sales@prlaluminum.com

# **BREAKMETAL SECTION**

# **BREAKMETAL SECTION**



## BRAKE SHAPES



STANDARD LENGTHS: 8', 10', 12'  
(ALL 48" IN WIDTH)

### INVENTORY SHEET LIST

THICKNESS		THICKNESS		THICKNESS	
.040	MILL FINISH	.040	DARK BRONZE ANO.	.050	#4 BRUSHED MUNTZ
.050	MILL FINISH	.050	DARK BRONZE ANO.	12 GA	#8 MIRROR S/S
.063	MILL FINISH	.063	DARK BRONZE ANO.	14 GA	#8 MIRROR S/S
.090	MILL FINISH	.125	DARK BRONZE ANO.	16 GA	#8 MIRROR S/S
.125	MILL FINISH	.040	BLACK ANO.	18 GA	#8 MIRROR S/S
.040	CLEAR ANO.	.040	POLAR WHITE	20 GA	#8 MIRROR S/S
.050	CLEAR ANO.	.050	POLAR WHITE	14 GA	#4 BRUSHED S/S
.063	CLEAR ANO.	.063	POLAR WHITE	16 GA	#4 BRUSHED S/S
.125	CLEAR ANO.	.045	#8 MIRROR NAVAL BRASS	18 GA	#4 BRUSHED S/S
.040	BRIGHT CLEAR ANO.	.045	#4 BRUSHED NAVAL BRASS	20 GA	#4 BRUSHED S/S
.040	BRIGHT GOLD ANO.	.050	#8 MIRROR MUNTZ		

(14' LENGTHS ARE SUBJECT TO AVAILABILITY, PLEASE CALL TO VERIFY STOCK)

We offer Shear and Brake Metal

#### CUSTOM SHAPES

- HEAD/SILL FLASHING
- ANGLES
- HAT
- J-Z SHAPES
- OPEN/CLOSED CORNER
- CHANNEL

#### HANDRAIL

- TOP CAP
- MITER RETURN/CORNERS
- CONNECTORS

#### CUSTOM WELDING

- TACK WELDING

#### METAL FINISHING

- MIRROR POLISHING
- DIRECTIONAL SATIN BRUSH

#### CLAD

- FULL FRAME DOORS
- DOOR HEADER/JAMBS/T-HOLDS
- STOREFRONT FRAMING
- CANOPY
- COLUMN COVERS
- CORNICES
- PANEL PANS



CONSULT PRL FOR PRICES ON EXTENSIVE PROJECTS

NOTES: PRICES ARE SUBJECT TO CHANGE WITHOUT NOTICE REV 5/05  
PMATERIAL IS SUBJECT TO FABRICATION LIMITATIONS PLEASE CONSULT PRL ALUMINUM FOR DETAILS

ph: (877) 775-2586  
fx: (877) 274-8800

**BREAKMETAL - 01**  
14760 Don Julian Rd.  
Industry, CA 91746

www.prlaluminum.com  
sales@prlaluminum.com



# **HARDWARE SECTION**

# **HARDWARE SECTION**



**WE OFFER THE FASTEST  
LEADTIMES GUARANTEED!**

**(800)433-7044**



**CUSTOM DOORS**

**WE OFFER AN EXTENSIVE  
LINE OF HARDWARE THAT  
FACILITATE A SAFE AND  
EASY DOOR OPERATION.**

**OFFERS AN UNLIMITED  
ADAPTABILITY  
TO DESIGN CONCEPTS**

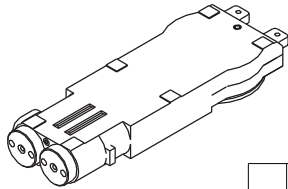

**CLOSERS**

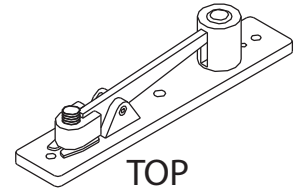

**TOP  
PIVOTS**

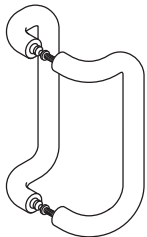
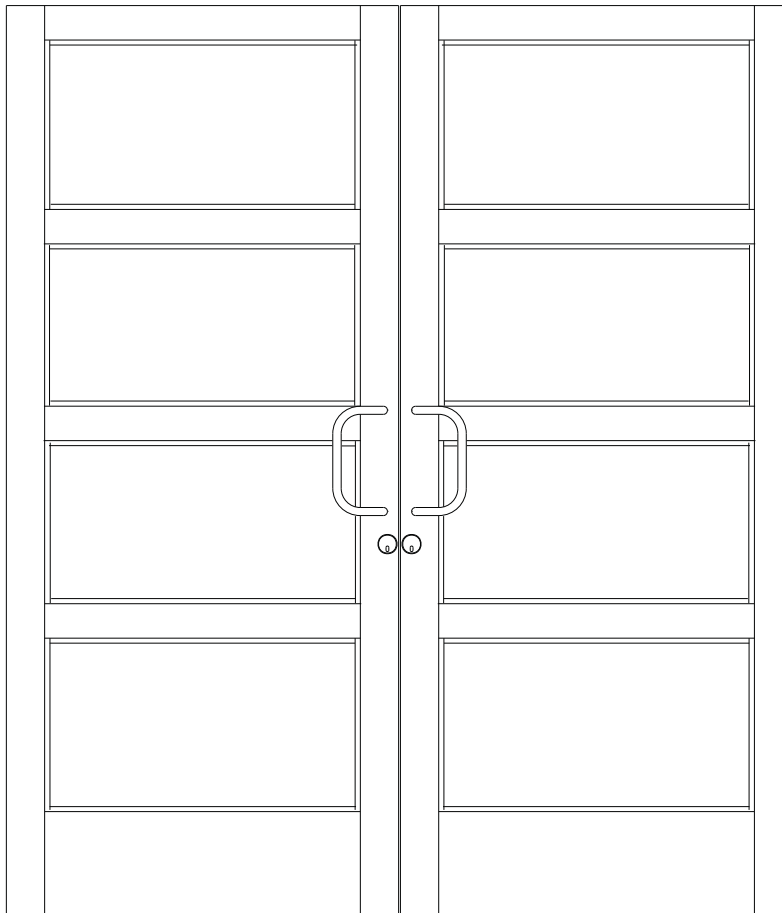

**PULLS**

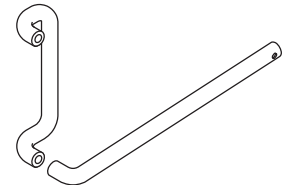

**SB-PUSH/PULLS**

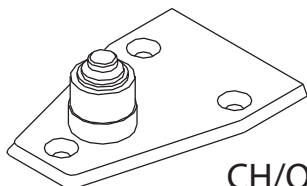

**CH/OFFSET**

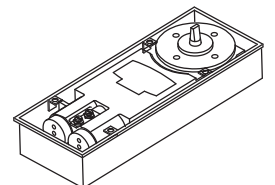

**FLOOR CLOSERS**

**ALL PRICES ARE SUBJECT TO  
CHANGE WITHOUT NOTICE**

**ph: (877) 775-2586  
fx: (877) 274-8800**

**HARDWARE - 01  
14760 Don Julian Rd.  
Industry, CA 91746**

**www.prlaluminum.com  
sales@prlaluminum.com**

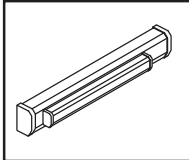
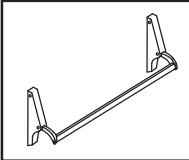

**HARDWARE**

PANICS NAME PART NUMBER UNIT			FREE LOCAL DELIVERY! ON ORDERS ABOVE \$500.00	ADAMS RITE devices and other mfr's are also available upon request! *call for details
	CONTEMPO	CROSS BAR		
	CPN	CBPN		
	PC/EA	PC/EA		

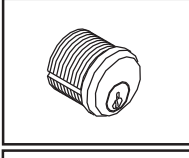
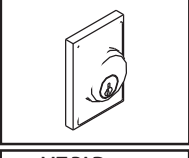
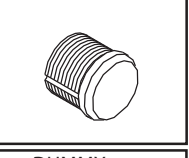
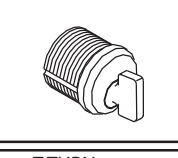
CYLINDERS NAME PRT NUMBER UNIT				
	KEY	MT-PAD	DUMMY	T-TURN
	KC	MP	DC	TT
	PC/EA	PC/EA	PC/EA	PC/EA

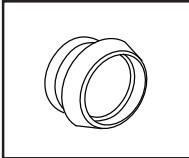
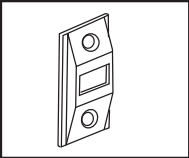
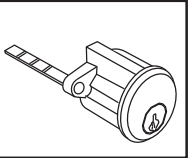
NAME PART NUMBER UNIT				ORDER a complete system! GLASS & ALUMINUM from US *call for details
	CYL GUARD	LOCK INDICATOR	RIM CYLINDER	
	CG	LI	RC	
	PC/EA	PC/EA	PC/EA	

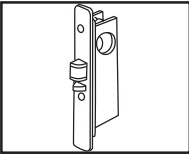
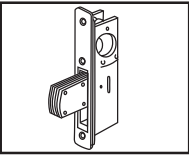
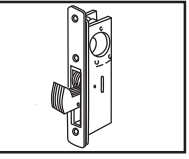
LOCKS NAME PART NUMBER UNIT				T-HOLD & HEADER BOLTS are also in stock! *call for details
	DEADLATCH	LONG THROW	HOOK THROW	
	DL	LT	HT	
	PC/EA	PC/EA	PC/EA	

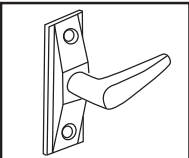
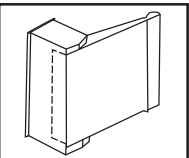
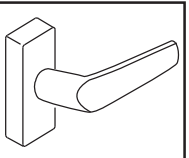
HANDLES NAME PART NUMBER UNIT				Please call us for specific lever/handle MFR/models
	LEVER	PADDLE	EURO LEVER	
	LH	PH	ELH	
	PC/EA	PC/EA	PC/EA	

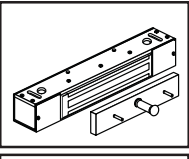
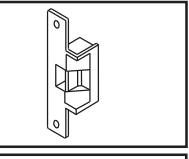
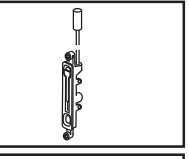
ACCESSORIES NAME PART NUMBER UNIT				INTERNATIONAL and other access controls are also available upon request! *call for details
	MAGNETIC LOCK	ELECTRIC STRIKE	FLUSH BOLT	
	ML	ES	FB	
	PC/EA	PC/EA	PC/EA	

NOTE: PLEASE CALL PRL ALUMINUM FOR DETAILS ON FINISHES

**HARDWARE - 02**

14760 Don Julian Rd.  
 Industry, CA 91746

ph: (877) 775-2586  
 fx: (877) 274-8800

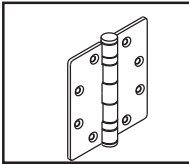
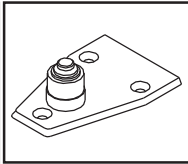
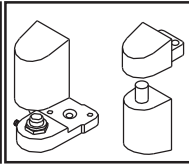
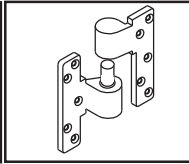

www.prlaluminum.com  
 sales@prlaluminum.com

**HARDWARE**

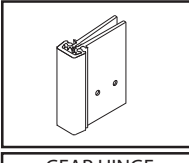
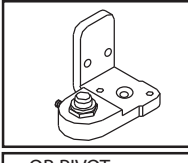
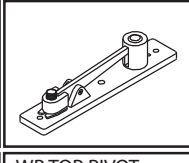
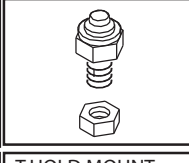
PIVOTS				
	NAME BH	NAME CHBP	NAME OP	NAME IPV
	PART NUMBER PC/EA	PART NUMBER PC/EA	PART NUMBER SET	PART NUMBER PC/EA

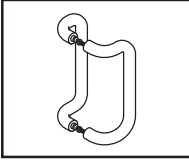
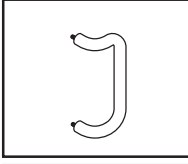
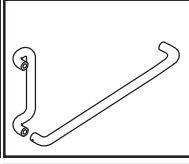
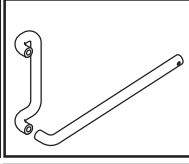
NAME				
	NAME GH	NAME OBP	NAME WBTP	NAME THMP
	PART NUMBER PC/EA	PART NUMBER PC/EA	PART NUMBER PC/EA	PART NUMBER PC/EA

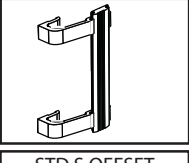
PULLS				
	NAME BBOP	NAME SSOP	NAME DBPP	NAME SBPP
	PART NUMBER PC/EA	PART NUMBER PC/EA	PART NUMBER PC/EA	PART NUMBER PC/EA

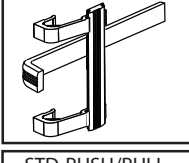
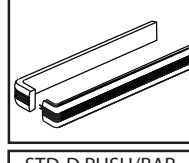
NAME				
	NAME SSOP	NAME SPB	NAME SPPB	NAME SDPB
	PART NUMBER PC/EA	PART NUMBER PC/EA	PART NUMBER PC/EA	PART NUMBER PC/EA

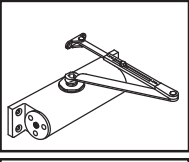
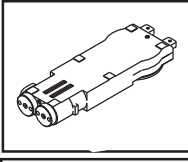
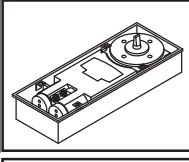
CLOSERS				FREE LOCAL DELIVERY! ON ORDERS ABOVE \$500.00
	NAME SMC	NAME OHCC	NAME FC	
	PART NUMBER PC/EA*	PART NUMBER PC/EA	PART NUMBER PC/EA	

\*MOUNTING BRACKET SOLD SEPARATELY

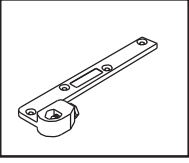
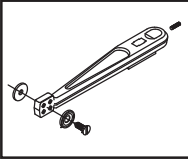
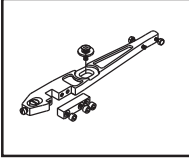
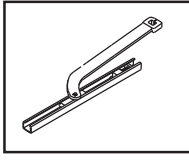
ARMS				
	NAME FCOA	NAME FCA	NAME OHA	NAME OHOA
	PART NUMBER PC/EA	PART NUMBER PC/EA	PART NUMBER PC/EA	PART NUMBER PC/EA

NOTE: PLEASE CALL PRL ALUMINUM FOR DETAILS ON FINISHES

**HARDWARE - 03**