

PRL GLASS SYSTEMS INC.

Web Site: www.prlglass.com

www.prlaluminum.com

Telephone : (877) 775-25856
 Fax No. : (626) 968-95256

251 Mason Way
 City of industry, C.A.

TITLE **MAX Slider**
details

MAX Slider
 XXO
 bottom rolling
 elevation

ELEVATION 101



SCALE **XXXXX**

DATE **2/22/2011**

DRAWING NAME
MAX Slider details 1_1-4 IG.dwg

DRAFTPERSON **P**



1
101.A

VERTICAL CUT SECTION
AT DOOR / HEAD



REFERENCE

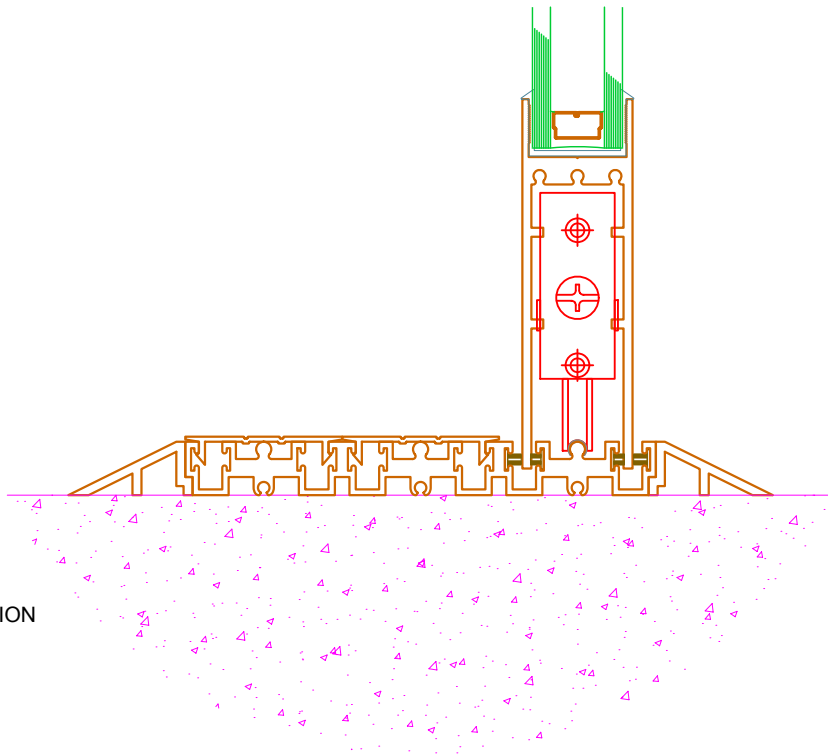
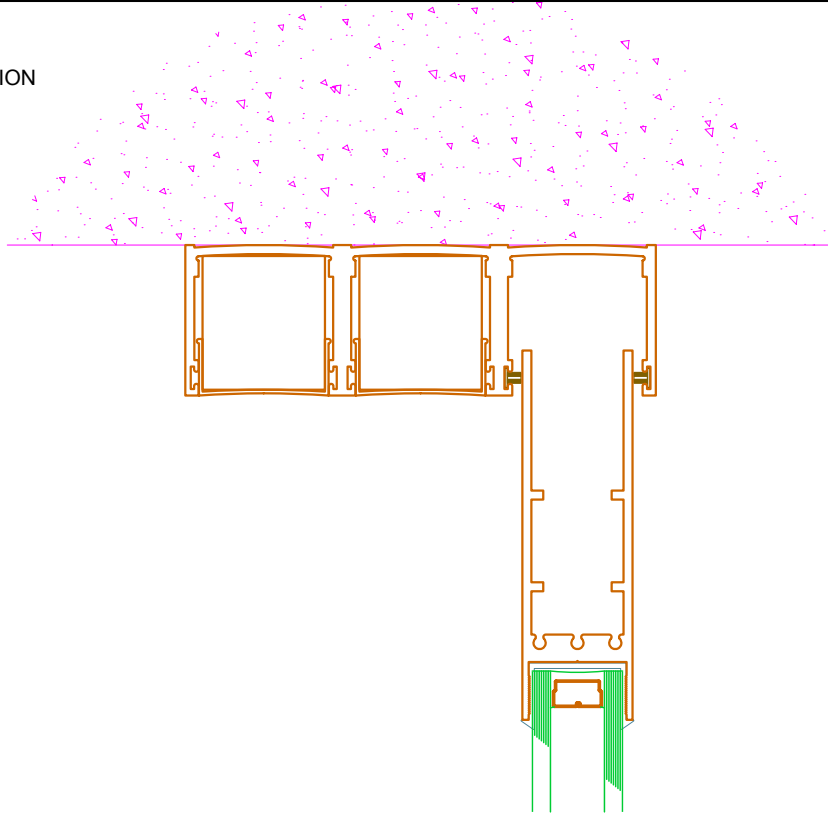

2
101.A

VERTICAL CUT SECTION
AT DOOR / SILL



REFERENCE

PRL GLASS SYSTEMS INC.

Web Site: www.prlglass.com

www.prlaluminum.com

Telephone : (877) 775-25856
Fax No. : (626) 968-95256

251 Mason Way
City of industry, C.A.

TITLE **MAX Slider**
details

MAX Slider
XXO
bottom rolling
vertical section
1-1/4" I.G.

101.A



SCALE **XXXXX**

DATE **2/22/2011**

DRAWING NAME
MAX Slider details 1_1-4 IG.dwg

DRAFTPERSON **P**



1
101.B

VERTICAL CUT SECTION
AT DOOR / HEAD



REFERENCE

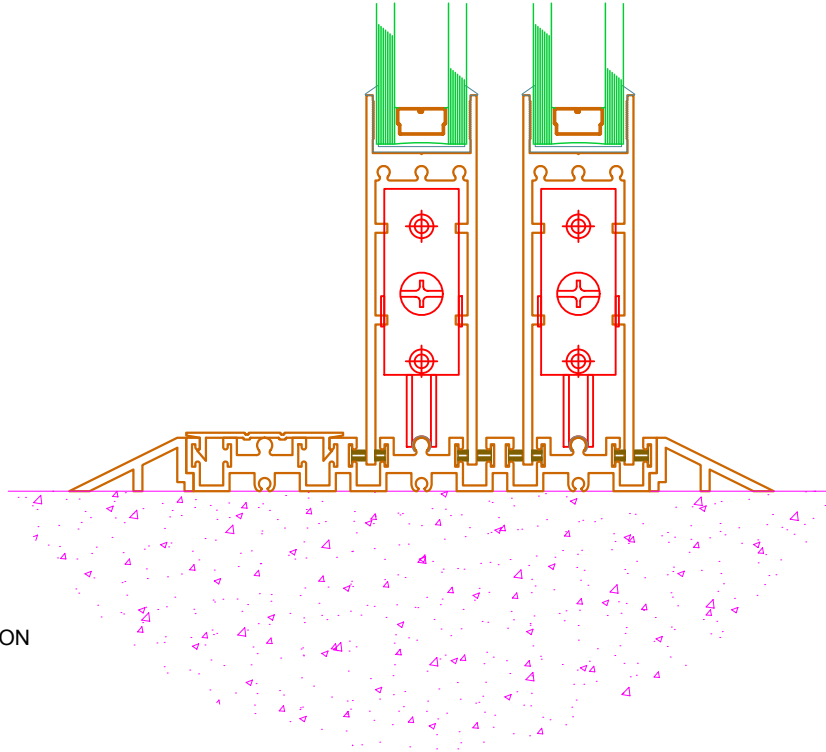
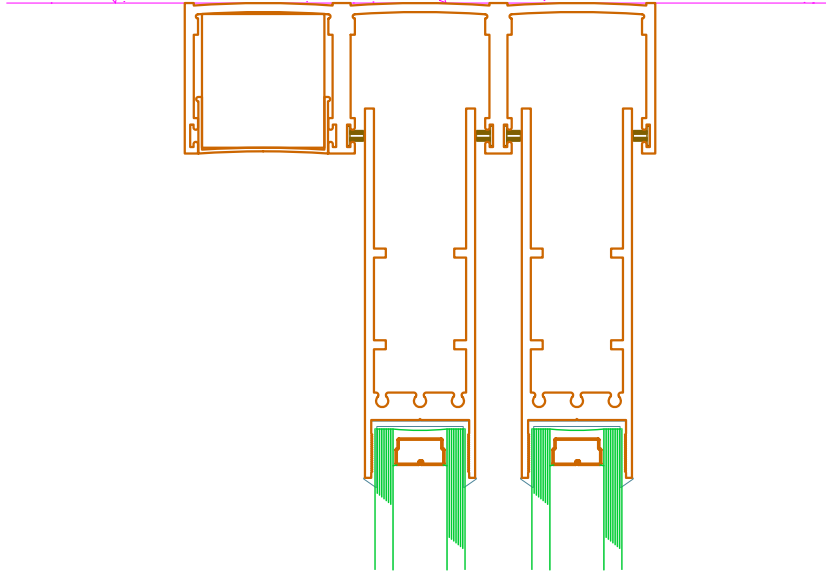

2
101.B

VERTICAL CUT SECTION
AT DOOR / SILL



REFERENCE

PRL GLASS SYSTEMS INC.

Web Site: www.prlglass.com

www.prlaluminum.com

Telephone : (877) 775-25856
Fax No. : (626) 968-95256

251 Mason Way
City of industry, C.A.

TITLE **MAX Slider**
details

MAX Slider
XXO
bottom rolling
vertical section
1-1/4" I.G.

101.B



SCALE **XXXXX**

DATE **2/22/2011**

DRAWING NAME
MAX Slider details 1_1-4 IG.dwg

DRAFTPERSON **P**



1
101.C

VERTICAL CUT SECTION
AT SIDELITE / HEAD



REFERENCE

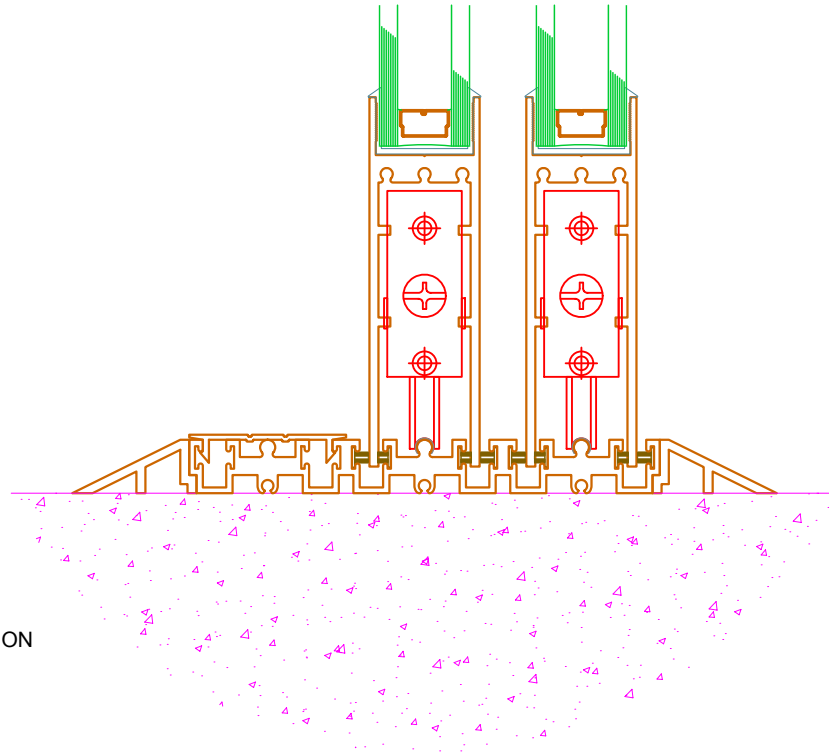
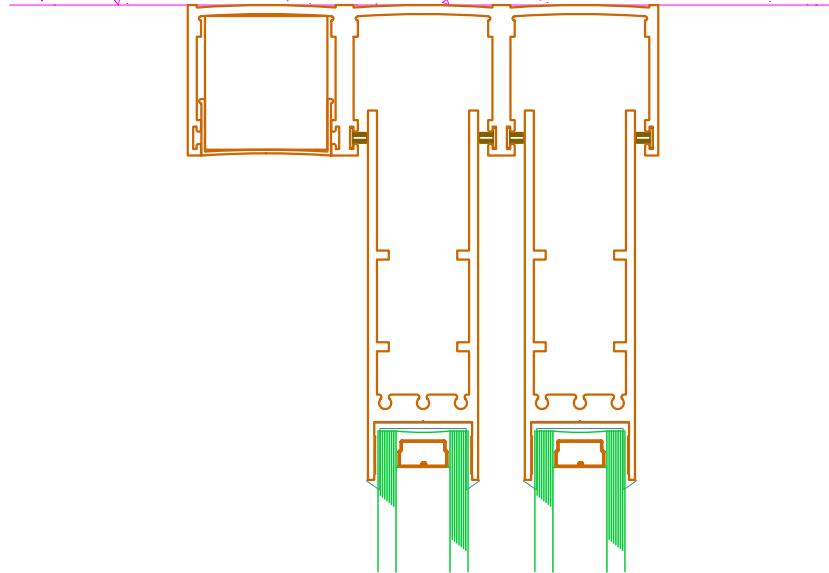

2
101.C

VERTICAL CUT SECTION
AT SIDELITE / SILL



REFERENCE

PRL GLASS SYSTEMS INC.

Web Site: www.prlglass.com

www.prlaluminum.com

Telephone : (877) 775-25856
Fax No. : (626) 968-95256

251 Mason Way
City of industry, C.A.

TITLE **MAX Slider**
details

MAX Slider
XXO
bottom rolling
vertical section
1-1/4" I.G.

101.C



SCALE **XXXXX**

DATE **2/22/2011**

DRAFTPERSON **P**



DRAWING NAME
MAX Slider details 1_1-4 IG.dwg

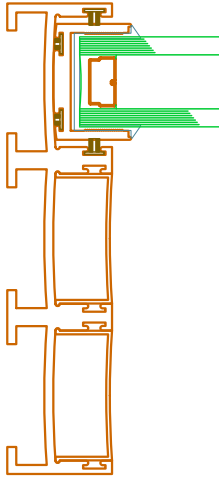

1
101.D HORIZONTAL CUT SECTION
AT DOOR STRIKE

REFERENCE

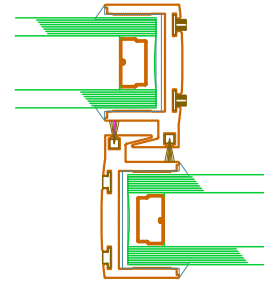

2
101.D HORIZONTAL CUT SECTION
AT DOOR INTERLOCK STYLE

REFERENCE

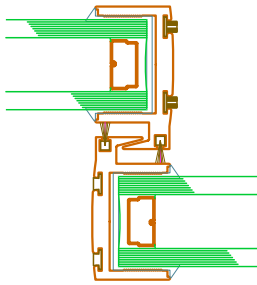

3
101.D HORIZONTAL CUT SECTION
AT DOOR INTERLOCK STYLE

REFERENCE

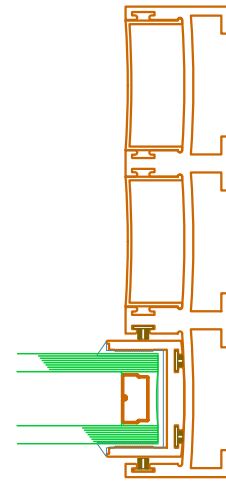

4
101.D HORIZONTAL CUT SECTION
AT SIDELITE / JAMB

REFERENCE

PRL GLASS SYSTEMS INC.

Web Site: www.prlglass.com

www.prlaluminum.com

Telephone : (877) 775-25856
Fax No. : (626) 968-95256

251 Mason Way
City of industry, C.A.

TITLE **MAX Slider**
details

MAX Slider
XXO
bottom rolling
vertical section
1-1/4" I.G.

101.D



SCALE **XXXXX**

DATE **2/22/2011**

DRAFTPERSON **P**



DRAWING NAME
MAX Slider details 1_1-4 IG.dwg

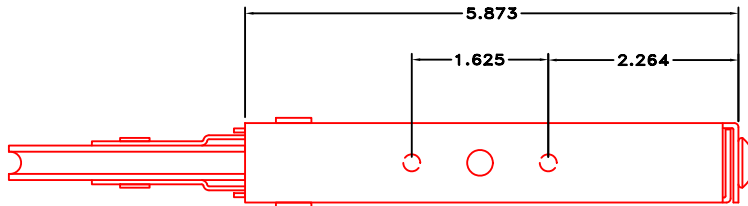

top view

NOTE: Only use this roller with glazed MAX Slider

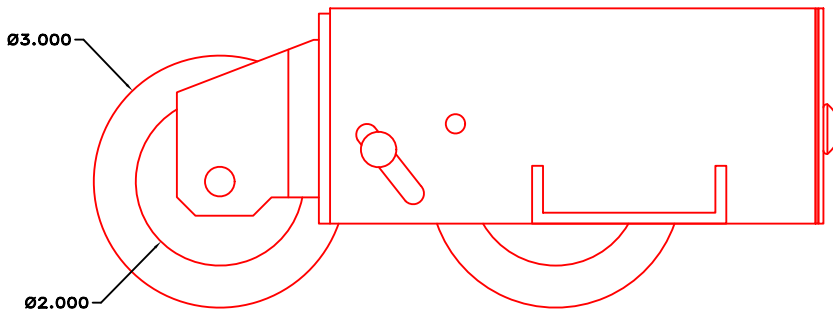

front view

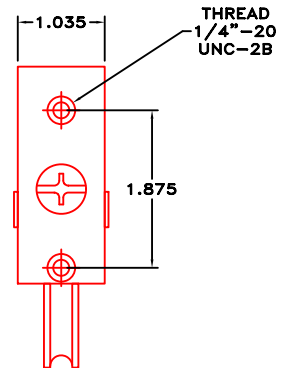

side view

PRL GLASS SYSTEMS INC.

Web Site: www.prlglass.com

www.prlaluminum.com

Telephone : (877) 775-25856
Fax No. : (626) 968-95256

251 Mason Way
City of industry, C.A.

TITLE **MAX Slider**

details

SCALE **XXXXX**

DATE **2/22/2011**

DRAFTPERSON **P**



MAX Slider
mammoth
tandem bottom roller

mammoth tandem roller

DRAWING NAME
MAX Slider details 1_1-4 IG.dwg



NOTE:
 this roller can only be used
 with MAX Slider screen door, not glazed door

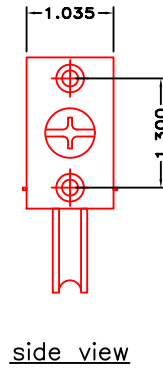
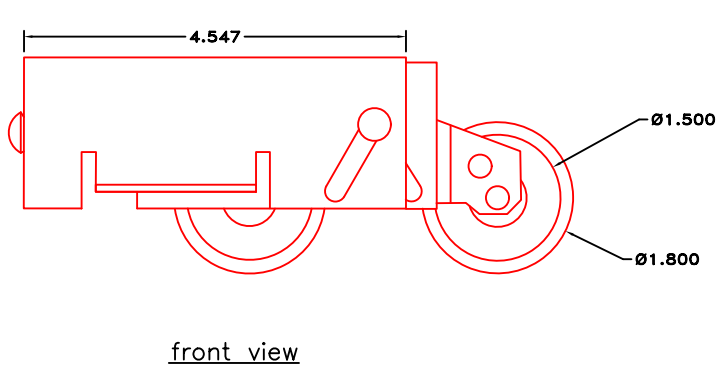
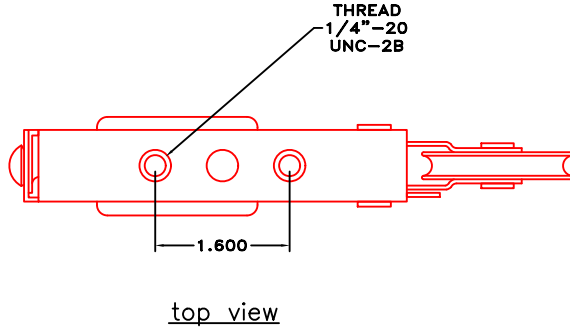

PRL GLASS SYSTEMS INC.

Web Site: www.prlglass.com

www.prlaluminum.com

Telephone : (877) 775-25856
 Fax No. : (626) 968-95256

251 Mason Way
 City of industry, C.A.

TITLE **MAX Slider**

details

SCALE **XXXXX**

DATE **2/22/2011**

DRAFTPERSON **P**



MAX Slider
 optional
 tandem bottom roller

standard tandem roller

DRAWING NAME
MAX Slider details 1_1-4 IG.dwg



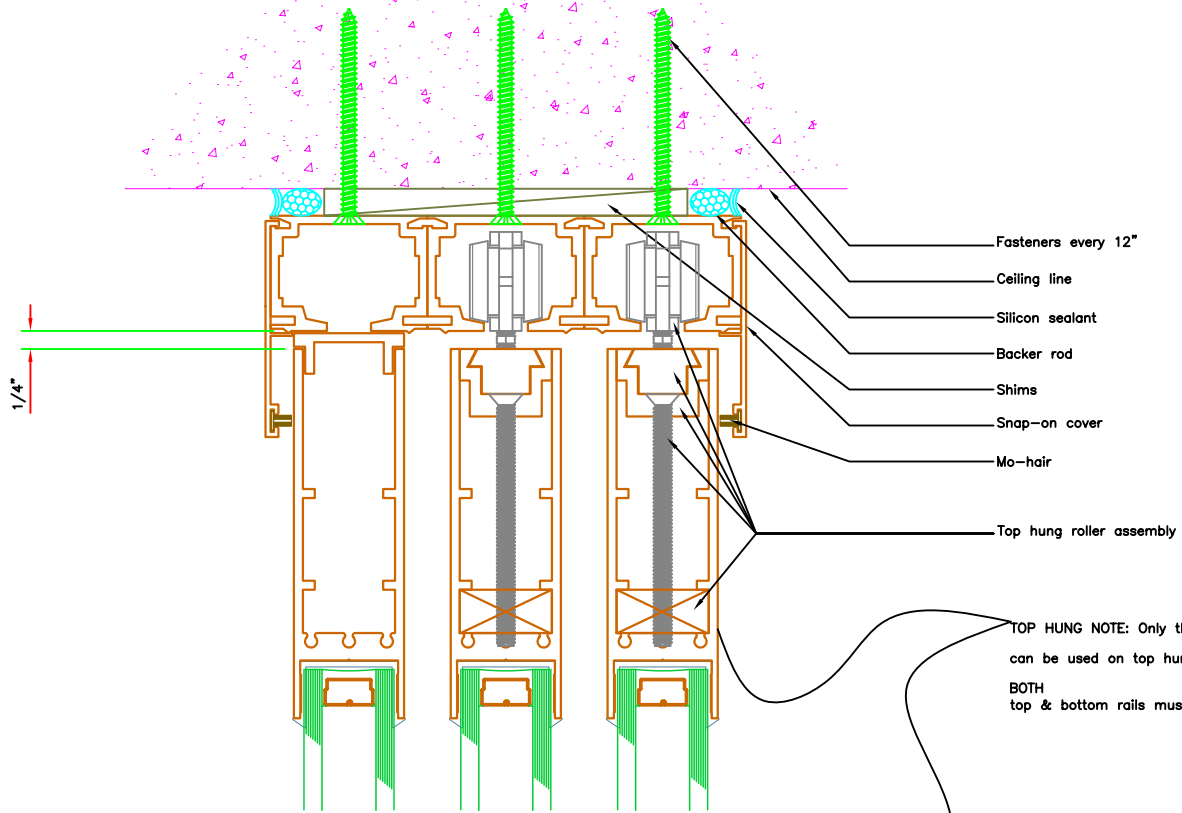

- Fasteners every 12"
- Ceiling line
- Silicon sealant
- Backer rod
- Shims
- Snap-on cover
- Mo-hair
- Top hung roller assembly

TOP HUNG NOTE: Only this rail "Die 2205" can be used on top hung
 BOTH top & bottom rails must be "Die 2205"

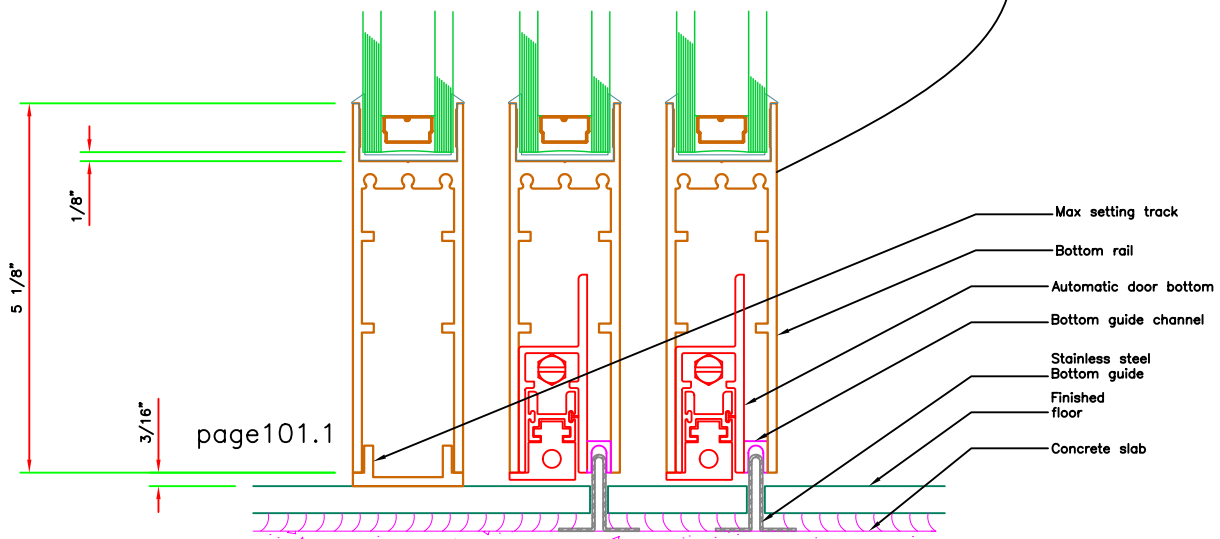

- Max setting track
- Bottom rail
- Automatic door bottom
- Bottom guide channel
- Stainless steel Bottom guide
- Finished floor
- Concrete slab

PRL GLASS SYSTEMS INC.

Web Site: www.prlglass.com www.prlaluminum.com

Telephone : (877) 775-25856 251 Mason Way
 Fax No. : (626) 968-95256 City of industry, C.A.

TITLE **MAX Slider**

details

MAX Slider
 XXO
 top hung
 vertical section
 1-1/4" I.G.

101.1



SCALE **XXXXX**

DATE **2/22/2011**

DRAWING NAME
MAX Slider details 1_1-4 IG.dwg

DRAFTPERSON **P**



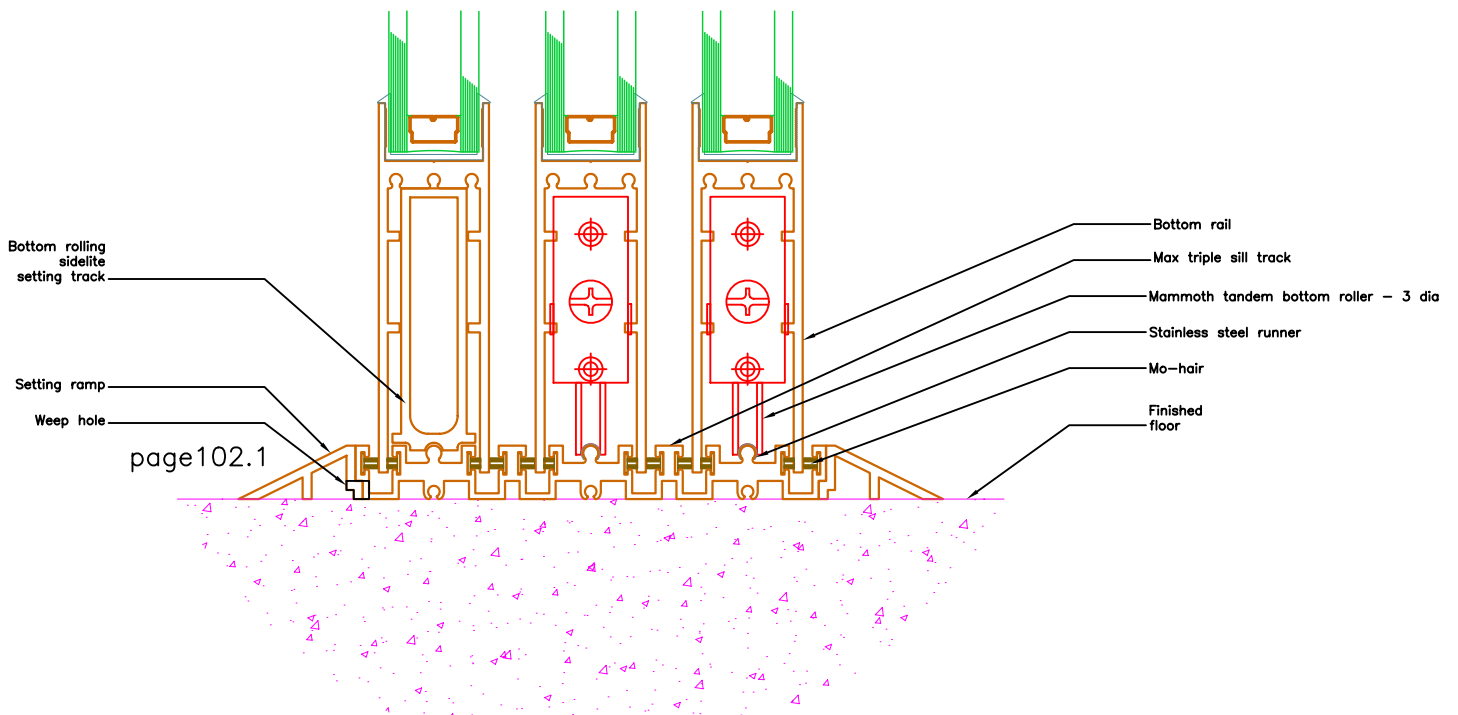
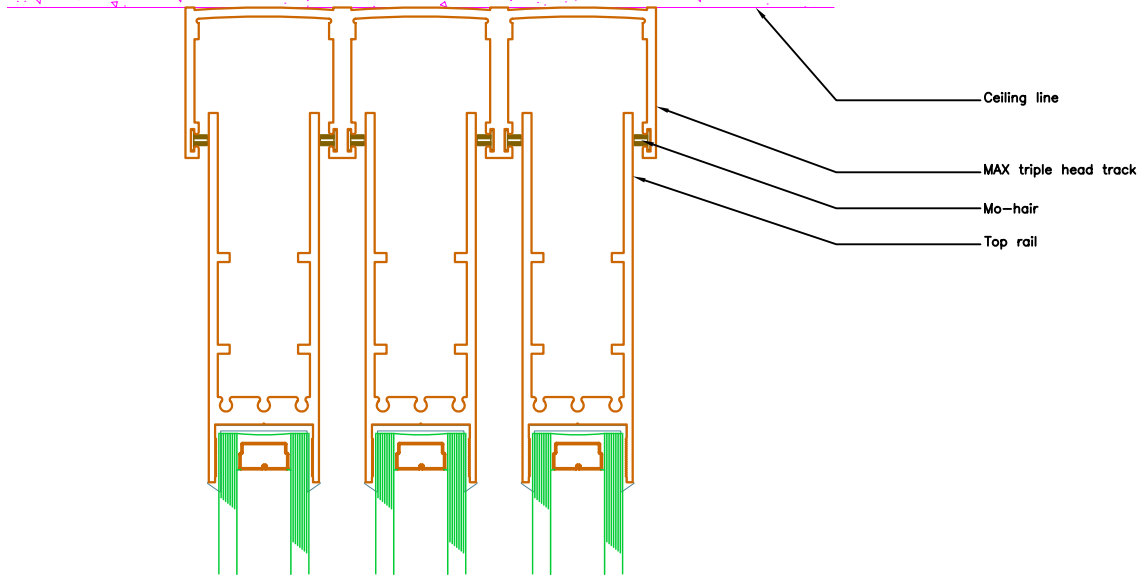

PRL GLASS SYSTEMS INC.

Web Site: www.prlglass.com

www.prlaluminum.com

Telephone : (877) 775-25856
Fax No. : (626) 968-95256

251 Mason Way
City of industry, C.A.

TITLE **MAX Slider**
details

MAX Slider
XXO
bottom rolling
vertical section
1-1/4" I.G.

102.1



SCALE **XXXXX**

DATE **2/22/2011**

DRAWING NAME
MAX Slider details 1_1-4 IG.dwg

DRAFTPERSON **P**



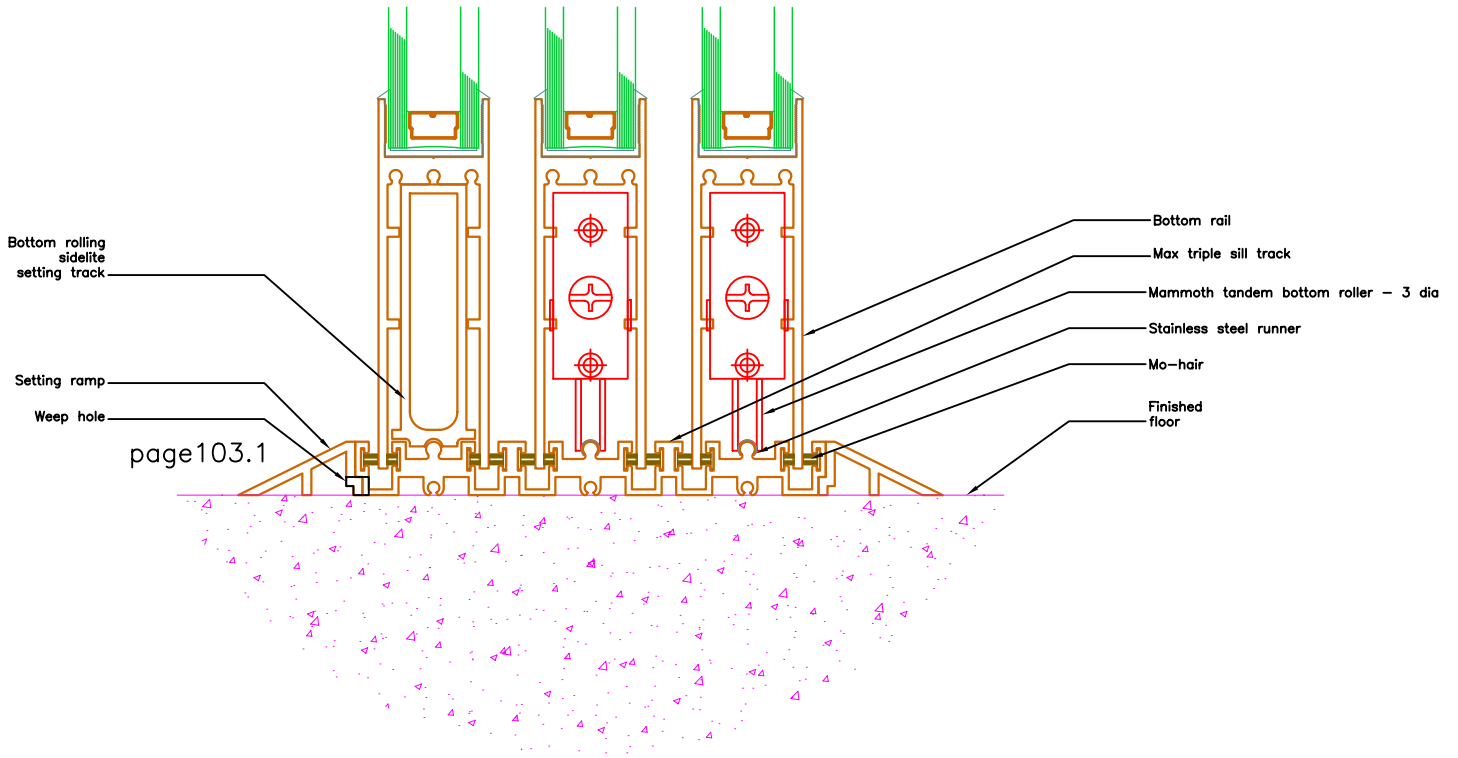
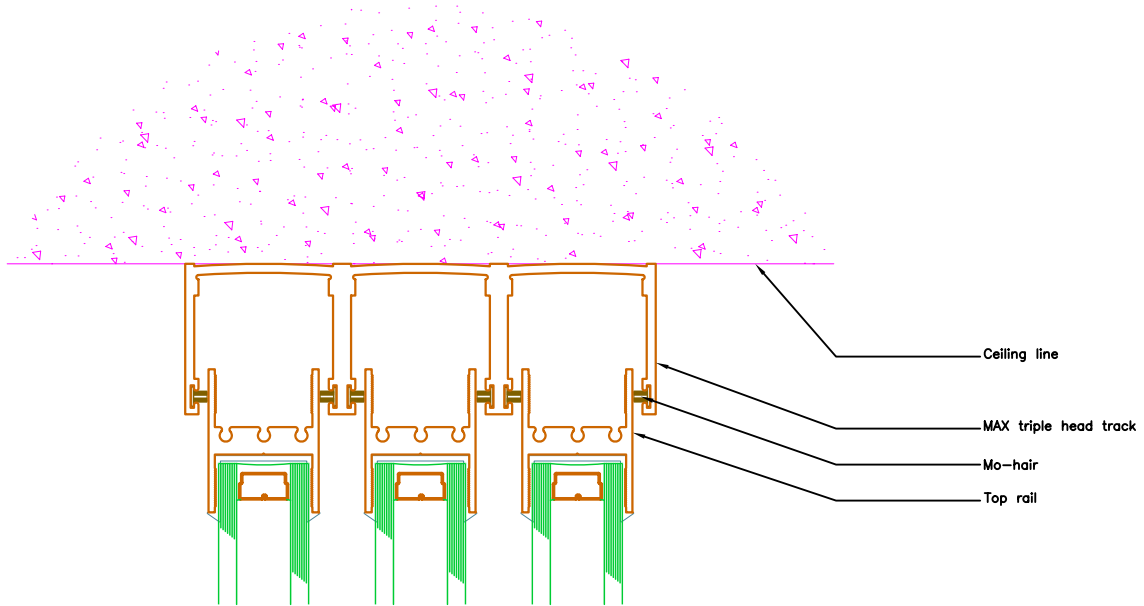

PRL GLASS SYSTEMS INC.

Web Site: www.prlglass.com

www.prlaluminum.com

Telephone : (877) 775-25856
Fax No. : (626) 968-95256

251 Mason Way
City of industry, C.A.

TITLE **MAX Slider**
details

MAX Slider
XXO
bottom rolling
vertical section
1-1/4" I.G.

103.1



SCALE **XXXXX**

DATE **2/22/2011**

DRAWING NAME
MAX Slider details 1_1-4 IG.dwg

DRAFTERPERSON **P**



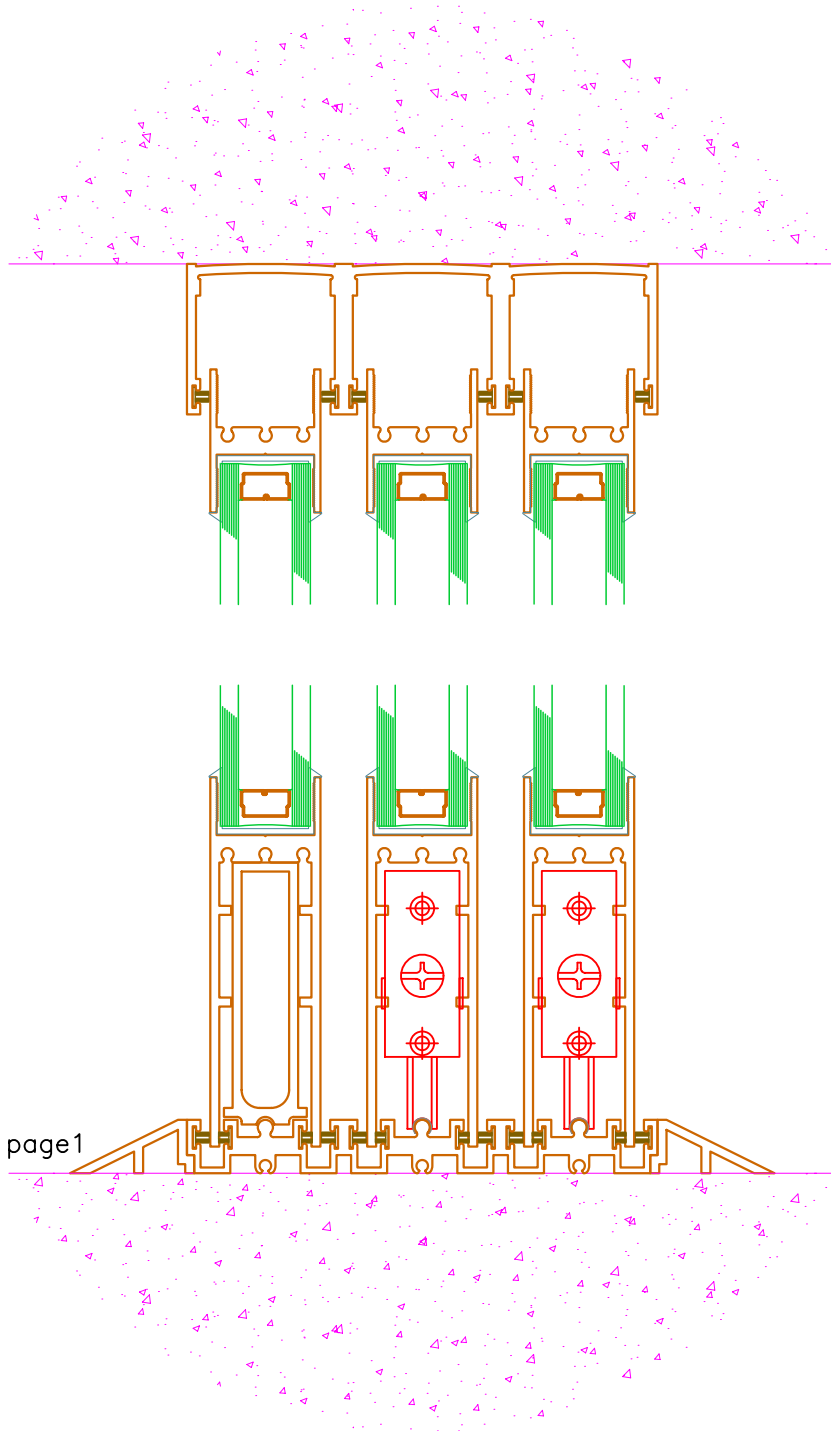

PRL GLASS SYSTEMS INC.

Web Site: www.prlglass.com

www.prlaluminum.com

Telephone : (877) 775-25856
 Fax No. : (626) 968-95256

251 Mason Way
 City of industry, C.A.

TITLE **MAX Slider**
details

MAX Slider
 XXO
 bottom rolling
 vertical section
 1-1/4" I.G.

02-22-11



SCALE **XXXXX**

DATE **2/22/2011**

DRAWING NAME
MAX Slider details 1_1-4 IG.dwg

DRAFTPERSON **P**



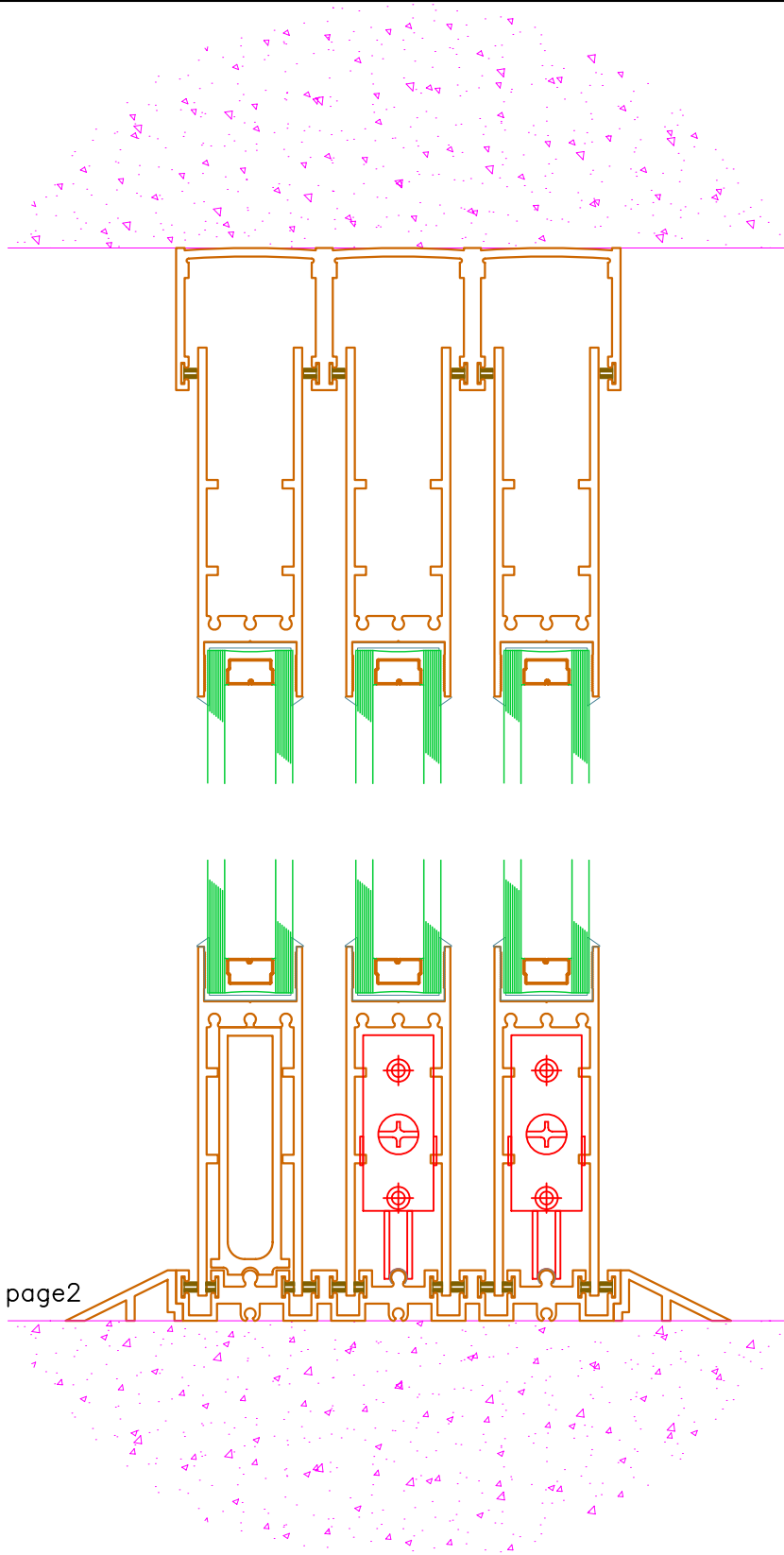

PRL GLASS SYSTEMS INC.

Web Site: www.prlglass.com

www.prlaluminum.com

Telephone : (877) 775-25856
 Fax No. : (626) 968-95256

251 Mason Way
 City of industry, C.A.

TITLE **MAX Slider**
details

MAX Slider
 XXO
 bottom rolling
 vertical section
 1-1/4" I.G.

02-22-11



SCALE **XXXXX**

DATE **2/22/2011**

DRAFTPERSON **P**



DRAWING NAME
MAX Slider details 1_1-4 IG.dwg

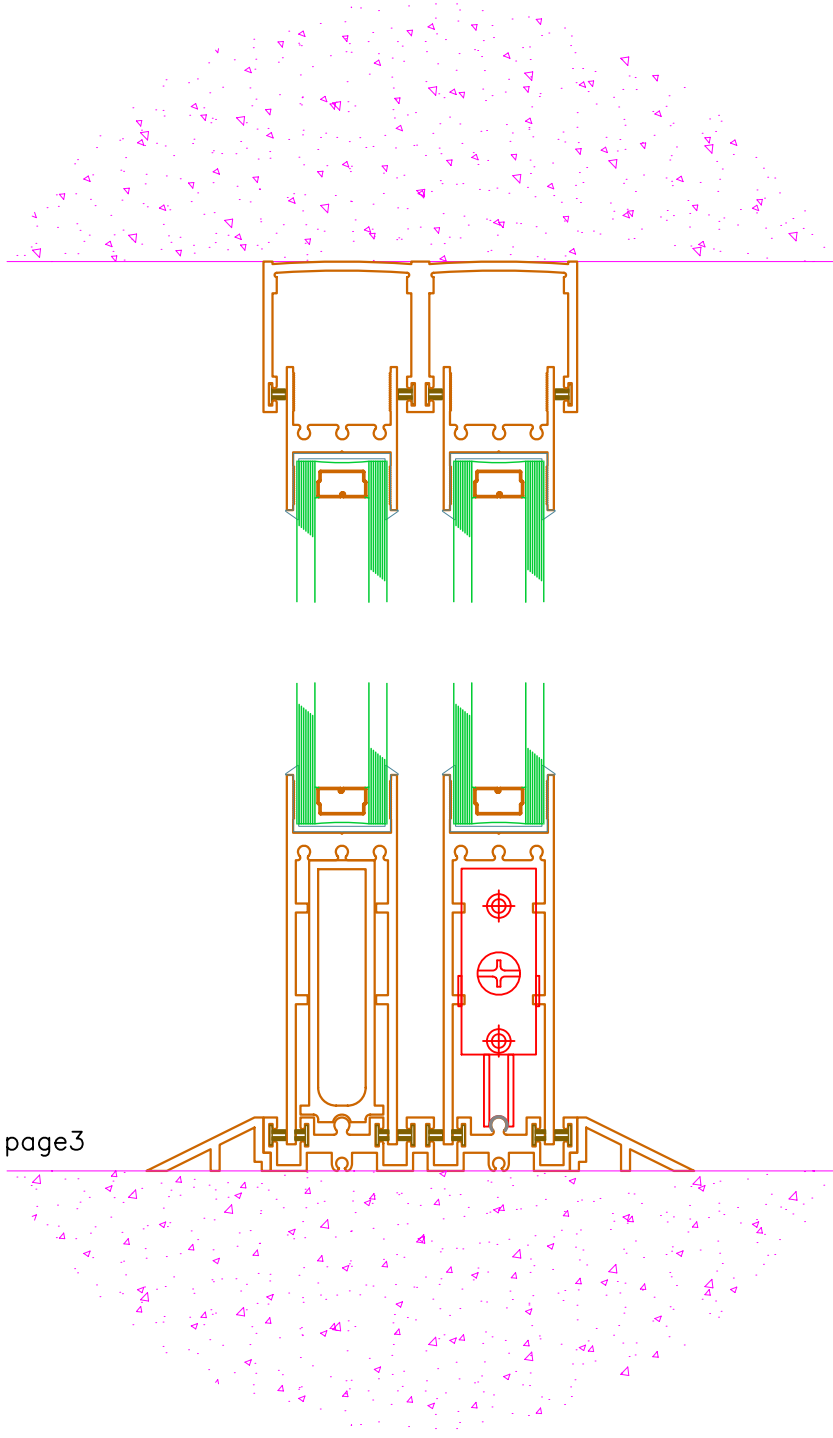

PRL GLASS SYSTEMS INC.

Web Site: www.prlglass.com

www.prlaluminum.com

Telephone : (877) 775-25856
 Fax No. : (626) 968-95256

251 Mason Way
 City of industry, C.A.

TITLE **MAX Slider**

details

MAX Slider
 XO
 bottom rolling
 vertical section
 1-1/4" I.G.

02-22-11



SCALE **XXXXX**

DATE **2/22/2011**

DRAWING NAME
MAX Slider details 1_1-4 IG.dwg

DRAFTERPERSON **P**



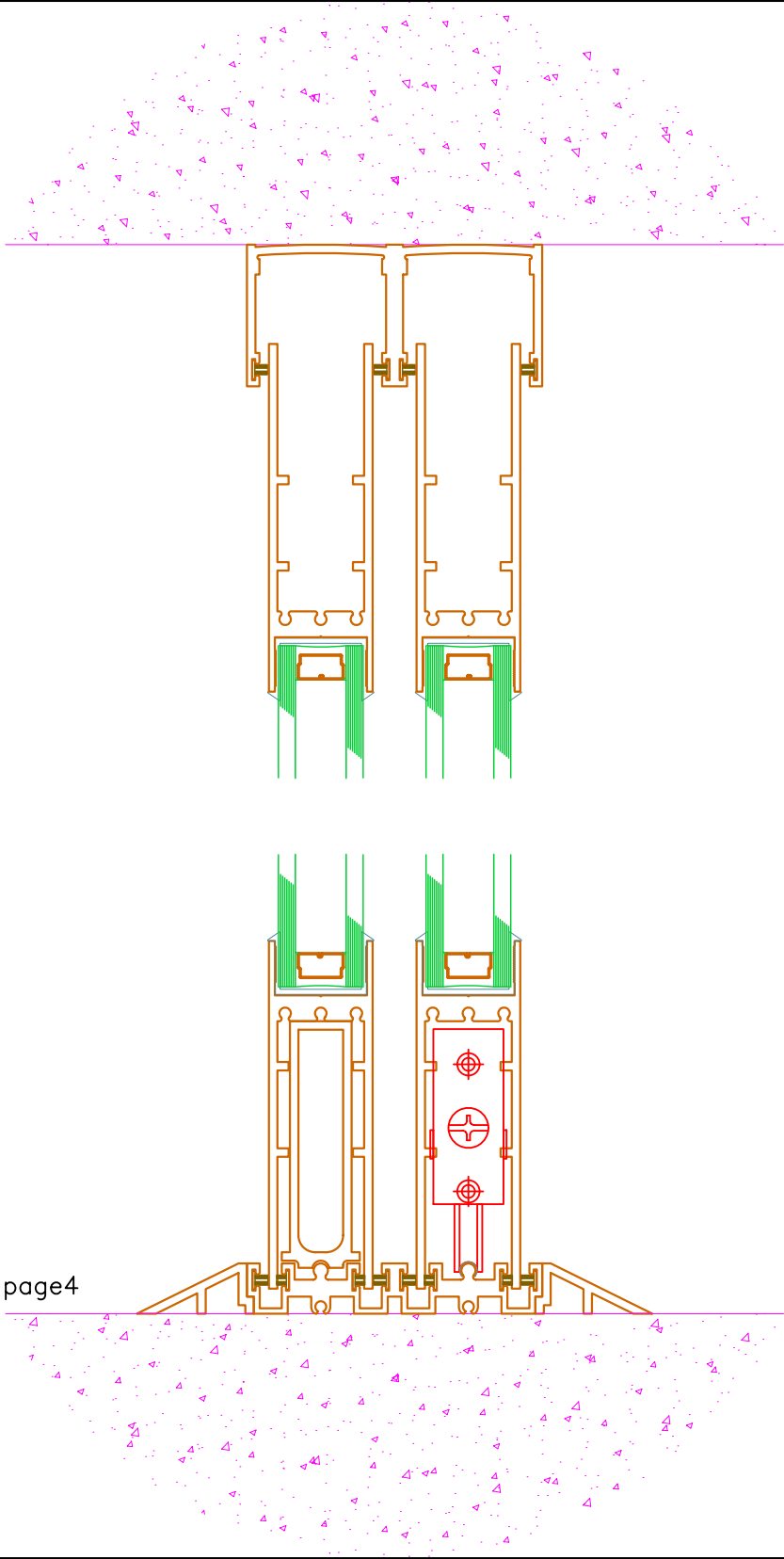

page4

PRL GLASS SYSTEMS INC.
 Web Site: www.prlglass.com

Telephone : (877) 775-25856 251 Mason Way
 Fax No. : (626) 968-95256 City of industry, C.A.



TITLE MAX Slider	
details	
SCALE XXXXX	DATE 2/22/2011
DRAFTPERSON P	

MAX Slider
 XO
 bottom rolling
 vertical section
 1-1/4" I.G.

DRAWING NAME
MAX Slider details 1_1-4 IG.dwg

02-22-11

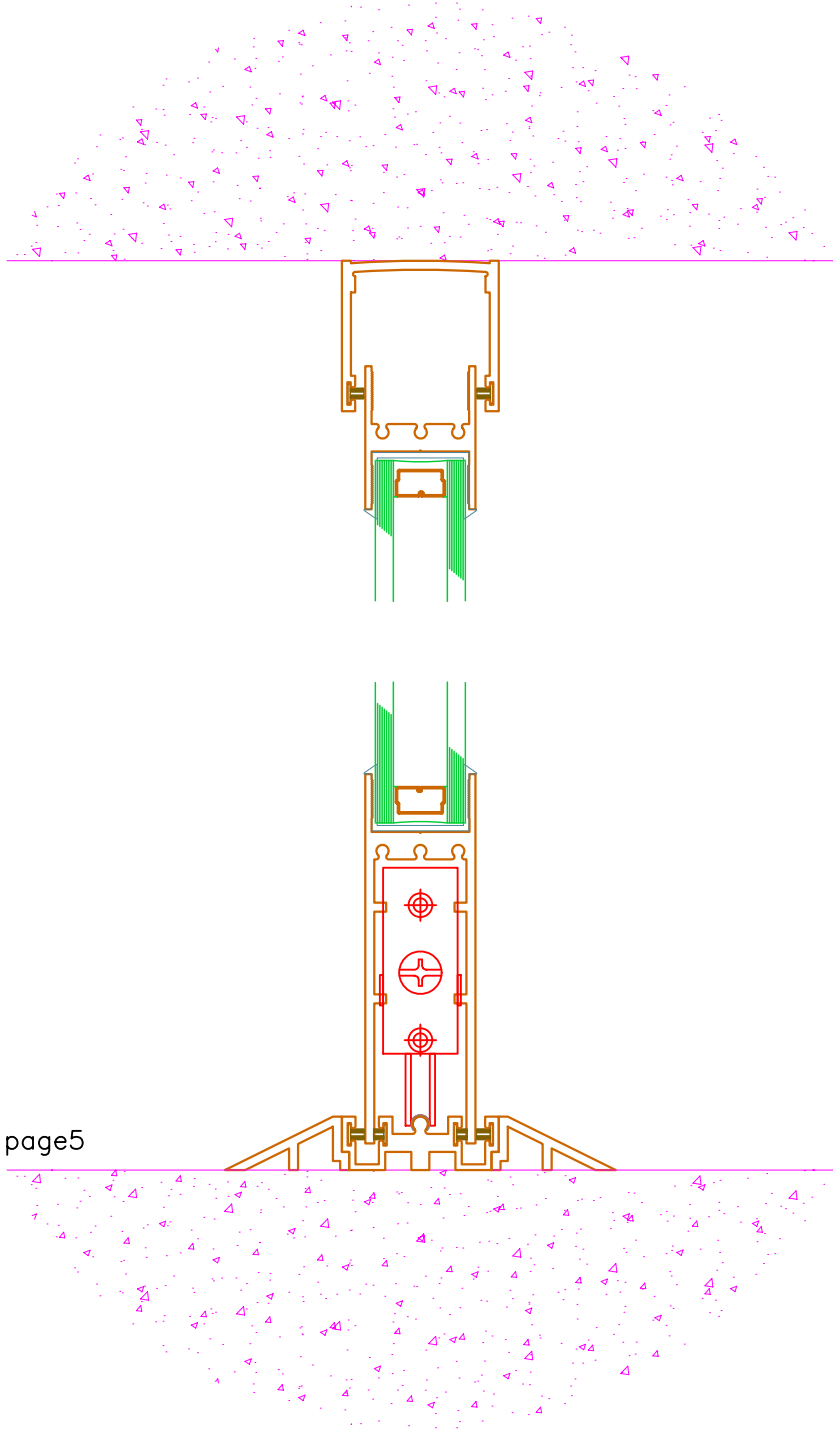

PRL GLASS SYSTEMS INC.

Web Site: www.prlglass.com

www.prlaluminum.com

Telephone : (877) 775-25856
 Fax No. : (626) 968-95256

251 Mason Way
 City of industry, C.A.

TITLE **MAX Slider**

details

MAX Slider
 X
 bottom rolling
 vertical section
 1-1/4" I.G.

02-22-11



SCALE **XXXXX**

DATE **2/22/2011**

DRAWING NAME
MAX Slider details 1_1-4 IG.dwg

DRAFTPERSON **P**



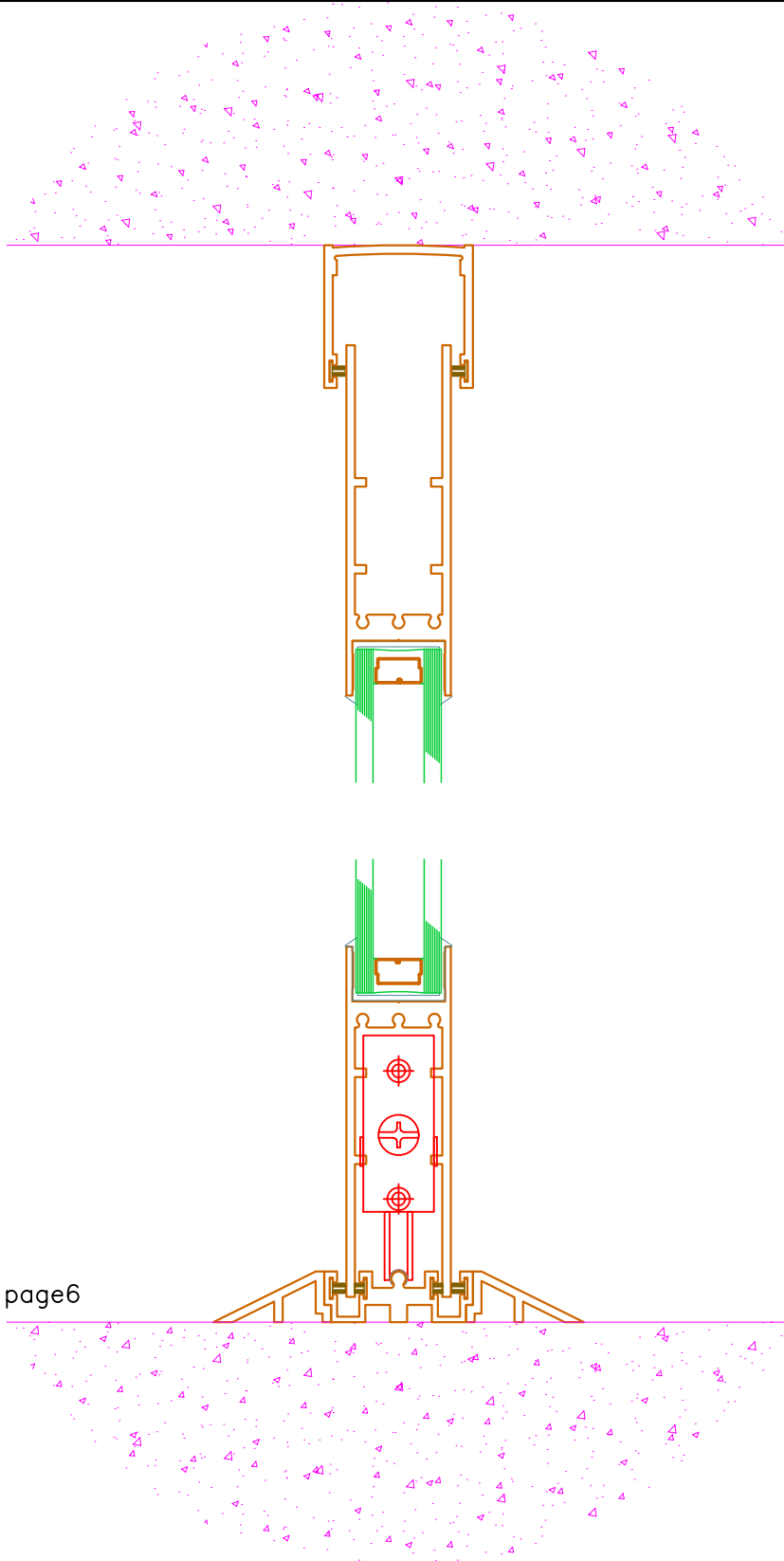

PRL GLASS SYSTEMS INC.

Web Site: www.prlglass.com

www.prlaluminum.com

Telephone : (877) 775-25856
 Fax No. : (626) 968-95256

251 Mason Way
 City of industry, C.A.

TITLE **MAX Slider**
details

MAX Slider
 X
 bottom rolling
 vertical section
 1-1/4" I.G.

02-22-11



SCALE **XXXXX**

DATE **2/22/2011**

DRAWING NAME
MAX Slider details 1_1-4 IG.dwg

DRAFTPERSON **P**



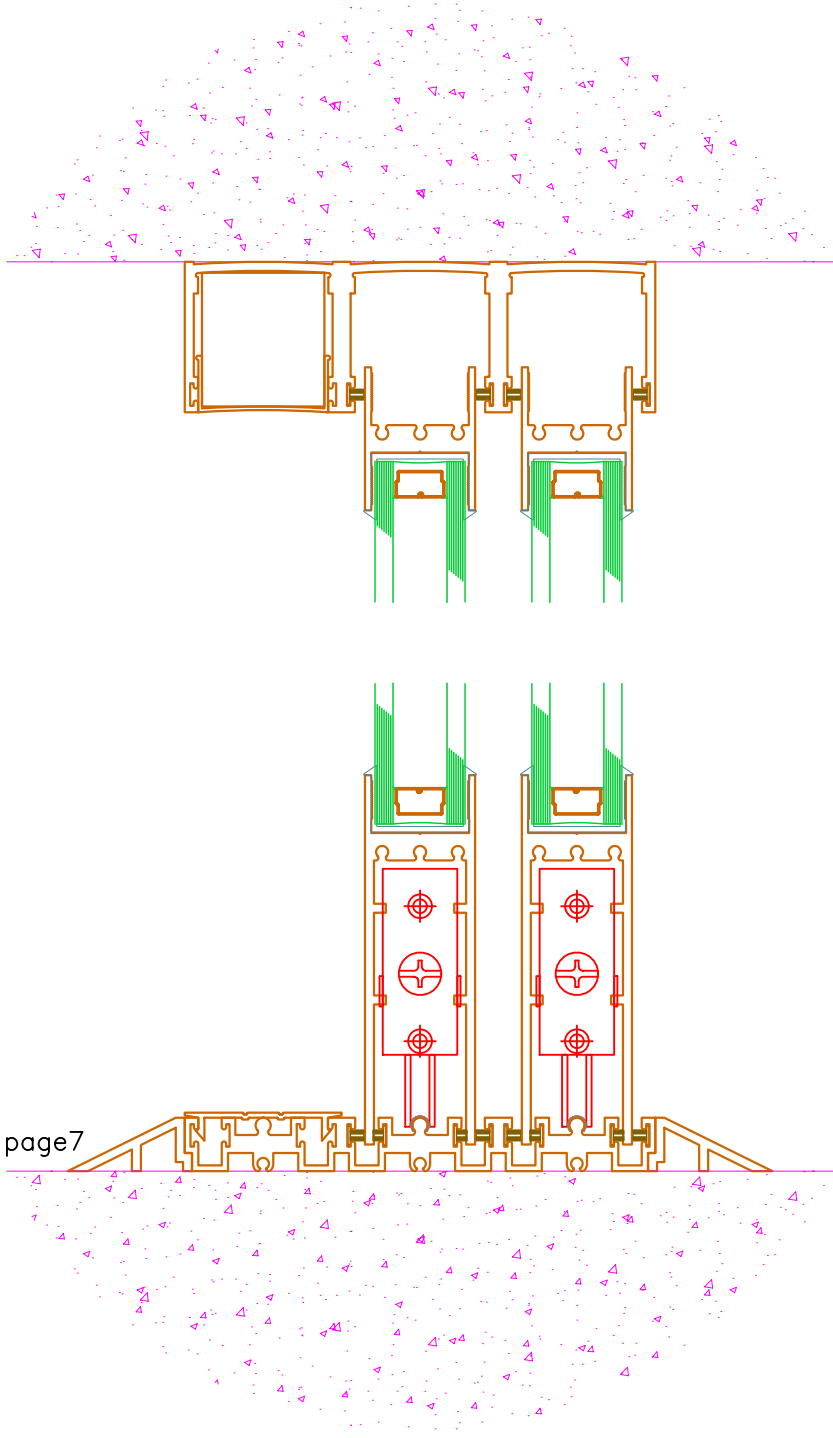

PRL GLASS SYSTEMS INC.

Web Site: www.prlglass.com

www.prlaluminum.com

Telephone : (877) 775-25856
 Fax No. : (626) 968-95256

251 Mason Way
 City of industry, C.A.

TITLE **MAX Slider**
details

MAX Slider
 XXO
 bottom rolling
 vertical section
 1-1/4" I.G.

02-22-11



SCALE **XXXXX**

DATE **2/22/2011**

DRAWING NAME
MAX Slider details 1_1-4 IG.dwg

DRAFTPERSON **P**



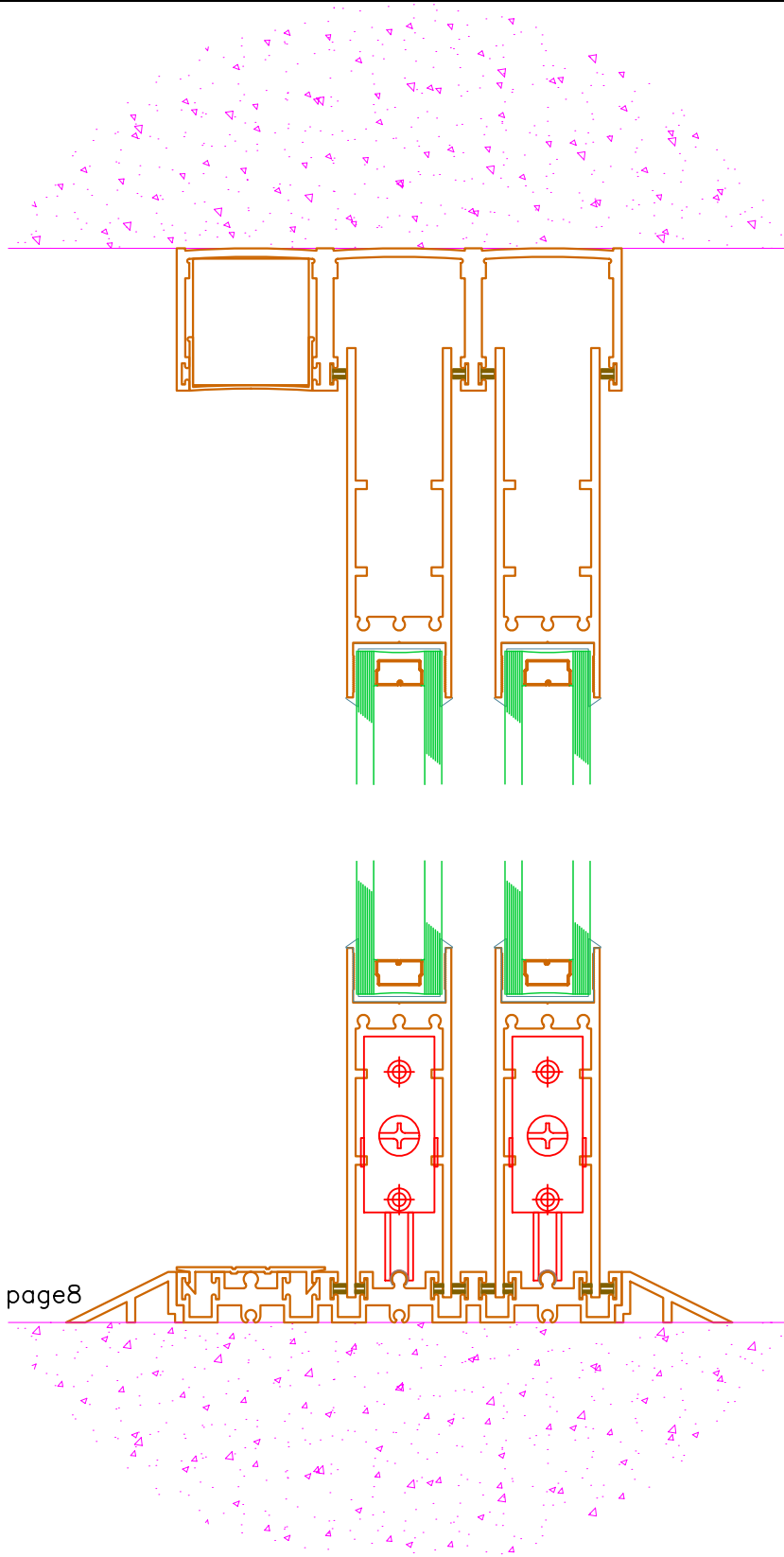

PRL GLASS SYSTEMS INC.

Web Site: www.prlglass.com

www.prlaluminum.com

Telephone : (877) 775-25856
 Fax No. : (626) 968-95256

251 Mason Way
 City of industry, C.A.

TITLE **MAX Slider**
details

MAX Slider
 XXO
 bottom rolling
 vertical section
 1-1/4" I.G.

02-22-11



SCALE **XXXXX**

DATE **2/22/2011**

DRAWING NAME
MAX Slider details 1_1-4 IG.dwg

DRAFTPERSON **P**



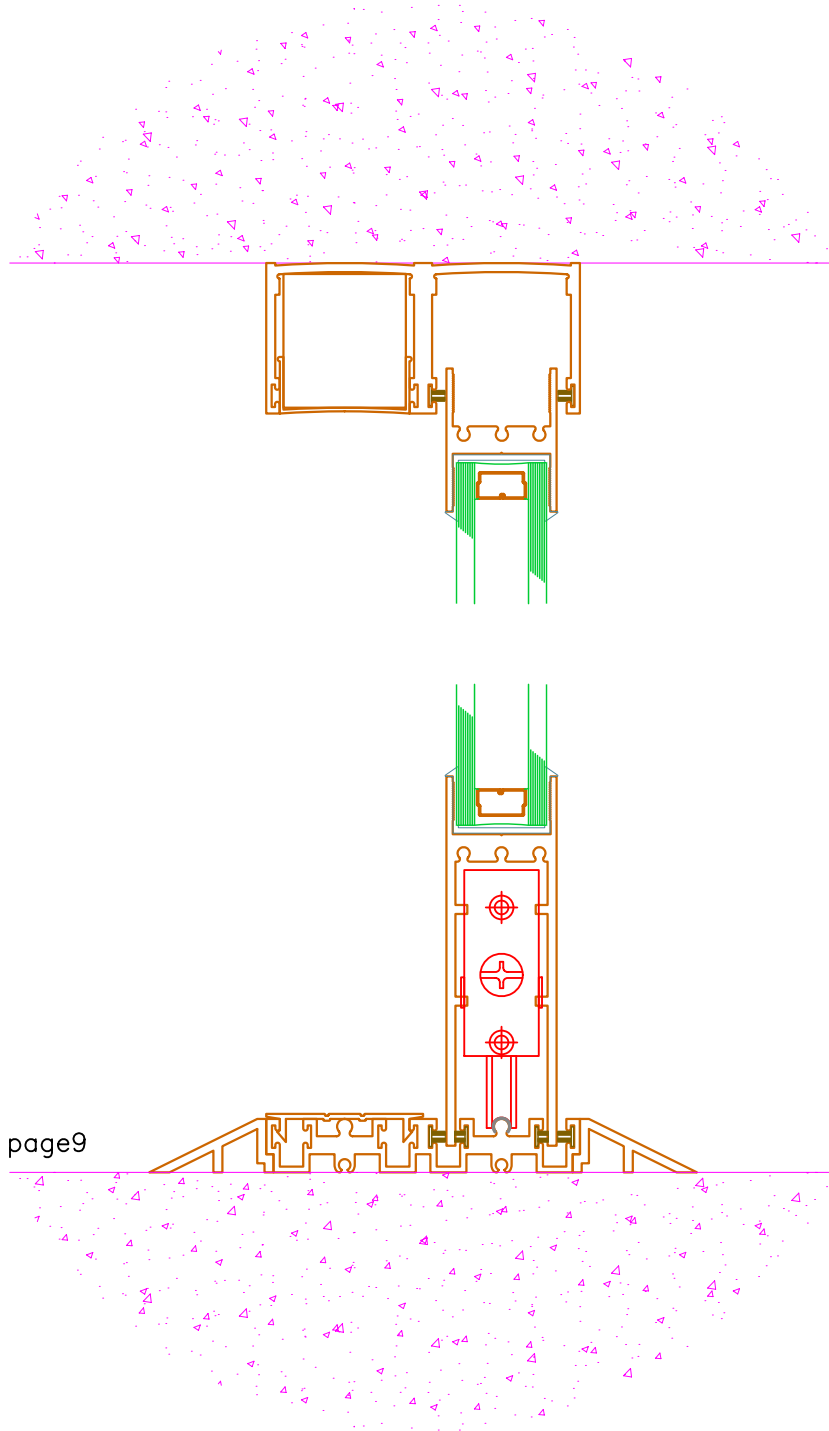

PRL GLASS SYSTEMS INC.

Web Site: www.prlglass.com

www.prlaluminum.com

Telephone : (877) 775-25856
Fax No. : (626) 968-95256

251 Mason Way
City of industry, C.A.

TITLE **MAX Slider**

details

MAX Slider
XO
bottom rolling
vertical section
1-1/4" I.G.

02-22-11



SCALE **XXXXX**

DATE **2/22/2011**

DRAFTPERSON **P**



DRAWING NAME

MAX Slider details 1_1-4 IG.dwg

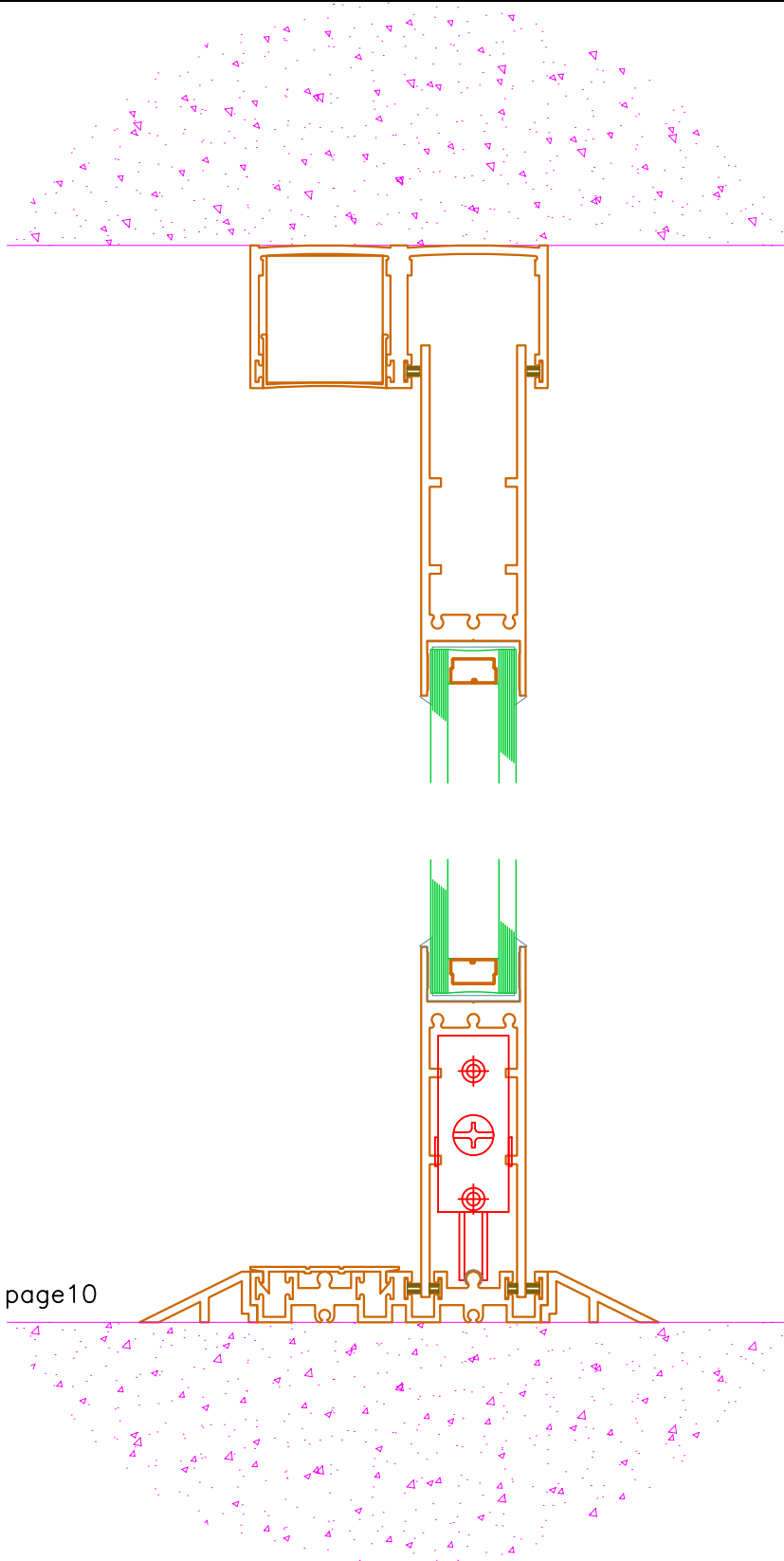

PRL GLASS SYSTEMS INC.

Web Site: www.prlglass.com

www.prlaluminum.com

Telephone : (877) 775-25856
Fax No. : (626) 968-95256

251 Mason Way
City of industry, C.A.

TITLE **MAX Slider**
details

MAX Slider
XO
bottom rolling
vertical section
1-1/4" I.G.

02-22-11



SCALE **XXXXX**

DATE **2/22/2011**

DRAWING NAME
MAX Slider details 1_1-4 IG.dwg

DRAFTPERSON **P**



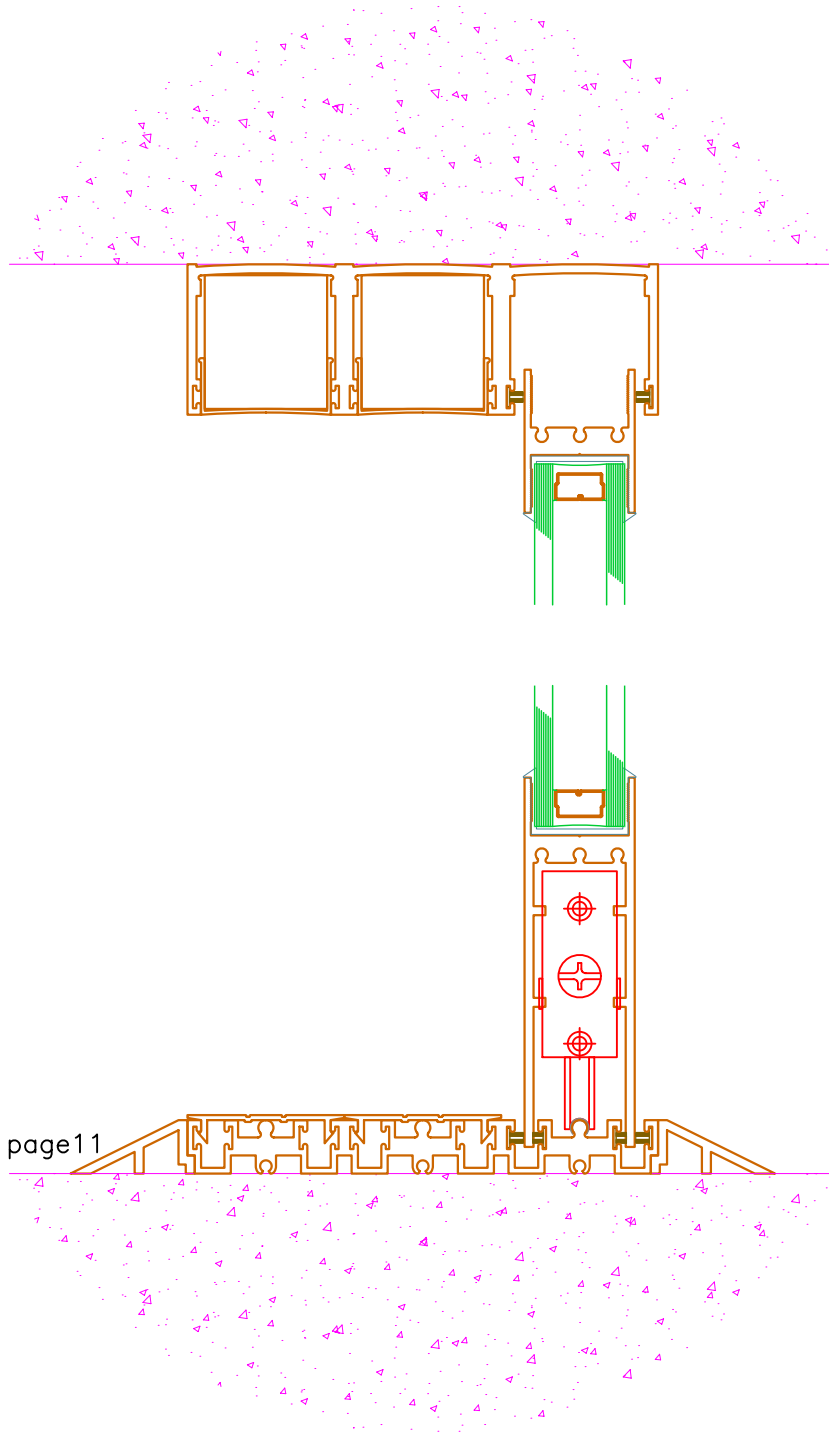

PRL GLASS SYSTEMS INC.

Web Site: www.prlglass.com

www.prlaluminum.com

Telephone : (877) 775-25856
Fax No. : (626) 968-95256

251 Mason Way
City of industry, C.A.

TITLE **MAX Slider**

details

SCALE **XXXXX**

DATE **2/22/2011**

DRAFTPERSON **P**



MAX Slider
XXO

bottom rolling
vertical section
1-1/4" I.G.

DRAWING NAME

MAX Slider details 1_1-4 IG.dwg

02-22-11

PRL GLASS SYSTEMS INC.



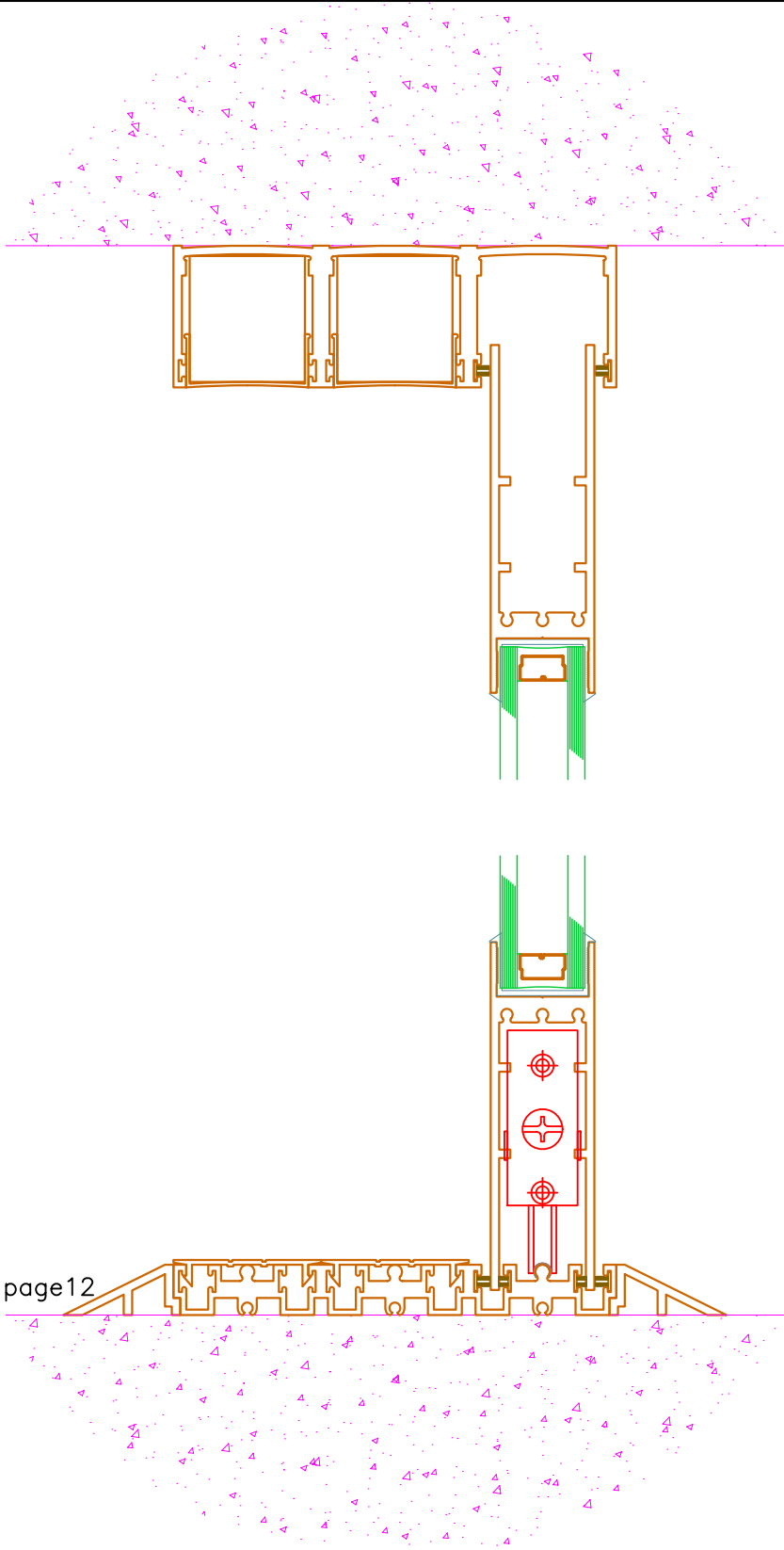

page12

PRL GLASS SYSTEMS INC.

Web Site: www.prlglass.com

www.prlaluminum.com

Telephone : (877) 775-25856
 Fax No. : (626) 968-95256

251 Mason Way
 City of industry, C.A.

TITLE **MAX Slider**

details

MAX Slider
 XXO
 bottom rolling
 vertical section
 1-1/4" I.G.

02-22-11



SCALE **XXXXX**

DATE **2/22/2011**

DRAWING NAME
MAX Slider details 1_1-4 IG.dwg

DRAFTPERSON **P**

